

# MMS DATA MODEL PACKAGE SUMMARY

MMS Data Model v4.27 Oracle

PREPARED BY: IMT

DATE: 14/11/2017

## Table of Contents

<b>1</b>	<b>List of packages</b>	<b>2</b>
<b>2</b>	<b>Description of model MMS Data Model v4.27 Oracle4</b>	
<b>3</b>	<b>Package: ANCILLARY_SERVICES</b>	<b>6</b>
3.1	List of tables	6
3.2	Diagram: Entities: Ancillary Services	6
<b>4</b>	<b>Package: ASOFFER</b>	<b>7</b>
4.1	List of tables	7
4.2	Diagram: Entities: Ancillary Service Contracts	7
<b>5</b>	<b>Package: BIDS</b>	<b>8</b>
5.1	List of tables	8
5.2	Diagram: Entities: Bids	9
<b>6</b>	<b>Package: BILLING_CONFIG</b>	<b>10</b>
6.1	List of tables	10
6.2	Diagram: Entities: Billing Config	11
<b>7</b>	<b>Package: BILLING_RUN</b>	<b>12</b>
7.1	List of tables	12
7.2	Diagram: Entities: Billing Run	15
<b>8</b>	<b>Package: CONFIGURATION</b>	<b>16</b>
8.1	List of tables	16
8.2	Diagram: Entities: Configuration	16
<b>9</b>	<b>Package: DEMAND_FORECASTS</b>	<b>17</b>
9.1	List of tables	17
9.2	Diagram: Entities: Demand Forecasts	18
<b>10</b>	<b>Package: DISPATCH</b>	<b>19</b>
10.1	List of tables	19
10.2	Diagram: Entities: Dispatch	21
<b>11</b>	<b>Package: FORCE_MAJEURE</b>	<b>22</b>
11.1	List of tables	22
11.2	Diagram: Entities: Force Majeure	23
<b>12</b>	<b>Package: GD_INSTRUCT</b>	<b>24</b>
12.1	List of tables	24
12.2	Diagram: Entities: GD Instruct	24
<b>13</b>	<b>Package: GENERIC_CONSTRAINT</b>	<b>25</b>

13.1	List of tables	25
13.2	Diagram: Entities: Generic Constraints	26
<b>14</b>	<b>Package: HISTORICAL TABLES</b>	<b>27</b>
14.1	List of tables	27
14.2	Diagram: Entities: Historical Tables	32
<b>15</b>	<b>Package: IRAUCTION</b>	<b>33</b>
15.1	List of tables	33
15.2	Diagram: Entities: IRAuction	35
<b>16</b>	<b>Package: MARKET_CONFIG</b>	<b>36</b>
16.1	List of tables	36
16.2	Diagram: Entities: Market Standing Data	37
<b>17</b>	<b>Package: MARKET_NOTICE</b>	<b>38</b>
17.1	List of tables	38
17.2	Diagram: Entities: Market Notices	38
<b>18</b>	<b>Package: MCC_DISPATCH</b>	<b>39</b>
18.1	List of tables	39
18.2	Diagram: Entities: MCC_Dispatch	39
<b>19</b>	<b>Package: METER_DATA</b>	<b>40</b>
19.1	List of tables	40
19.2	Diagram: Entities: Meter Data	41
<b>20</b>	<b>Package: MREVENT</b>	<b>42</b>
20.1	List of tables	42
20.2	Diagram: Entities: MR Events	43
<b>21</b>	<b>Package: MTPASA</b>	<b>44</b>
21.1	List of tables	44
21.2	Diagram: Entities: MT PASA	45
<b>22</b>	<b>Package: NETWORK</b>	<b>46</b>
22.1	List of tables	46
22.2	Diagram: Entities: NETWORK	47
<b>23</b>	<b>Package: P5MIN</b>	<b>48</b>
23.1	List of tables	48
23.2	Diagram: Entities: P5MIN	49
<b>24</b>	<b>Package: PARTICIPANT_REGISTRATION</b>	<b>50</b>
24.1	List of tables	50
24.2	Diagram: Entities: Participant Registration	51
<b>25</b>	<b>Package: PDPASA</b>	<b>52</b>

<b>25.1</b>	<b>List of tables</b>	<b>52</b>
<b>25.2</b>	<b>Diagram: Entities: PD PASA</b>	<b>52</b>
<b>26</b>	<b>Package: PRE_DISPATCH</b>	<b>53</b>
<b>26.1</b>	<b>List of tables</b>	<b>54</b>
<b>26.2</b>	<b>Diagram: Entities: Predispatch</b>	<b>56</b>
<b>27</b>	<b>Package: PRUDENTIALS</b>	<b>57</b>
<b>27.1</b>	<b>List of tables</b>	<b>57</b>
<b>27.2</b>	<b>Diagram: Entities:Prudentials</b>	<b>57</b>
<b>28</b>	<b>Package: RESERVE_DATA</b>	<b>58</b>
<b>28.1</b>	<b>List of tables</b>	<b>58</b>
<b>28.2</b>	<b>Diagram: Entities: Reserve Data</b>	<b>59</b>
<b>29</b>	<b>Package: SETTLEMENT_CONFIG</b>	<b>60</b>
<b>29.1</b>	<b>List of tables</b>	<b>60</b>
<b>29.2</b>	<b>Diagram: Entities: Settlement Config</b>	<b>61</b>
<b>30</b>	<b>Package: SETTLEMENT_DATA</b>	<b>62</b>
<b>30.1</b>	<b>List of tables</b>	<b>62</b>
<b>30.2</b>	<b>Diagram: Entities: Settlement Data</b>	<b>64</b>
<b>31</b>	<b>Package: STPASA_SOLUTION</b>	<b>66</b>
<b>31.1</b>	<b>List of tables</b>	<b>66</b>
<b>31.2</b>	<b>Diagram: Entities: ST PASA Solution</b>	<b>66</b>
<b>32</b>	<b>Package: TRADING_DATA</b>	<b>67</b>
<b>32.1</b>	<b>List of tables</b>	<b>67</b>
<b>32.2</b>	<b>Diagram: Entities: Trading Data</b>	<b>67</b>
<b>33</b>	<b>Package: VOLTAGE_INSTRUCTIONS</b>	<b>68</b>
<b>33.1</b>	<b>List of tables</b>	<b>68</b>
<b>33.2</b>	<b>Diagram: Entities: Voltage Instructions</b>	<b>68</b>

## Disclaimer

This document is made available to you on the following basis:

(a) Purpose - This document is provided by the Australian Energy Market Operator Limited (AEMO) to you for information purposes only. You are not permitted to commercialise it or any information contained in it.

(b) No Reliance or warranty - This document may be subsequently amended. AEMO does not warrant or represent that the data or information in this document is accurate, reliable, complete or current or that it is suitable for particular purposes. You should verify and check the accuracy, completeness, reliability and suitability of this document for any use to which you intend to put it and seek independent expert advice before using it, or any information contained in it.

(c) Limitation of liability - To the extent permitted by law, AEMO and its advisers, consultants and other contributors to this document (or their respective associated companies, businesses, partners, directors, officers or employees) shall not be liable for any errors, omissions, defects or misrepresentations in the information contained in this document, or for any loss or damage suffered by persons who use or rely on such information (including by reason of negligence, negligent misstatement or otherwise). If any law prohibits the exclusion of such liability, AEMO's liability is limited, at AEMO's option, to the re-supply of the information, provided that this limitation is permitted by law and is fair and reasonable.

© 2010 - All rights reserved.

## 1 List of packages

Name	Comment
CONFIGURATION	MMS Data Model Configuration Management and Control
ANCILLARY_SERVICES	Ancillary Service Contract Data
ASOFFER	Offer data for Ancillary Service Contracts
BIDS	Energy and Market Based FCAS Offers
BILLING_CONFIG	Configuration data for the Billing Process
BILLING_RUN	<p>Results from a published Billing Run. The settlement data and billing run data are updated daily between 6am and 8am for AEMO's prudential processes. In a normal week, AEMO publishes one PRELIM, one FINAL and two REVISION runs in addition to the daily runs.</p> <p>Each billing run is uniquely identified by contract year, week no and bill run no.</p>
DEMAND_FORECASTS	Regional Demand Forecasts and Intermittent Generation forecasts.
DISPATCH	Results from a published Dispatch Run
FORCE_MAJEURE	Market Suspensions and administer pricing event data
GD_INSTRUCT	General Dispatch Instruction data
GENERIC_CONSTRAINT	Generic Constraint Standing Data and Invocations
IRAUCTION	Inter-regional Residue Auction data
MARKET_CONFIG	Standing data for the market
MARKET_NOTICE	Market Notice data
METER_DATA	Wholesale market aggregated Meter data
MREVENT	Mandatory Restrictions Event data
MTPASA	Results from a published Medium Term PASA Run and region-aggregate offered PASA Availability of scheduled generators
P5MIN	Results from a published Five-Minute Predispatch Run
PARTICIPANT_REGISTRATION	Participant registration data
PRE_DISPATCH	<p>Results from a published Predispatch Run</p> <p>Storage options There are 2 ways to define the Pre-dispatch table primary keys (PKs) to define which data is loaded to the database and which data is retained:</p> <p>Option 1 (default) Overwrite older records when they are succeeded by later versions for the same entity and period. This is the Data Model default and results in the consumption of far less storage. Data Model updates issued by AEMO target this configuration so participants implementing option 2a or 2b must maintain their changes when AEMO releases a new Data Model version.</p>

	<p>PredispatchLoad: DateTime, DUID                  PredispatchInterconnectorRes: DateTime, InterconnectorID,                  PredispatchPrice: DateTime, RegionID                  PredispatchPriceSensitivities: DateTime, RegionID                  PredispatchInterSensitivities: InterconnectorID, DateTime</p> <p>Option 2a                  Retain only the Pricing records for tables relating to Price data and Physical records for tables relating to Physical data (e.g. targets). Approximately 50 times more storage volumes than option 1.                  PredispatchLoad: PredispatchSeqNo, DateTime, DUID                  PredispatchInterconnectorRes: PredispatchSeqNo, DateTime, InterconnectorID,                  PredispatchPrice: PredispatchSeqNo, DateTime, RegionID                  PredispatchPriceSensitivities: PredispatchSeqNo, DateTime, RegionID                  PredispatchInterSensitivities: PredispatchSeqNo, DateTime, InterconnectorID</p> <p>Option 2b                  Retain both Physical and Pricing data for Intervention runs. If Intervention cases are stored in entirety, you must select the data carefully. The logic is the same as for Dispatch, i.e. Intervention Pricing is always where Intervention = 0 and Physical data is where Intervention = PredispatchCaseSolution.Intervention for the same PredispatchSeqNo.                  Doubles the storage of option 2a but ONLY for Intervened cases.                  PredispatchLoad: PredispatchSeqNo, Intervention, DateTime, DUID                  PredispatchInterconnectorRes: PredispatchSeqNo, Intervention, DateTime, InterconnectorID,                  PredispatchPrice: PredispatchSeqNo, Intervention, DateTime, RegionID                  PredispatchPriceSensitivities: PredispatchSeqNo, Intervention, DateTime, RegionID                  PredispatchInterSensitivities: PredispatchSeqNo, Intervention, DateTime, InterconnectorID</p> <p>Notes:                  The data in the PredispatchIS file is always ordered so the pdrLoader overwrites earlier data or adds each data set in its entirety, depending on how the PKs are defined.                  You may order the PKs in a different order, depending on your local requirements. Any decision to change the PK column composition or order must consider the functional and performance impacts to existing applications or queries.                  The pdrLoader caches PK definitions for performance reasons so any change to the PKs requires a restart of the application.                  The TRANSACTION_TYPE default in the PDR_REPORT_RECORDS management tables for PREDISPATCH* tables is UPDATE-INSERT. You can modify this to INSERT for Option 2b, as the attempt to first perform an update becomes redundant. This can improve load performance.</p>
RESERVE_DATA	Energy and FCAS reserve requirements
SETTLEMENT_CONFIG	Configuration and input data for the Settlements Process
SETTLEMENT_DATA	Results from a published Settlements Run. The settlement data and

	billing run data are updated daily between 6am and 8am for AEMO's prudential processes. In a normal week, AEMO publishes one PRELIM, one FINAL and two REVISION runs in addition to the daily runs.
STPASA_SOLUTION	Results from a published Short Term PASA Run
TRADING_DATA	30 minute Trading interval results
HISTORICAL TABLES	These tables are no longer used
PDPASA	The PDPASA package provides a 30-minute solving process to the Market systems The current methodology for calculating reserves in the PreDispatch timeframe is determined in a post processing step using a heuristic calculation based the results and Interconnector limits from the PreDispatch run. The calculation is a reserve assessment based on the PASA solver similar to existing ST and MT PASA business processes The process reflects all intra-regional and inter-regional network constraints as an input to the process
PRUDENTIALS	Prudential Management
MCC_DISPATCH	Results from the Marginal Constraint Cost (MCC) re-run of the dispatch process. The MCC forms part of the part of the AER's "Electricity transmission network service providers Service target performance incentive Scheme"
NETWORK	Configuration data for the physical network
VOLTAGE_INSTRUCTIONS	Instructions for MVar Dispatch

## 2 Description of model MMS Data Model v4.27 Oracle

### Background

The MMS Data Model is the definition of the interface to participants of data published by AEMO from the NEM system. A database conforming to the MMS Data Model can contain a local copy of all current participant-specific data recorded in the main NEM production database. The target databases have been called such names as the Participant Database, the Participant InfoServer and the Replica Database.

The MMS Data Model includes database tables, indexes and primary keys. The model is currently exposed as a physical model, so is different in presentation for each RDBMS. However, the same logical model underlies all the physical models published by AEMO.

The MMS Data Model is the target model for products transferring data from AEMO to each participant. Current product supplied by AEMO for data transfer is Participant Data Replication (PDR), with some support for the superseded Parser.

Compatibility of the transfer products with the MMS Data Model is the responsibility of those products and their configuration. AEMO's intention is to supply the data transfer products pre-configured to deliver data consistent with the MMS Data Model, noting differences where they occur (e.g. for historical reasons).

### Entity Diagrams

The entity diagrams show the key columns. Relationships have now been included in many cases.



**Note:**

The National Electricity Market registration classification of Yarwun Power Station Unit 1 (dispatchable unit ID: YARWUN\_1) is market non-scheduled generating unit. However, it is a condition of the registration of this unit that the Registered Participant complies with some of the obligations of a Scheduled Generator. This unit is dispatched as a scheduled generating unit with respect to its dispatch offers, targets and generation outputs. Accordingly, information about YARWUN\_1 is reported as scheduled generating unit information.

### 3 Package: ANCILLARY\_SERVICES

*Name*                    ANCILLARY\_SERVICES  
*Comment*                Ancillary Service Contract Data

#### 3.1 List of tables

Name	Comment
CONTRACTAGC	CONTRACTAGC shows Automatic Generation Control (AGC) contract details for each dispatchable unit. There is a separate contract for each unit.
CONTRACTLOADSHED	CONTRACTLOADSHED shows Governor contract details used in the settlement and dispatch of this service. Note: services are dispatched as 6 and 60 raise Frequency Control Ancillary Services (FCAS). Mandatory requirements and breakpoint details are not used for load shed.
CONTRACTREACTIVEPOWER	CONTRACTREACTIVEPOWER shows Reactive Power contract details used in the settlement and dispatch of this service.
CONTRACTRESTARTSERVICES	CONTRACTRESTARTSERVICES shows Restart Services contract details used in the settlement and dispatch of this service.
CONTRACTRESTARTUNITS	CONTRACTRESTARTUNITS shows Restart units provided under a system restart contract. A service can have multiple units.

#### 3.2 Diagram: Entities: Ancillary Services

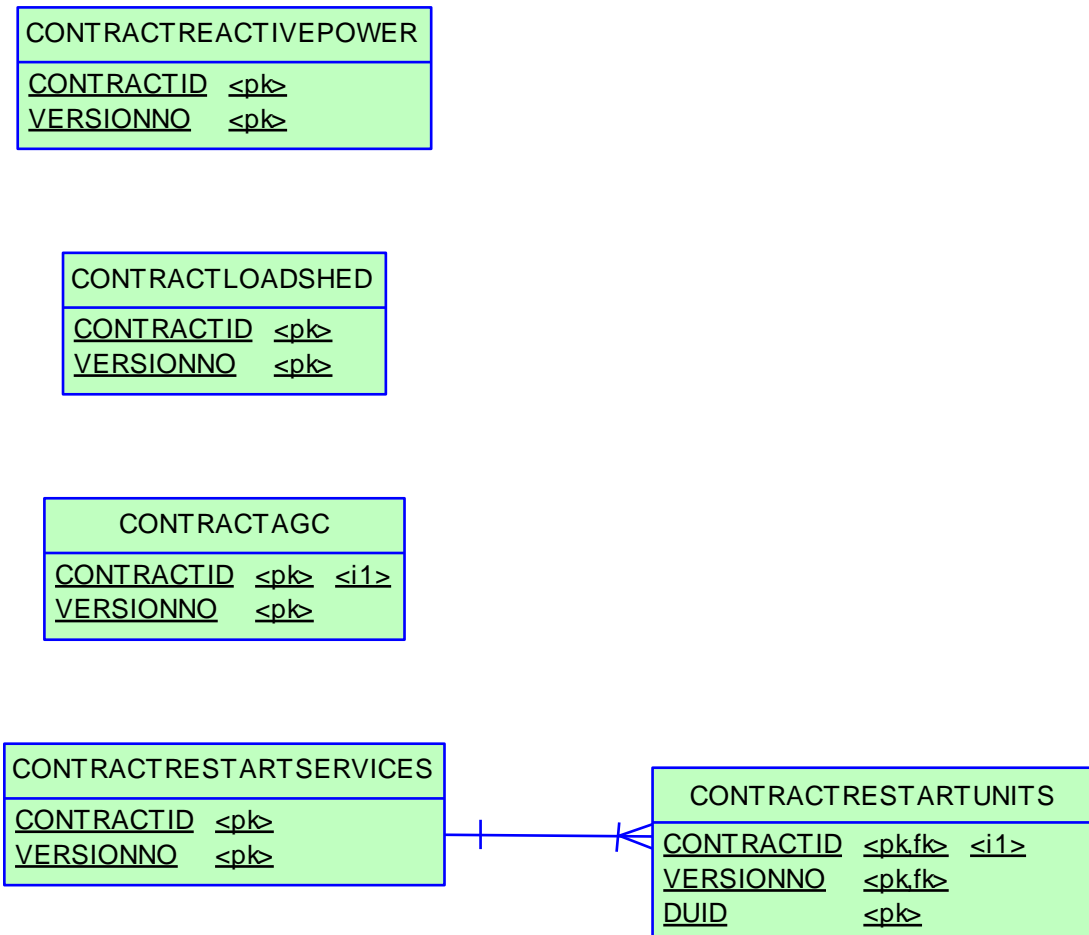

## 4 Package: ASOFFER

*Name* ASOFFER  
*Comment* Offer data for Ancillary Service Contracts

### 4.1 List of tables

Name	Comment
OFFERAGCDATA	OFFERAGCDATA shows availability reoffers of Automatic Generation Control.
OFFERASTRK	OFFERASTRK tracks successfully acknowledged ancillary service reoffers.
OFFERLSHEDDATA	OFFERLSHEDDATA shows reoffers of load shed including available load shed quantity.
OFFERRESTARTDATA	OFFERRESTARTDATA sets out reoffers of system restart availability.
OFFERRPOWERDATA	OFFERRPOWERDATA shows reoffers of reactive power capability and settlement measurements.

### 4.2 Diagram: Entities: Ancillary Service Contracts

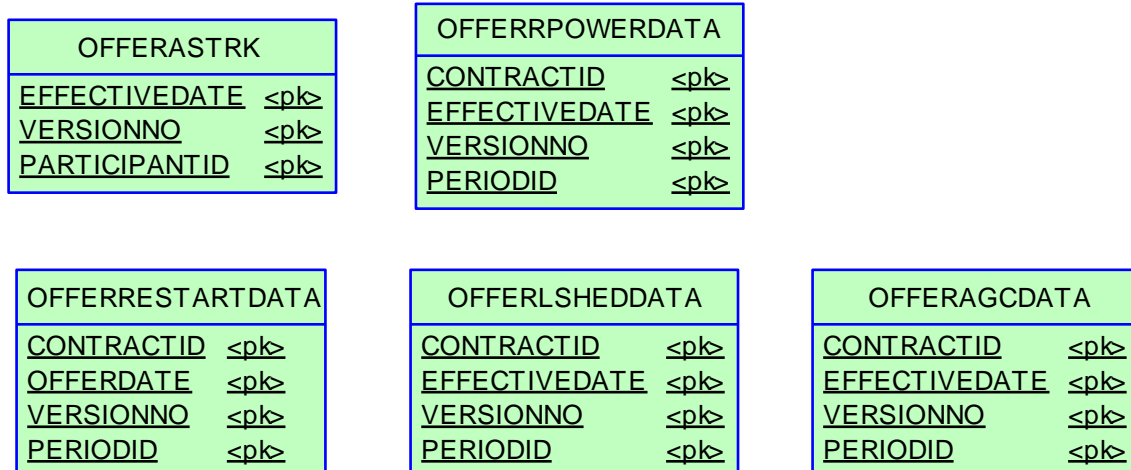

## 5 Package: BIDS

<i>Name</i>	BIDS
<i>Comment</i>	Energy and Market Based FCAS Offers

### 5.1 List of tables

Name	Comment
BIDDAYOFFER	BIDDAYOFFER shows the Energy and Ancillary Service bid data for each Market Day. BIDDAYOFFER is the parent table to BIDPEROFFER.
BIDDAYOFFER_D	BIDDAYOFFER_D shows the public summary of the energy and FCAS offers applicable in the Dispatch for the intervals identified. BIDDAYOFFER_D is the parent table to BIDPEROFFER_D.
BIDOFFERFILETRK	BIDOFFERFILETRK shows an audit trail of all files submitted containing an FCAS bid, including corrupt bids and rebids.
BIDPEROFFER	BIDPEROFFER shows period-based Energy and Ancillary Service bid data. BIDPEROFFER is a child table of BIDDAYOFFER.
BIDPEROFFER_D	BIDPEROFFER_D shows the public summary of the energy and FCAS offers applicable in the Dispatch for the intervals identified. BIDPEROFFER_D is the child to BIDDAYOFFER_D.
MNSP_DAYOFFER	MNSP_DAYOFFER shows price and other non-period data pertaining to a specific MNSP bid and Link ID to be effective from the given Settlement Date. MNSP_DAYOFFER is the parent table to MNSP_PEROFFER, and joins to MNSP_OFFERTRK.
MNSP_FILETRK	MNSP_FILETRK shows all MNSPOFFERS transmitted to the MMS system.
MNSP_OFFERTRK	MNSP_OFFERTRK records all valid MNSPOFFERS loaded into the MMS system. The authorised date reflects the date and time of the load. MNSP_OFFERTRK is key for tracking MNSP bid submission.
MNSP_PEROFFER	MNSP_PEROFFER shows period by period availability and other period data pertaining to a specific bid and LinkID for the given Settlement Date. MNSP_PEROFFER is a child to MNSP_DAYOFFER and links to MNSP_OFFERTRK.
MTPASA_OFFERDATA	Participant submitted Offers for MTPASA process
MTPASA_OFFERFILETRK	Participant submitted Offers for MTPASA process

## 5.2 Diagram: Entities: Bids

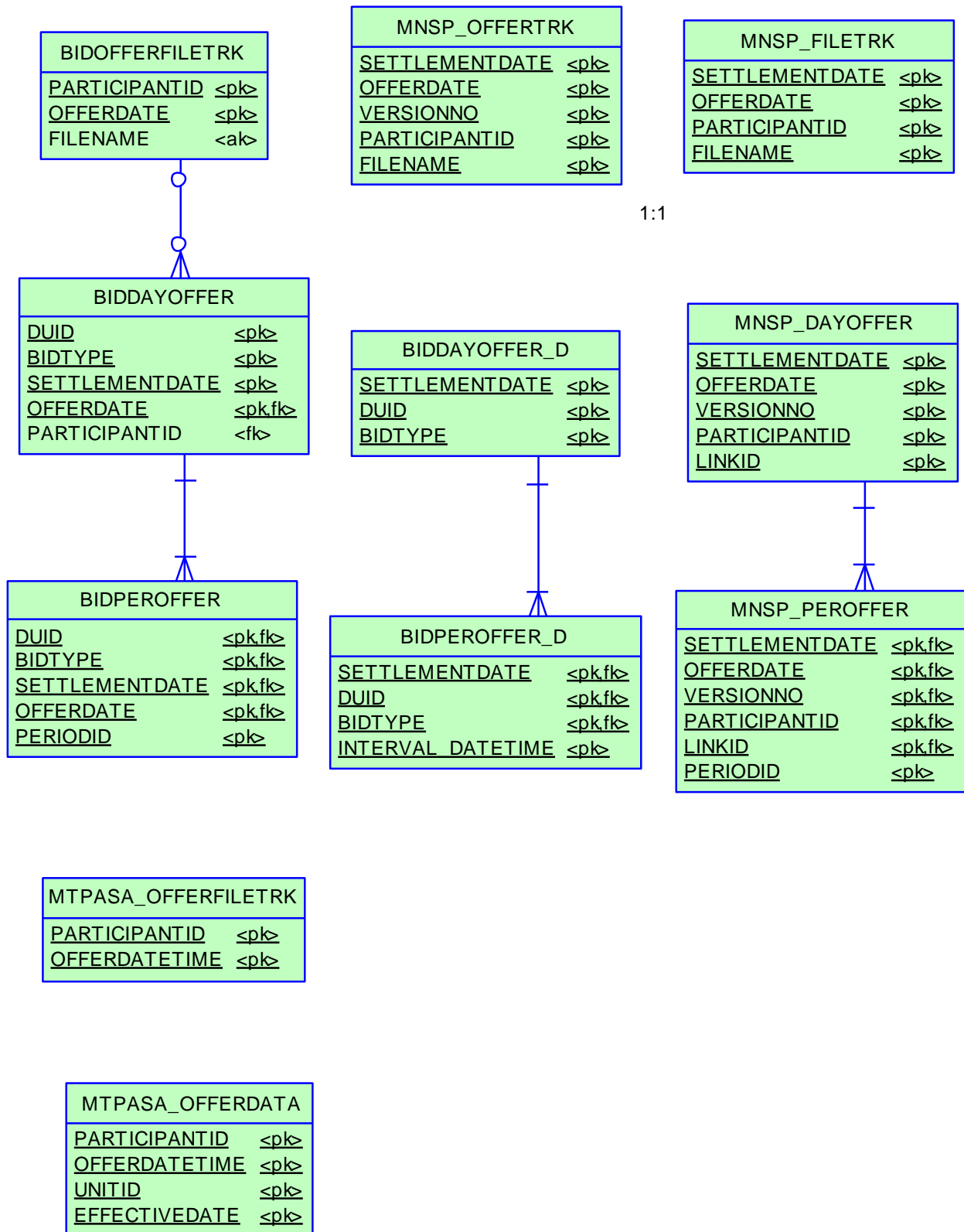

## 6 Package: BILLING\_CONFIG

<i>Name</i>	BILLING_CONFIG
<i>Comment</i>	Configuration data for the Billing Process

### 6.1 List of tables

Name	Comment
BILLINGCALENDAR	BILLINGCALENDAR sets out the billing calendar for the year, with week number 1 starting on 1 January. BILLINGCALENDAR advises preliminary and final statement posting date and corresponding settlement for each billing week.
GST_BAS_CLASS	GST_BAS_CLASS contains a static list of BAS (Business Activity Statement) classifications supported by the MMS.
GST_RATE	GST_RATE maintains the GST rates on a BAS (Business Activity Statement) class basis.
GST_TRANSACTION_CLASS	GST_TRANSACTION_CLASS maps NEM settlement transaction types with BAS (Business Activity Statement) classifications.
GST_TRANSACTION_TYPE	GST_TRANSACTION_TYPE shows a static list of transaction types supported by the MMS.
SECDEPOSIT_INTEREST_RATE	The security deposit interest rate on a daily basis. This is the public table published when the business enter and authorise a new daily interest rate
SECDEPOSIT_PROVISION	The security deposit provision entry details

## 6.2 Diagram: Entities: Billing Config

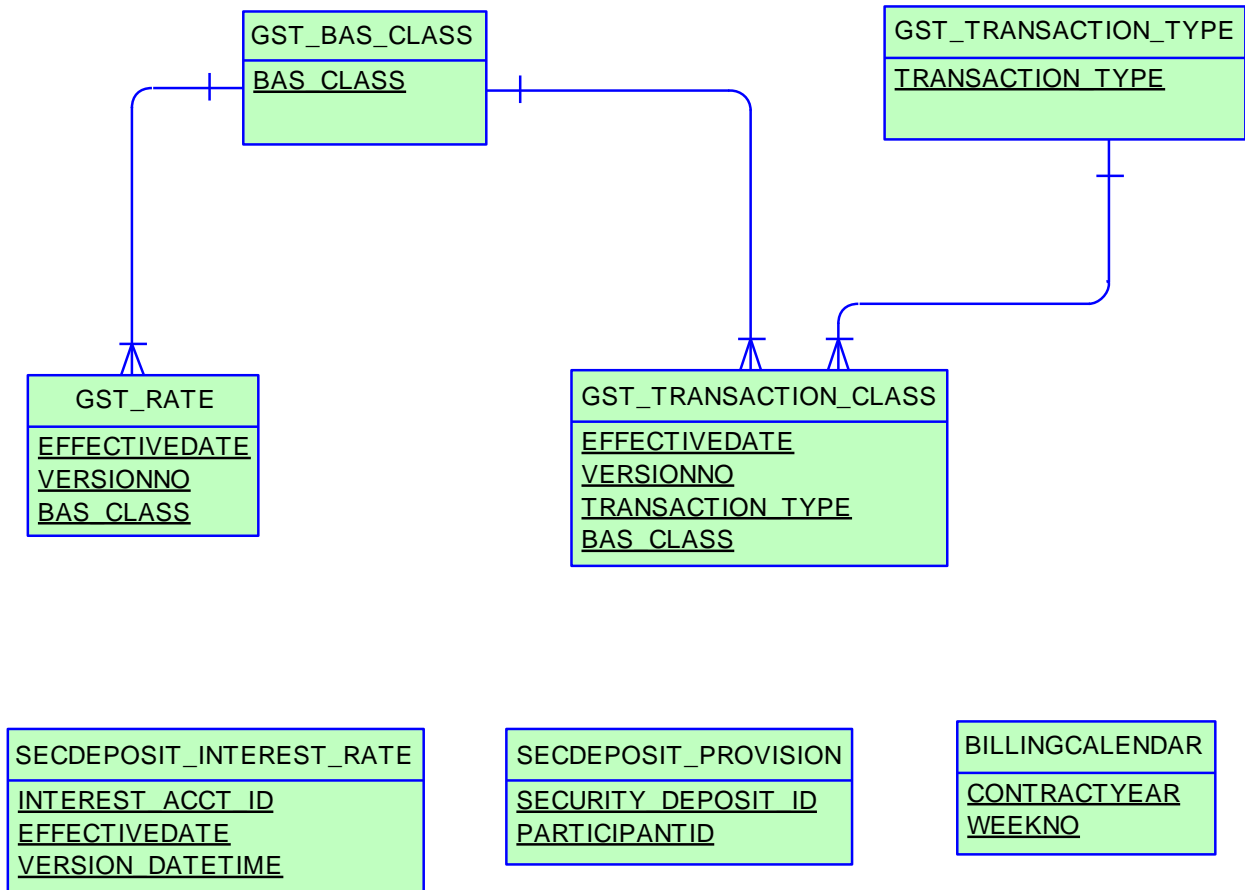

## 7 Package: BILLING\_RUN

<i>Name</i>	BILLING_RUN
<i>Comment</i>	Results from a published Billing Run. The settlement data and billing run data are updated daily between 6am and 8am for AEMO's prudential processes. In a normal week, AEMO publishes one PRELIM, one FINAL and two REVISION runs in addition to the daily runs.

Each billing run is uniquely identified by contract year, week no and bill run no.

### 7.1 List of tables

Name	Comment
BILLING_APC_COMPENSATION	Billing result table for APC compensation payments.
BILLING_APC_RECOVERY	Billing result table for recovery of APC compensation payments
BILLING_CO2E_PUBLICATION	Carbon Dioxide Intensity Index publication table
BILLING_CO2E_PUBLICATION_TRK	Carbon Dioxide Intensity Index publication tracking table
BILLING_DAILY_ENERGY_SUMMARY	Billing result table containing daily summary data for customer and generator energy amounts
BILLING_DIRECTION_RECON_OTHER	Billing reconciliation result table for both provisional and final directions
BILLING_DIRECTION_RECONCILIATION	Billing reconciliation result table for both provisional and final directions using the FPP methodology (prior to 1st July 2011)
BILLING_EFTSHORTFALL_AMOUNT	The billing shortfall run amounts
BILLING_EFTSHORTFALL_DETAIL	The Billing Shortfall Run Amount details
BILLING_GST_DETAIL	BILLING_GST_DETAIL shows the BAS class, GST_Exclusive and GST amount (if any) attributable to a participant for each transaction type.
BILLING_GST_SUMMARY	BILLING_GST_SUMMARY shows the GST_Exclusive and GST amount (if any) attributable to a participant for each BAS class.
BILLING_MR_PAYMENT	BILLING_MR_PAYMENT shows aggregate payments on a dispatchable unit/MR Event basis for accepted MR capacity
BILLING_MR_RECOVERY	BILLING_MR_RECOVERY shows aggregate recovery charges on a dispatchable unit / MR Event basis for spot market income from dispatch of MR capacity.
BILLING_MR_SHORTFALL	BILLING_MR_SHORTFALL shows aggregate MR shortfall payments (or recovery charges) to each participant in the region for the MR event.
BILLING_MR_SUMMARY	BILLING_MR_SUMMARY shows aggregate payment/recovery and shortfall figures for an MR Event.
BILLING_NMAS_TST_PAYMENTS	BILLING_NMAS_TEST_PAYMENTS publish the NSCAS/SRAS Testing Payments data for a posted billing week.
BILLING_NMAS_TST_RECOVERY	BILLING_NMAS_TEST_RECOVERY sets out the recovery of NMAS testing payments
BILLING_NMAS_TST_RECOVERY_RBF	BILLING_NMAS_TEST_RECOVERY_RBF sets out the NSCAS/SRAS Testing Payment recovery data for the posted billing week.
BILLING_NMAS_TST_RECOVERY_TRK	BILLING_NMAS_TEST_RECOVERY_TRK tracks the energy data used to allocate the test payment recovery over the recovery



	period.
BILLING_RES_TRADER_PAYMENT	Billing result table for reserve trader contract payments
BILLING_RES_TRADER_RECOVERY	Billing result table for reserve trader contract recovery
BILLING_SECDEP_INTEREST_PAY	The interest amount for security deposit calculated by billing, based on whether it is a fixed/floating rate
BILLING_SECDEP_INTEREST_RATE	The DAILY interest rates used by billing when calculating the interest amount
BILLING_SECDEPOSIT_APPLICATION	The security deposit application details
BILLINGAPCCOMPENSATION	BILLINGAPCCOMPENSATION shows Administered Price Cap (APC) compensation amounts for the billing period. Data is for each participant by region.
BILLINGAPCRECOVERY	BILLINGAPCRECOVERY shows the Administered Price Cap (APC) Recovery for the billing period. Data is for each participant by region.
BILLINGASPAYMENTS	BILLINGASPAYMENTS shows Ancillary Service payments for each billing period by each of the Ancillary Service types for each participant's connection points.
BILLINGASRECOVERY	BILLINGASRECOVERY shows participant charges for Ancillary Services for the billing period. This view shows the billing amounts for Ancillary Service Recovery.
BILLINGCPDATA	BILLINGCPDATA shows energy quantity and \$ value purchased per participant connection point.
BILLINGDAYTRK	BILLINGDAYTRK is key for matching settlement versions with billing runs. BILLINGDAYTRK displays the billrunnos per billing week, and the settlement version numbers per settlement day comprising the billrunno.
BILLINGFEES	BILLINGFEES presents pool fees applied to the statement, per billing run.
BILLINGFINANCIALADJUSTMENTS	BILLINGFINANCIALADJUSTMENTS contains any manual adjustments included in the billing run.
BILLINGGENDATA	BILLINGGENDATA shows the total energy sold and purchased per participant transmission connection point for a billing period.
BILLINGINTERRESIDUES	BILLINGINTERRESIDUES shows interregion residues payable to NSP.
BILLINGINTRARESIDUES	BILLINGINTRARESIDUES shows intra-region settlement residue details for each Transmission Network Service Provider participant by region.
BILLINGIRAUCSURPLUS	BILLINGIRAUCSURPLUS supports the Settlements Residue Auction, by showing the weekly billing Interconnector Residue (IR) payments as calculated for each bill run for Network Service Providers (NSPs) from the amount not auctioned.
BILLINGIRAUCSURPLUSSUM	BILLINGIRAUCSURPLUSSUM contains Auction fees and Settlements Residue Auction distribution that may arise from unpurchased auction units that accrue to Transmission Network Service Providers.
BILLINGIRFM	BILLINGIRFM shows billing amounts associated with Industrial Relations Forced Majeure events for each participant.
BILLINGIRNSPSURPLUS	BILLINGIRNSPSURPLUS supports the Settlements Residue Auction (SRA), by showing the weekly billing Interconnector Residue (IR) payments as calculated for each bill run for Transmission Network Service Providers (TNSP) from the amount paid by participants (i.e. derogated amounts).
BILLINGIRNSPSURPLUSSUM	BILLINGIRNSPSURPLUSSUM contains derogated payments made to TNSPs arising from the Settlements Residue Auction process.
BILLINGIRPARTSURPLUS	BILLINGIRPARTSURPLUS supports the Settlements Residue Auction, by showing the weekly billing SRA distribution to Auction

	participants by Contract Identifier.
BILLINGIRPARTSURPLUSSUM	BILLINGIRPARTSURPLUSSUM supports the Settlements Residue Auction, by showing the weekly billing SRA distribution and associated fees to Auction participants.
BILLINGPRIORADJUSTMENTS	BILLINGPRIORADJUSTMENTS sets out prior period adjustments and associated interest inserted in subsequent Final Statements arising from Revision Statement postings.
BILLINGREALLOC	BILLINGREALLOC shows reallocation contract values in each billing run, where participants have used reallocations.
BILLINGREALLOC_DETAIL	Billing Reallocation Data aggregated by REALLOCATIONID for each billing run over the billing week.
BILLINGREGIONEXPORTS	BILLINGREGIONEXPORTS sets out the region summary table of overall energy exported to and from each region for each billing run.
BILLINGREGIONFIGURES	BILLINGREGIONFIGURES sets out additional summary region details including ancillary service amounts for each billing run.
BILLINGREGIONIMPORTS	BILLINGREGIONIMPORTS sets out the region summary table of overall energy imported to and from each region for each billing run.
BILLINGRUNTRK	BILLINGRUNTRK identifies the Statement type (i.e. Status of PRELIM, FINAL, REVISE) and date of the BillRunNo posted, per WeekNo. This provides a further extension of tracking data from the BILLINGDAYTRK table.
BILLINGSMELTERREDUCTION	BILLINGSMELTERREDUCTION shows the smelter reduction payment (only applies to participants with Victorian customer connection points).
BILLWHITEHOLE	BILLWHITEHOLE shows white hole payments based on participant vs region demand.



## 8 Package: CONFIGURATION

*Name* CONFIGURATION

*Comment* MMS Data Model Configuration Management and Control

### 8.1 List of tables

Name	Comment
MMS_DATA_MODEL_AUDIT	MMS_DATA_MODEL_AUDIT shows the audit trail of scripts applied to this installation of MMS Data Model. Participants should ensure that if a database is cloned the content of this table is copied to the target database.

### 8.2 Diagram: Entities: Configuration

MMS_DATA_MODEL_AUDIT		
<u>INSTALLATION_DATE</u>	<u>DATE</u>	<pk>
<u>MMSDM_VERSION</u>	<u>VARCHAR2(20)</u>	<pk>
<u>INSTALL_TYPE</u>	<u>VARCHAR2(10)</u>	<pk>
SCRIPT_VERSION	VARCHAR2(20)	
NEM_CHANGE_NOTICE	VARCHAR2(20)	
PROJECT_TITLE	VARCHAR2(200)	
USERNAME	VARCHAR2(40)	
STATUS	VARCHAR2(10)	

## 9 Package: DEMAND\_FORECASTS

<i>Name</i>	DEMAND_FORECASTS
<i>Comment</i>	Regional Demand Forecasts and Intermittent Generation forecasts.

### 9.1 List of tables

Name	Comment
DEMANDOPERATIONALACTUAL	Shows Actual Operational Demand for a particular date time interval.
DEMANDOPERATIONALFORECAST	Shows Forecast Operational Demand for a particular date time interval.
INTERMITTENT_GEN_FCST	Identifying record for a given forecast of an intermittent generation. This table is the version table for the INTERMITTENT_GEN_FCST_DATA table which stores the individual forecast values
INTERMITTENT_GEN_FCST_DATA	Stores the forecast generation (MW) for each interval within a given forecast of an intermittent generator.
PERDEMAND	PERDEMAND sets out the regional demands and MR schedule data for each half-hour period. PERDEMAND is a child table to RESDEMANDTRK.
RESDEMANDTRK	RESDEMANDTRK defines the existence and versioning information of a forecast for a specific region and trading date. RESDEMANDTRK and PERDEMAND have a parent/child relationship, and are for defined forecast regional demands since market start. RESDEMANDTRK defines the existence and versioning information of a forecast for a specific region and trading date. PERDEMAND defines the numerical forecast values for each trading interval of a the trading day for that region. A complete trading day forecast for one region consists of one RESDEMANDTRK record and 48 PERDEMAND records.
ROOFTOP_PV_ACTUAL	Estimate of regional Rooftop Solar actual generation for each half-hour interval in a day
ROOFTOP_PV_FORECAST	Regional forecasts of Rooftop Solar generation across the half-hour intervals over 8 days

## 9.2 Diagram: Entities: Demand Forecasts

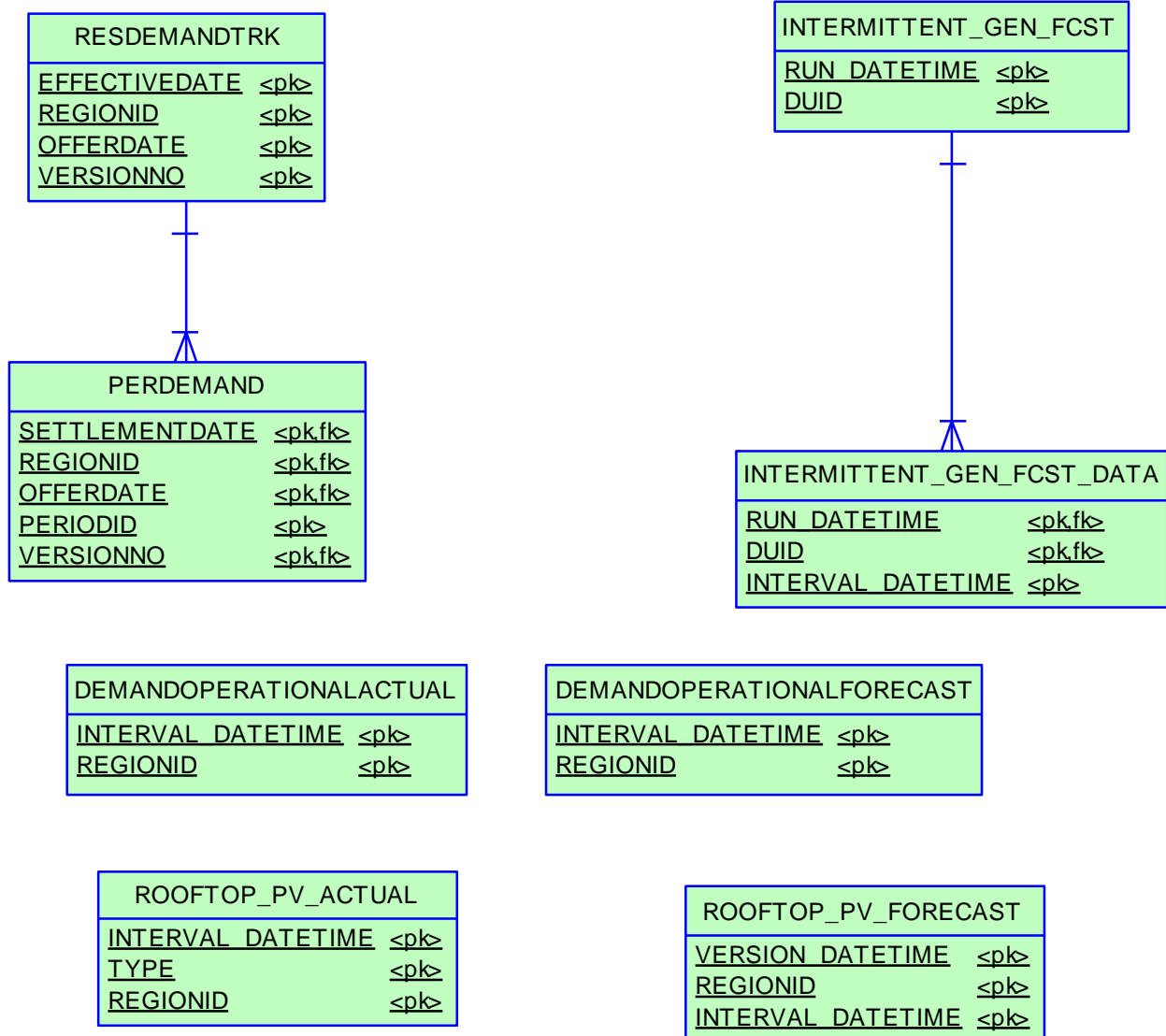

## 10 Package: DISPATCH

<i>Name</i>	DISPATCH
<i>Comment</i>	Results from a published Dispatch Run

### 10.1 List of tables

Name	Comment
CONSTRAINTRELAXATION_OCD	CONSTRAINTRELAXATION_OCD contains details of interconnector constraints and unit ancillary service constraints relaxed in the over-constrained dispatch (OCD) re-run for this interval (if there was one). Note: INTERVENTION is not included in CONSTRAINTRELAXATION_OCD, since the relaxation of the same constraint is the same amount in both intervened and non-intervened cases.
DISPATCH_CONSTRAINT_FCAS_OCD	FCAS constraint solution from OCD re-run.
DISPATCH_FCAS_REQ	DISPATCH_FCAS_REQ shows Dispatch Constraint tracking for Regional FCAS recovery.
DISPATCH_INTERCONNECTION	Inter-regional flow information common to or aggregated for regulated (i.e. not MNSP) Interconnectors spanning the From-Region and To-Region - NB only the physical run is calculated'
DISPATCH_LOCAL_PRICE	Sets out local pricing offsets associated with each DUID connection point for each dispatch period. Note that from 2014 Mid year release only records with non-zero Local_Price_Adjustment values are issued
DISPATCH_MNSPBIDTRK	DISPATCH_MNSPBIDTRK shows the MNSP bid tracking, including the bid version used in each dispatch run for each MNSP Interconnector Link. DISPATCH_MNSPBIDTRK is the audit trail of the bids actually used for each dispatch run.
DISPATCH_MR_SCHEDULE_TRK	DISPATCH_MR_SCHEDULE_TRK records the Mandatory Restrictions Acceptance Schedule applied to this dispatch interval for this region. DISPATCH_MR_SCHEDULE_TRK is populated by the Dispatch process and records the MR Offer Stack applied in each dispatch interval. DISPATCH_MR_SCHEDULE_TRK is used by Settlements to calculate payments according to the correct MR offer stack.
DISPATCH_PRICE_REVISION	An audit trail of price changes on the DISPATCHPRICE table (i.e. for 5 minute dispatch prices for energy and FCAS).
DISPATCH_UNIT_CONFORMANCE	DISPATCH_UNIT_CONFORMANCE details the conformance of a scheduled units operation with respect to a cleared target on dispatch interval basis. Data is confidential
DISPATCH_UNIT_SCADA	Dispatchable unit MW from SCADA at the start of the dispatch interval. The table includes all scheduled and semi-scheduled (and non-scheduled units where SCADA is available)
DISPATCHBLOCKEDCONSTRAINT	DISPATCH Blocked Constraints lists any constraints that were blocked in a dispatch run. If no constraints are blocked, there will be no rows for that dispatch run.
DISPATCHCASESOLUTION	DISPATCHCASESOLUTION shows information relating to the complete dispatch run. The fields in DISPATCHCASESOLUTION provide an overview of the dispatch run results allowing immediate

	identification of conditions such as energy or FCAS deficiencies.
DISPATCHCONSTRAINT	DISPATCHCONSTRAINT sets out details of all binding and interregion constraints in each dispatch run. Note: invoked constraints can be established from GENCONSETINVOKE. Binding constraints show as marginal value >\$0. Interconnector constraints are listed so RHS (SCADA calculated limits) can be reported.
DISPATCHINTERCONNECTORRES	DISPATCHINTERCONNECTORRES sets out MW flow and losses on each interconnector for each dispatch period, including fields for the Frequency Controlled Ancillary Services export and import limits and extra reporting of the generic constraints set the energy import and export limits.
DISPATCHLOAD	DISPATCHLOAD set out the current SCADA MW and target MW for each dispatchable unit, including relevant Frequency Control Ancillary Services (FCAS) enabling targets for each five minutes and additional fields to handle the new Ancillary Services functionality. Fast Start Plant status is indicated by dispatch mode.
DISPATCHOFFERTRK	DISPATCHOFFERTRK is the energy and ancillary service bid tracking table for the Dispatch process. The table identifies which bids from BIDDAYOFFER and BIDPEROFFER were applied for a given unit and bid type for each dispatch interval.
DISPATCHPRICE	DISPATCHPRICE records 5 minute dispatch prices for energy and FCAS, including whether an intervention has occurred, or price override (e.g. for Administered Price Cap). DISPATCHPRICE updates when price adjustments occur, in which case the new price is written to the RRP field, and the old price to the ROP field as an audit trail.
DISPATCHREGIONSUM	DISPATCHREGIONSUM sets out the 5-minute solution for each dispatch run for each region, including the Frequency Control Ancillary Services (FCAS) services provided. Additional fields are for the Raise Regulation and Lower Regulation Ancillary Services plus improvements to demand calculations.
NEGATIVE_RESIDUE	Shows the inputs provided to the Negative Residue Constraints in the Dispatch horizon



## 10.2 Diagram: Entities: Dispatch

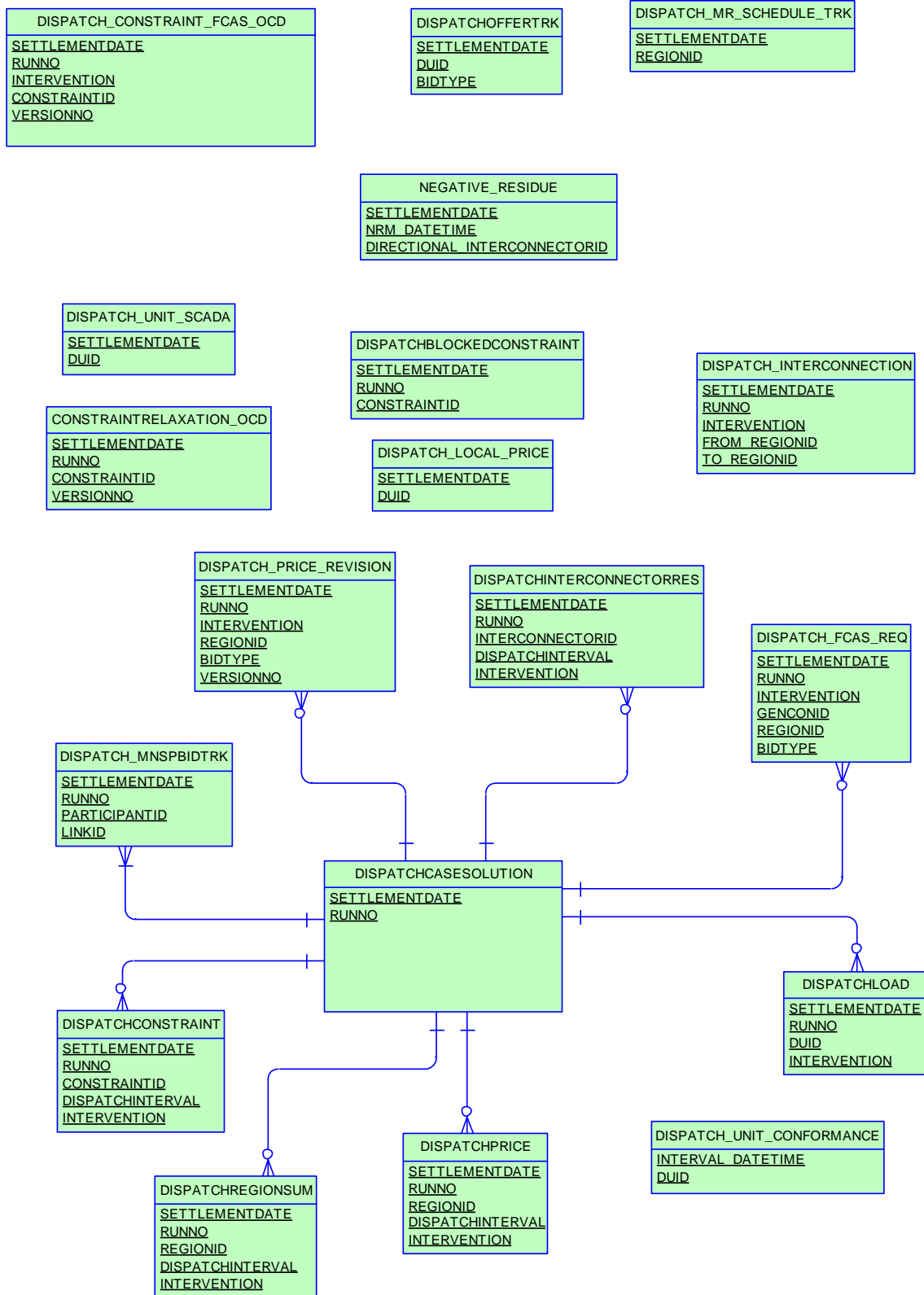

## 11 Package: FORCE\_MAJEURE

<i>Name</i>	FORCE_MAJEURE
<i>Comment</i>	Market Suspensions and administer pricing event data

### 11.1 List of tables

Name	Comment
APEVENT	APEVENT is the driving data defining the existence and timeframes of an administered pricing event.
APEVENTREGION	APEVENTREGION is the Region detail for an administered pricing event defined through APEVENT.
IRFMAMOUNT	IRFMAMOUNT sets out settlement amounts associated with Industrial Relations Forced Majeure events.
IRFMEVENTS	IRFMEVENTS sets out specific Industrial Relations Forced Majeure events.
MARKET_SUSPEND_REGIME_SUM	Tracks the evolution of pricing regimes applied to the suspended region and from which Dispatch Interval
MARKET_SUSPEND_REGION_SUM	Summary of Market Suspension timings
MARKET_SUSPEND_SCHEDULE	Trading prices that will apply in the event of a market suspension event updated weekly.
MARKET_SUSPEND_SCHEDULE_TRK	Parent table for pricing regimes used in suspensions
OVERRIDE_RRP	OVERRIDE_RRP shows details of override price periods.
REGIONAPC	REGIONAPC defines Administered Price profiles (Energy and FCAS) for a region.
REGIONAPCINTERVALS	REGIONAPCINTERVALS contains Administered Price profiles (Energy and FCAS) applicable to each interval for a region.

## 11.2 Diagram: Entities: Force Majeure

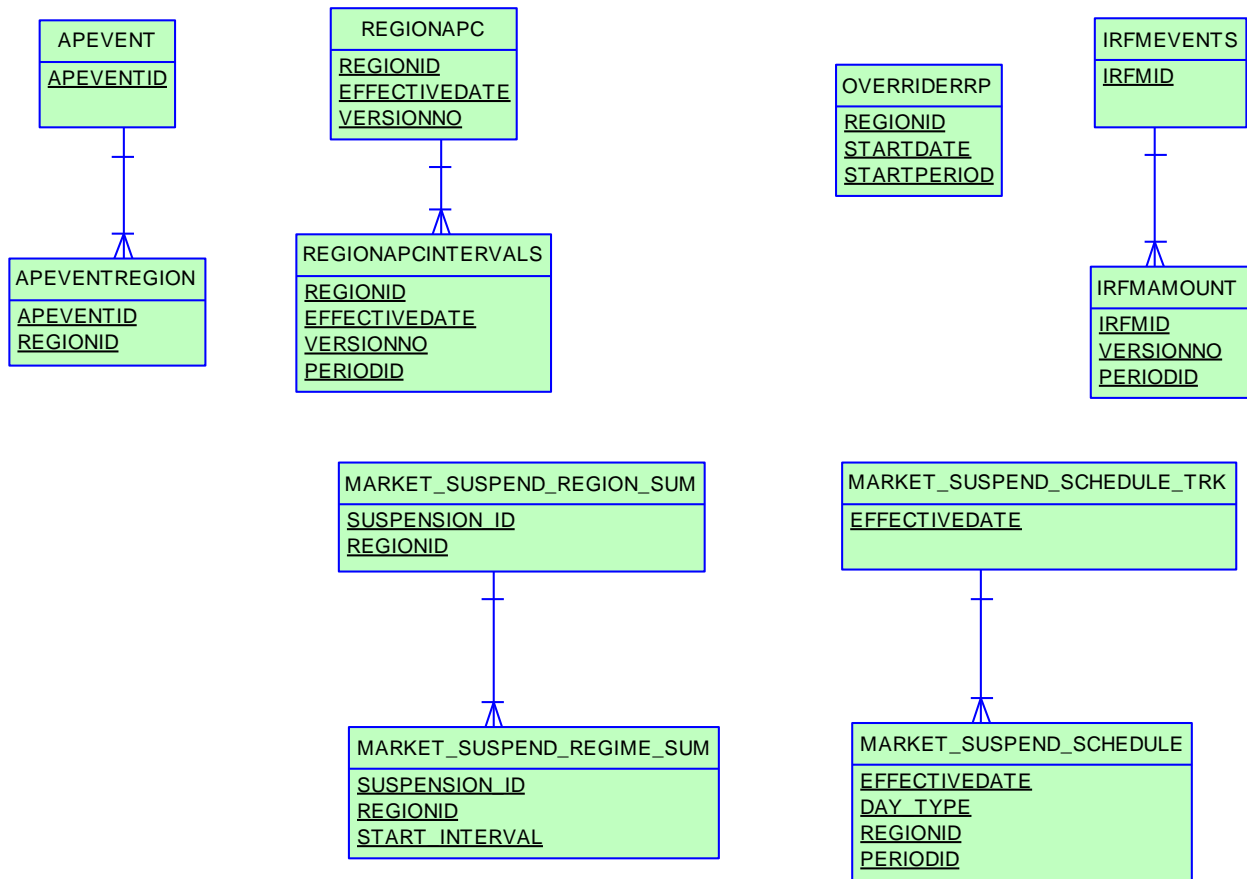

## 12 Package: GD\_INSTRUCT

*Name* GD\_INSTRUCT  
*Comment* General Dispatch Instruction data

### 12.1 List of tables

Name	Comment
GDINSTRUCT	GDINSTRUCT shows all manually issued dispatch instructions for a dispatchable unit. Ancillary Service instructions are to enable and to disable (i.e. 2 separate instructions) a service. Non-conforming units are also instructed via this facility. However, this facility is not the same as the market notice.
INSTRUCTIONSUBTYPE	Each Dispatch instruction (GD instruct) has a type and subtype. INSTRUCTIONSUBTYPE, together with INSTRUCTIONTYPE, sets out valid instruction types.
INSTRUCTIONTYPE	Dispatch instruction (GD instruct) has types and subtypes. INSTRUCTIONTYPE, together with INSTRUCTIONSUBTYPE, sets out valid instruction types.

### 12.2 Diagram: Entities: GD Instruct

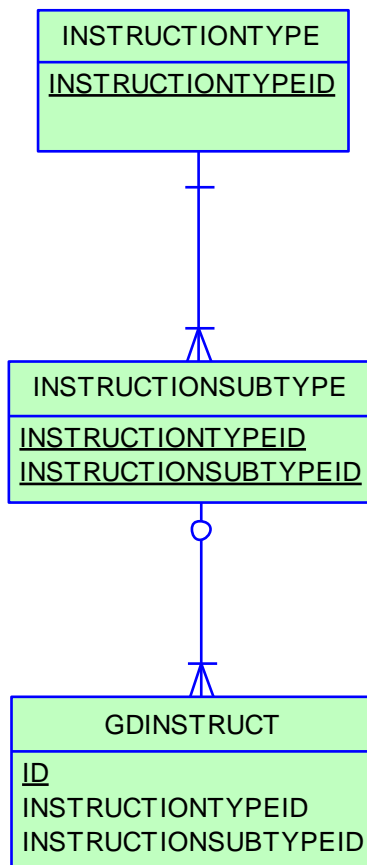

## 13 Package: GENERIC\_CONSTRAINT

<i>Name</i>	GENERIC_CONSTRAINT
<i>Comment</i>	Generic Constraint Standing Data and Invocations

### 13.1 List of tables

Name	Comment
EMSMASTER	EMSMASTER provides a description of the SCADA measurements that are associated with the SPD_ID points utilised in generic equation RHS terms
GENCONDATA	GENCONDATA sets out the generic constraints contained within a generic constraint set invoked in PASA, predispach and dispatch. Fields enable selective application of invoked constraints in the Dispatch, Predispach, ST PASA or MT PASA processes.
GENCONSET	GENCONSET sets out generic constraint sets that are invoked and revoked, and may contain many generic constraints (GENCONDATA).
GENCONSETINVOKE	GENCONSETINVOKE provides details of invoked and revoked generic constraints. GENCONSETINVOKE is the key table for determining what constraints are active in dispatch, predispach and PASA. GENCONSETINVOKE also indicates whether constraints are for interconnector limits, ancillary services, etc.
GENCONSETTRK	GENCONSETTRK assists in determining the correct version of a generic constraint set that has been invoked in GENCONSETINVOKE.
GENERICCONSTRAINTRHS	GENERICCONSTRAINTRHS sets out details of generic constraint Right Hand Side (RHS) formulations for dispatch (DS), predispach (PD) and Short Term PASA (ST). GENERICCONSTRAINTRHS also includes general expressions (EQ) used in the dispatch, predispach and PASA time frames. GENERICCONSTRAINTRHS replaces data previously available via the "Constraint Library" Excel spreadsheet.
GENERICEQUATIONDESC	GENERICEQUATIONDESC defines a generic equation identifier with a description. The formulation of the generic equation is detailed in GENERICEQUATIONRHS.
GENERICEQUATIONRHS	GENERICEQUATIONRHS stores the formulation of commonly used Generic Constraint Right Hand Side Equations referenced from Generic Constraint Right Hand Side definitions stored in GENERICCONSTRAINTRHS. The Generic Equation definitions are versioned and the latest effective version is applied to the dispatch process.
SPDCONNECTIONPOINTCONSTRAINT	SPDCONNECTIONPOINTCONSTRAINT sets out details of connections point constraints issued in dispatch, predispach and STPASA.
SPDINTERCONNECTORCONSTRAINT	SPDINTERCONNECTORCONSTRAINT contains details on the interconnector constraint factors used in dispatch, predispach and STPASA. The details set a LHS value.
SPDREGIONCONSTRAINT	SPDREGIONCONSTRAINT contains details on region demand constraint factors used in dispatch. SPDREGIONCONSTRAINT sets a LHS value.

### 13.2 Diagram: Entities: Generic Constraints

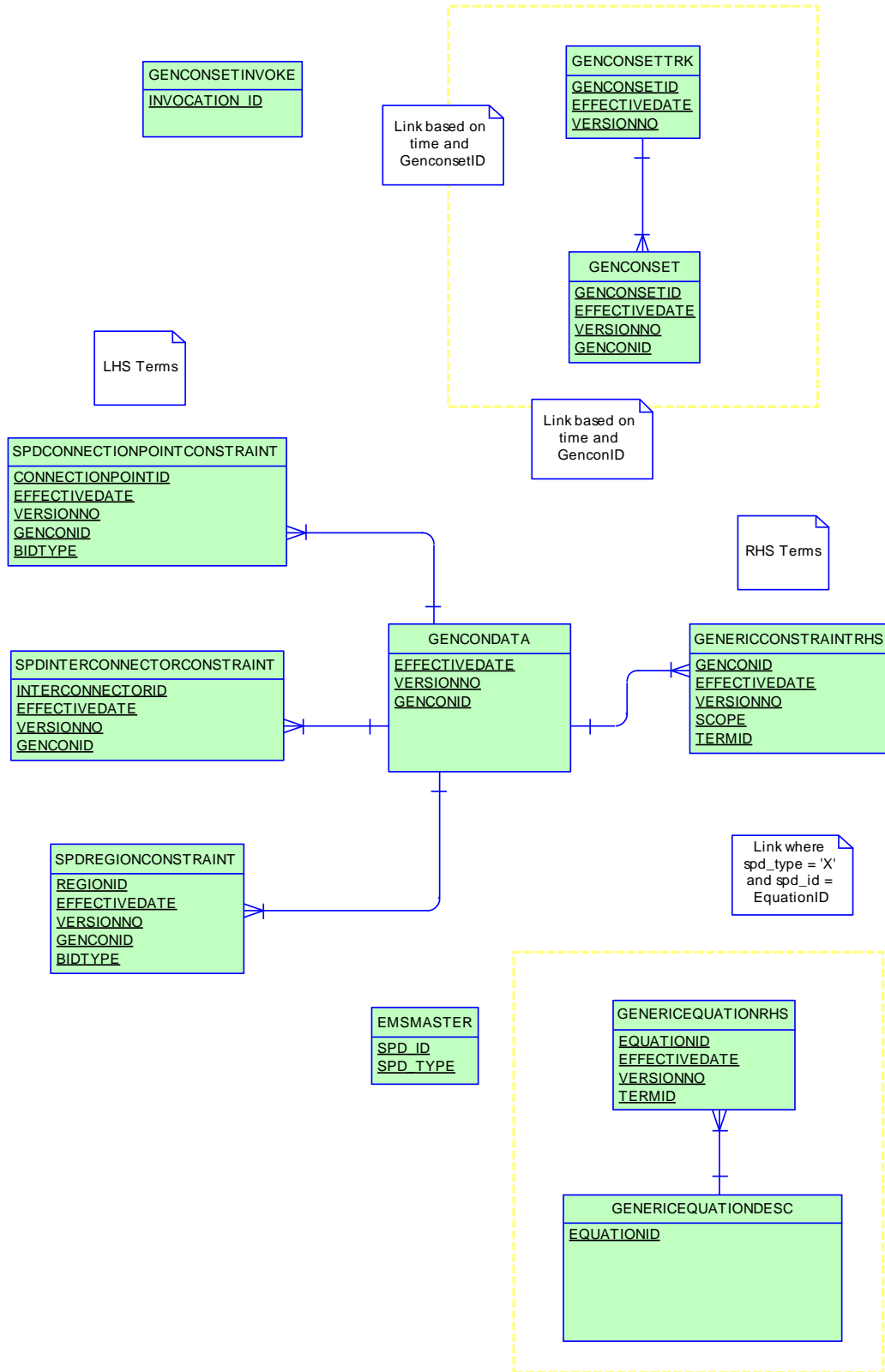

## 14 Package: HISTORICAL TABLES

<i>Name</i>	HISTORICAL TABLES
<i>Comment</i>	These tables are no longer used

### 14.1 List of tables

Name	Comment
APCCOMP	APCCOMP is to set out Administered Price Cap (APC) compensation periods for a participant.
APCCOMPAMOUNT	APCCOMPAMOUNT shows the Administered Price Cap (APC) compensation amount.
APCCOMPAMOUNTTRK	APCCOMPAMOUNTTRK sets out the relevant Administered Price Cap (APC) period for compensation purposes. Use the APCCOMPAMOUNTTRK table in conjunction with APCAMOUNT.
BILLADJUSTMENTS	
BILLING_CSP_DEROGATION_AMOUNT	CSP derogation amounts with respect to participant allocated payment
BILLINGCPSUM	BILLINGCPSUM shows adjustments for a billing run by participant.
BILLINGCUSTEXCESSGEN	BILLINGCUSTEXCESSGEN shows excess generation payments for each participant cutover.
BILLINGEXCESSGEN	BILLINGEXCESSGEN shows the excess generation cost by period for each participant.
BILLINGINTERVENTION	BILLINGINTERVENTION shows billing intervention recovery details.
BILLINGINTERVENTIONREGION	BILLINGINTERVENTIONREGION shows recovery charges for region intervention.
BILLINGRESERVERECOVERY	BILLINGRESERVERECOVERY shows Market Reserve recovery details for each participant in a bill run.
BILLINGRESERVEREGIONRECOVERY	BILLINGRESERVEREGIONRECOVERY shows Billing Region Reserve region recovery details for each participant (by region).
BILLINGRESERVETRADER	BILLINGRESERVETRADER shows Billing Market Reserve TRADER payment details to Generators.
BILLINGRESERVETRADERREGION	BILLINGRESERVETRADERREGION shows Billing Region Reserve Trader payment details.
BILLINTERVENTIONRECOVERY	BILLINTERVENTIONRECOVERY shows billing market intervention recovery details for each participant.
BILLINTERVENTIONREGIONRECOVERY	BILLINTERVENTIONREGIONRECOVERY shows billing region intervention recovery details for each participant by region.
BILLSMELTERRATE	BILLSMELTERRATE is standing data, setting out the rates used in smelter reduction calculations.
CONNECTIONPOINT	CONNECTIONPOINT shows all valid connection points and their type. Transmission loss factors are available for all connection points in TRANSMISSIONLOSSFACTOR.
CONNECTIONPOINTDETAILS	CONNECTIONPOINTDETAILS is obsolete, since it was never populated by Participants accessing AEMO's Oracle Interface. CONNECTIONPOINTDETAILS was designed to show relevant details for each connection point including the responsible party, loss factor and relevant MDAs.
CONNECTIONPOINTOPERATINGSTA	CONNECTIONPOINTOPERATINGSTA shows whether a connection point is active or not.
CONTRACTGOVERNOR	CONTRACTGOVERNOR became unused when Ancillary Services Review was implemented in 2001. For more details, see Change Notice 126. CONTRACTGOVERNOR shows Governor contract details used in

	the settlement and dispatch of this service. Note services are dispatched as 6 and 60 raise and lower Frequency Control Ancillary Services (FCAS). Lower and raise 6 and 60 second fields are used in dispatch of services. Deadband and Droop details are used in settlements.
CONTRACTRESERVEFLAG	CONTRACTRESERVEFLAG has never been or will be used. It was to show a period by period flag for regional or market recovery of reserve trading contract amounts.
CONTRACTRESERVETHRESHOLD	CONTRACTRESERVETHRESHOLD shows reserve contract threshold details for enabling, usage and availability thresholds and rates for reserve trader contracts.
CONTRACTRESERVETRADER	CONTRACTRESERVETRADER shows reserve trader contract details. Version numbers do not apply as contracts exist for specified purposes.
CONTRACTUNITLOADING	CONTRACTUNITLOADING became unused when Ancillary Services Review was implemented in 2001. For more details, see Change Notice 126. CONTRACTUNITLOADING shows Unit Loading contract details used in the settlement and dispatch of this service.
CONTRACTUNITUNLOADING	CONTRACTUNITUNLOADING shows Ancillary Service contract data for rapid generator unit unloading.
DAYOFFER	DAYOFFER sets out the participants' daily components of participant bid containing details applying for the whole day (such as prices, daily energy constraint and fast start profiles). To retrieve full bid details, read in conjunction with PEROFFER.
DAYOFFER_D	DAYOFFER_D sets out the participants' daily components of participant bid containing just the latest details (such as prices, daily energy constraint and fast start profiles). To retrieve latest bid details, read in conjunction with PEROFFER_D.
DEFAULTDAYOFFER	DEFAULTDAYOFFER shows day-based details of participants' default bids unit for the same day.
DEFAULTOFFERTRK	DEFAULTOFFERTRK shows the file names of default offers submitted for each unit.
DEFAULTPEROFFER	DEFAULTPEROFFER shows half hourly period-based data in the default bid for each Dispatchable Unit, such as period availability, rate of change and band quantities.
DELTAMW	DELTAMW sets out the Frequency Control Ancillary Services (FCAS) requirement to be provided locally within each region and each half-hour period in a market day. Two fields specify Frequency Controlled Ancillary Services requirements to be provided locally for the new regulation ancillary services.
DISPATCHBIDTRK	DISPATCHBIDTRK shows the bid tracking, including the bid version used in each dispatch run for each unit. DISPATCHBIDTRK is the audit trail of the bid actually used in each dispatch.
DISPATCHCASE_OCD	DISPATCHCASE_OCD shows the key data to indicate when an over-constrained dispatch (OCD) re-run actually occurred. One record per over-constrained dispatch interval.
DISPATCHCASESOLUTION_BNC	DISPATCHCASESOLUTION_BNC was discontinued on 30 September 2009. Prior: DISPATCHCASESOLUTION_BNC is the key data to indicate when a binding intra-regional network constraints (BNC) re-run actually occurred.
DISPATCHLOAD_BNC	DISPATCHLOAD_BNC was discontinued on 30 September 2009. Prior: DISPATCHLOAD_BNC gives binding intra-regional network constraints (BNC) re-run dispatch results for all scheduled generating units. DISPATCHLOAD_BNC has a similar structure to DISPATCHLOAD but does not repeat input type data (e.g. InitialMW, AGCStatus) since these values are available from DISPATCHLOAD.



DISPATCHTRK	DISPATCHTRK is no longer used. DISPATCHTRK was the cross-reference between each dispatch run and SPD case run. DISPATCHTRK may be available on the InfoServer but not replicated to participant databases as it contains data duplicated in other tables.
FORCEMAJEURE	FORCEMAJEURE used to set out the start and end dates / periods of any force majeure event. FORCEMAJEURE is not used.
FORCEMAJEUREREGION	FORCEMAJEUREREGION used to set out regions impacted by a force majeure event. This table is not used.
GENUNITMTRINPERIOD	GENUNITMTRINPERIOD shows meter reading by period for each generator meter. GENUNITMTRINPERIOD covers generated power flowing into the system. It is used to calculate settlement values.
INTCONTRACT	INTCONTRACT shows intervention contract details. These are specific to each intervention.
INTCONTRACTAMOUNT	INTCONTRACTAMOUNT shows intervention contract amounts.
INTCONTRACTAMOUNTTRK	INTCONTRACTAMOUNTTRK shows the latest valid version of each intervention contract.
INTERCONNMMWFLOW	INTERCONNMMWFLOW shows Metered Interconnector flow data. INTERCONNMMWFLOW shows the meter data provided by Meter Data Providers to MSATS. Despite the name, this view shows metered energy (MWh) and not power flow (MW).
MARKETSUSPENSION	MARKETSUSPENSION is obsolete from 2017 End of Year DM4.27 Release. MARKETSUSPENSION sets out a start and end periods of any market suspension and the reason.
MARKETSUSREGION	MARKETSUSREGION is obsolete from 2017 End of Year DM4.27 Release. MARKETSUSREGION sets out a regions affected by a market suspension.
MAS_CP_CHANGE	MAS_CP_CHANGE records pending changes to the current MAS configuration.
MAS_CP_MASTER	MAS_CP_MASTER shows the current MAS configuration.
METERDATA	METERDATA sets out a meter data for each customer connection point. METERDATA covers market load. Use the field METERRUNNO to match the meter data version for each settlement run.
METERDATA_GEN_DUID	Recorded actual generation of non-scheduled units where SCADA data is available.
METERDATATRK	METERDATATRK records meter data files submitted for each connection point on a daily basis. The same data is provided in METERDATA period by period (i.e. 48 records), whereas METERDATATRK shows one record per day for each file submitted for a connection point.
MTPASA_CASE_SET	MTPASA_CASE_SET is obsolete from 2005 End of Year Release. The RUNTYPE added to the primary key of the detail tables for MTPASA allows for the different types of runs for each case. MTPASA_CASE_SET allows a MT PASA scenario to be linked across runs.
MTPASA_CASESOLUTION	MTPASA_CASESOLUTION is obsolete from 2017 End of Year DM4.27 Release.  MTPASA_CASESOLUTION holds one record for each entire solution. Change Notice 379 announced the replacement of the MT PASA data model so all MTPASAxix tables become obsolete, replaced by MTPASA_xxx tables.

MTPASA_CONSTRAINTSOLUTION	<p>MTPASA_CONSTRAINTSOLUTION is obsolete from 2017 End of Year DM4.27 Release.</p> <p>The MTPASA_CONSTRAINTSOLUTION table holds the binding and violated constraint results from the capacity evaluation, including the RHS value.</p> <p>Change Notice 379 announced the replacement of the MT PASA data model so all MTPASAxXX tables become obsolete, replaced by MTPASA_XXX tables.</p>
MTPASA_INTERCONNECTORSOLUTION	<p>MTPASA_INTERCONNECTORSOLUTION is obsolete from 2017 End of Year DM4.27 Release.</p> <p>The MTPASA_INTERCONNECTORSOLUTION table shows the results of the capacity evaluation for Interconnectors, including the calculated limits for the Idcblock within the day.</p> <p>Change Notice 379 announced the replacement of the MT PASA data model so all MTPASAxXX tables become obsolete, replaced by MTPASA_XXX tables (see Change Notices 400, 400a and 400b).</p>
MTPASA_REGIONSOLUTION	<p>MTPASA_CASESOLUTION is obsolete from 2017 End of Year DM4.27 Release.</p> <p>The MTPASA_REGIONSOLUTION table shows the results of the regional capacity, maximum surplus reserve and maximum spare capacity evaluations for each day and Idcblock of the study.</p>
MTPASA_RESERVELIMITSOLUTION	<p>MTPASA_RESERVELIMITSOLUTION is obsolete from 2017 End of Year DM4.27 Release.</p> <p>MT PASA Solution table reporting whether a MT PASA Reserve requirement is binding for each day and LDC block of the run.</p>
MTPASACONSTRAINTSOLUTION_D	MTPASACONSTRAINTSOLUTION_D sets out MT PASA constraint solution results, where constraints are binding.
MTPASAINTERCONNECTORSOLUTION_D	MTPASAINTERCONNECTORSOLUTION_D shows interconnector results for MT PASA, shown region by region.
MTPASAREGIONSOLUTION_D	MTPASAREGIONSOLUTION_D shows region results for MT PASA, showing predicted demand and any capacity limits.
OARTRACK	OARTRACK shows an audit trail of bids for a particular settlement day. Corrupt bids do not update OARTRACK, but are just in OFFERFILETRK.
OFFERFILETRK	OFFERFILETRK shows an audit trail of all bid files submitted containing energy bids, including corrupt bids/rebids.
OFFERGOVDATA	OFFERGOVDATA sets out reoffers of governor (6 and 60 second FCAS) availability.
OFFERUNLOADINGDATA	OFFERUNLOADINGDATA shows reoffers of rapid unit loading capability.
OFFERUNLOADINGDATA	OFFERUNLOADINGDATA shows reoffers of rapid unit unloading capability.
PASACASESOLUTION	PASACASESOLUTION sets out ST PASA case listing providing details of each STPASA case run.
PASACONSTRAINTSOLUTION	PASACONSTRAINTSOLUTION records the latest binding STPASA constraint details for each period. For each solution, the latest recalculation for each period overwrites the previous entry.
PASAINTERCONNECTORSOLUTION	PASAINTERCONNECTORSOLUTION records ST PASA interconnector solutions for the latest period.
PASAREGIONSOLUTION	PASAREGIONSOLUTION shows the Regional solution for ST PASA showing reserves for each half-hour period. This table (PASAREGIONSOLUTION_D) shows the latest calculated result

	for each period.
PEROFFER	PEROFFER contains the half-hourly period details of daily bids and rebids, to be used in conjunction with DAYOFFER. These views provide period varying details such as rate of change up (ROCUP), rate of change down (ROCDOWN) and band quantities (BANDAVAIL from 1 to 10). PEROFFER is a child table of DAYOFFER.
PEROFFER_D	PEROFFER_D contains the half-hourly period details of daily bids and rebids, to be used in conjunction with DAYOFFER_D. These views provide period varying details such as rate of change up (ROCUP), rate of change down (ROCDOWN) and band quantities (BANDAVAIL from 1 to 10). PEROFFER_D is a child table of DAYOFFER_D.
PREDISPATCBIDTRK	PREDISPATCBIDTRK contains an audit trail of bids used in each predispach run. Where predispach is over 2 days, two bids are listed.
REALLOCATIONDETAILS	REALLOCATIONDETAILS sets out specific reallocation agreements.
REALLOCATIONINTERVALS	REALLOCATIONINTERVALS identifies the the reallocation agreement and provides the corresponding reallocation profiles submitted by the participant and accepted by AEMO
REALLOCATIONS	REALLOCATIONS shows reallocation agreement identifiers with corresponding start and end dates of submitted reallocations as accepted by AEMO.
REGIONFCASRELAXATION_OCD	REGIONFCASRELAXATION_OCD contains details of regional FCAS requirements relaxed in the over-constrained dispatch (OCD) re-run (if there was one). Note: INTERVENTION is not included in REGIONFCASRELAXATION_OCD since the relaxation of the FCAS requirement is the same amount in both intervened and non-intervened cases.
SET_CSP_DEROGATION_AMOUNT	A settlement table for the publication of Snowy CSP derogation amounts.
SET_CSP_SUPPORTDATA_CONSTRAINT	A settlements table for the publication of support data for the Snowy CSP derogation amounts. This table publishes the constraint-level information for each five minute interval in the settlement run
SET_CSP_SUPPORTDATA_ENERGYDIFF	A settlements table for the publication of support data for the Snowy CSP derogation amounts. This table publishes energy differential information for each half-hour interval in the settlement run
SET_CSP_SUPPORTDATA_SUBPRICE	A settlements table for the publication of support data for the Snowy CSP derogation amounts. This table publishes substitution price information for each five minute interval in the settlement run
SETAPCCOMPENSATION	SETAPCCOMPENSATION shows Administered Price Cap (APC) compensation payments for each period.
SETAPCRECOVERY	SETAPCRECOVERY shows reimbursements for Administered Price Cap (APC) to be recovered from participants.
SETFCASRECOVERY	SETFCASRECOVERY shows reimbursements for the Frequency Control Ancillary Services compensation.
SETGOVPAYMENT	SETGOVPAYMENT shows specific payment details for Governor services by period.
SETGOVRECOVERY	SETGOVRECOVERY shows reimbursements for the Governor Ancillary Services to be recovered from participants.
SETLULOADPAYMENT	SETLULOADPAYMENT shows specific payment details for rapid unit load services by period.
SETRESERVETRADER	SETRESERVETRADER shows reserve trader details.
STPASA_SYSTEMSOLUTION	STPASA_SYSTEMSOLUTION is obsolete from 2005 End of Year

	Release. For solution information, see Region solution tables. STPASA_SYSTEMSOLUTION showed the results of the system capacity evaluations for each interval of the study.
STPASA_UNITSOLUTION	STPASA_UNITSOLUTION shows the unit results from the capacity evaluations for each period of the study.

## 14.2 Diagram: Entities: Historical Tables

These are not shown as the tables are no longer used

## 15 Package: IRAUCTION

<i>Name</i>	IRAUCTION
<i>Comment</i>	Inter-regional Residue Auction data

### 15.1 List of tables

Name	Comment
AUCTION	AUCTION holds auction details. AUCTION is new in March 2003 to support SRA Inter-Temporal Linking.
AUCTION_CALENDAR	AUCTION_CALENDAR holds the definitions of each auction quarter in a contract year. AUCTION_CALENDAR supports the Settlement Residue Auction.
AUCTION_IC_ALLOCATIONS	AUCTION_IC_ALLOCATIONS supports the Settlement Residue Auction by providing the basis for setting up contracts for individual tranches. AUCTION_IC_ALLOCATIONS shows the default definitions for the total number of units and proportion applicable to each directional interconnector for a specified auction quarter.
AUCTION_REVENUE_ESTIMATE	AUCTION_REVENUE_ESTIMATE supports the Settlement Residue Auction, by holding the evaluator's estimates of revenue for each month of a given quarter. Since reserve prices are no longer applicable from the end of 2001, zero is used as a default to avoid rewriting the system.
AUCTION_REVENUE_TRACK	AUCTION_REVENUE_TRACK supports the Settlement Residue Auction, by holding the tracking information for each evaluator's estimates for a given quarter. The status field is dynamic and is used for selection of estimates to be published.
AUCTION_RP_ESTIMATE	AUCTION_RP_ESTIMATE supports the Settlement Residue Auction, by holding the evaluator's estimates of revenue prices for a given quarter. Since reserve prices are no longer applicable from the end of 2001, zero is used as a default to avoid rewriting the system.
AUCTION_TRANCHE	AUCTION_TRANCHE supports the Settlement Residue Auction, by holding the default definitions for the percentage number of units allocated and dates applicable to each tranche for a specified auction quarter. This information provides the basis for setting up contracts for individual tranches.
RESIDUE_BID_TRK	RESIDUE_BID_TRK supports the Settlement Residue Auction, by detailing which bid was used for which SRA Contract run.
RESIDUE_CON_DATA	RESIDUE_CON_DATA supports the Settlement Residue Auction, by holding for each participant the confidential data from the auction. RESIDUE_CON_DATA joins to RESIDUE_PUBLIC_DATA and RESIDUE_TRK.
RESIDUE_CON_ESTIMATES_TRK	RESIDUE_CON_ESTIMATES_TRK supports the Settlement Residue Auction, by holding the tracking details of the estimates used to generate the reserve price for each contract.
RESIDUE_CON_FUNDS	RESIDUE_CON_FUNDS supports the Settlement Residue Auction, by holding the fund details for each contract.
RESIDUE_CONTRACTS	RESIDUE_CONTRACTS supports the Settlement Residue Auction, by holding the contract details for each period for which a residue contract will be offered.
RESIDUE_FUNDS_BID	RESIDUE_FUNDS_BID supports the Settlement Residue Auction, by showing the fund details for each SRA bid by each Participant.
RESIDUE_PRICE_BID	RESIDUE_PRICE_BID supports the Settlement Residue Auction, holding the unit and bid price details for each participant.

RESIDUE_PRICE_FUNDS_BID	RESIDUE_PRICE_FUNDS_BID shows the bids producing the auction outcome, without exposing participant-specific details. RESIDUE_PRICE_FUNDS_BID is new in March 2003 to support SRA Inter-Temporal Linking.
RESIDUE_PUBLIC_DATA	RESIDUE_PUBLIC_DATA shows the public auction results. RESIDUE_PUBLIC_DATA supports the Settlement Residue Auction, by holding the public details of the auction for a given contract. RESIDUE_PUBLIC_DATA joins to RESIDUE_CON_DATA and RESIDUE.
RESIDUE_TRK	RESIDUE_TRK supports the Settlement Residue Auction, by showing the tracking records for different residue auction runs. RESIDUE_TRK joins to RESIDUE_PUBLIC_DATA and RESIDUE_CON_DATA.
RESIDUECONTRACTPAYMENTS	RESIDUECONTRACTPAYMENTS shows Settlement Residue Auction payment Participant notifications.
RESIDUEFILETRK	RESIDUEFILETRK records all Settlement Residue Auction offers submitted by participants.
VALUATIONID	VALUATIONID shows the identifiers and descriptions of the valuers submitting estimates of upcoming settlement residues. VALUATIONID supports the Settlement Residue Auction.

## 15.2 Diagram: Entities: IRAuction

RESIDUEFILETRK
PARTICIPANTID
LOADDATE
AUCTIONID

RESIDUE_CON_FUNDS
CONTRACTID
INTERCONNECTORID
FROMREGIONID

RESIDUE_CON_DATA
CONTRACTID
VERSIONNO
PARTICIPANTID
INTERCONNECTORID
FROMREGIONID

RESIDUECONTRACTPAYMENTS
CONTRACTID
PARTICIPANTID

AUCTION_REVENUE_TRACK
CONTRACTYEAR
QUARTER
VALUATIONID
VERSIONNO

RESIDUE_CON_ESTIMATES_TRK
CONTRACTID
CONTRACTYEAR
QUARTER
VALUATIONID

AUCTION_TRANCHE
CONTRACTYEAR
QUARTER
VERSIONNO
TRANCHE

RESIDUE_PRICE_FUNDS_BID
CONTRACTID
INTERCONNECTORID
FROMREGIONID
LINKEDBIDFLAG
AUCTIONID

AUCTION
AUCTIONID

RESIDUE_PUBLIC_DATA
CONTRACTID
VERSIONNO
INTERCONNECTORID
FROMREGIONID

RESIDUE_PRICE_BID
PARTICIPANTID
LOADDATE
OPTIONID
AUCTIONID

AUCTION_CALENDAR
CONTRACTYEAR
QUARTER

RESIDUE_CONTRACTS
CONTRACTYEAR
QUARTER
TRANCHE

RESIDUE_TRK
VERSIONNO
AUCTIONID

AUCTION_RP_ESTIMATE
CONTRACTYEAR
QUARTER
VALUATIONID
VERSIONNO
INTERCONNECTORID
FROMREGIONID

VALUATIONID
VALUATIONID

RESIDUE_BID_TRK
VERSIONNO
PARTICIPANTID
AUCTIONID

AUCTION_IC_ALLOCATIONS
CONTRACTYEAR
QUARTER
VERSIONNO
INTERCONNECTORID
FROMREGIONID

RESIDUE_FUNDS_BID
CONTRACTID
PARTICIPANTID
LOADDATE
OPTIONID
INTERCONNECTORID
FROMREGIONID

AUCTION_REVENUE_ESTIMATE
CONTRACTYEAR
QUARTER
VALUATIONID
VERSIONNO
INTERCONNECTORID
FROMREGIONID
MONTHNO

## 16 Package: MARKET\_CONFIG

<i>Name</i>	MARKET_CONFIG
<i>Comment</i>	Standing data for the market

### 16.1 List of tables

Name	Comment
BIDTYPES	BIDTYPES, together with the associated tracking data in BIDTYPESTRK, define a set of ancillary services with bidding parameters from a given date. BIDTYPES is static data describing each type of bid quantity, the number of applicable bands, how many days ahead a price lock down becomes effective and the validation rule that applies.
BIDTYPESTRK	BIDTYPESTRK, together with the associated data in BIDTYPES, define a set of ancillary services with bidding parameters from a given date.
INTERCONNECTOR	INTERCONNECTOR sets out valid identifiers for each interconnector.
INTERCONNECTORALLOC	INTERCONNECTORALLOC shows allocations of interconnector residues to Network Service Providers.
INTERCONNECTORCONSTRAINT	INTERCONNECTORCONSTRAINT sets out Interconnector limit data used as defaults in dispatch, predispach and STPASA and used by SPD in calculating flows. INTERCONNECTORCONSTRAINT includes an additional field to restrict an interconnector from support transfer of FCAS.
INTRAREGIONALLOC	INTRAREGIONALLOC shows allocations of intra-regional residues to participants.
LOSSFACTORMODEL	LOSSFACTORMODEL sets out the demand coefficients for each interconnector, used by LP Solver modelling of interconnector flows.
LOSSMODEL	LOSSMODEL sets out segment breakpoints in loss model for each interconnector, used by LP Solver modelling of interconnector flows.
MARKET_PRICE_THRESHOLDS	MARKET_PRICE_THRESHOLDS sets out the market cap , floor and administered price thresholds applying to the electricity market
REGION	REGION sets out valid region IDs.
REGIONSTANDINGDATA	REGIONSTANDINGDATA sets out standing region data including the region reference node.
TRANSMISSIONLOSSFACTOR	TRANSMISSIONLOSSFACTOR shows the Transmission Loss factors applied at each connection point.



### 16.2 Diagram: Entities: Market Standing Data

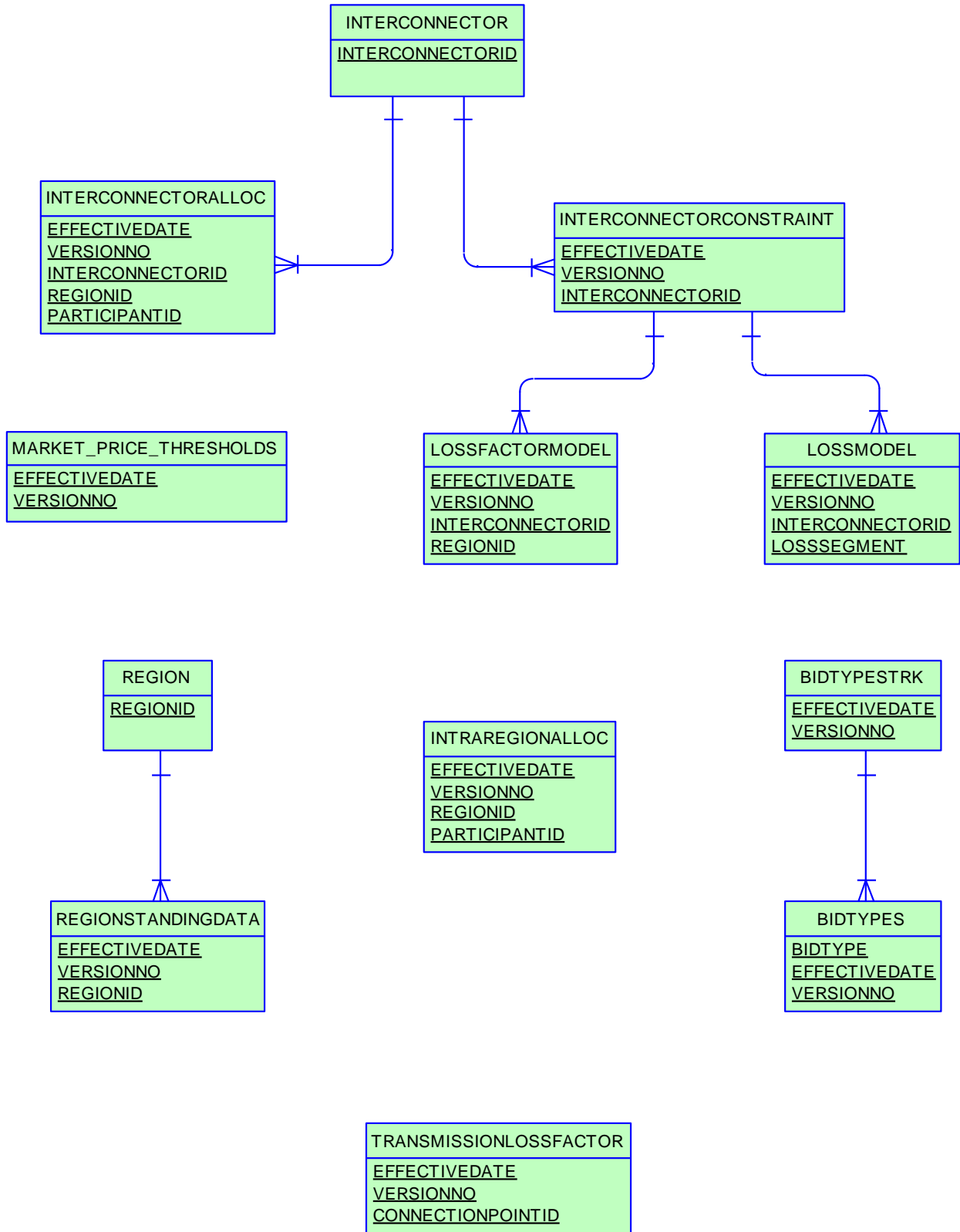

## 17 Package: MARKET\_NOTICE

<i>Name</i>	MARKET_NOTICE
<i>Comment</i>	Market Notice data

### 17.1 List of tables

Name	Comment
MARKETNOTICEDATA	MARKETNOTICEDATA shows market notices data provided to all participants (market) and specific participants (participant).
MARKETNOTICETYPE	MARKETNOTICETYPE sets out the different types of market notices (e.g. market systems).
PARTICIPANTNOTICETRK	PARTICIPANTNOTICETRK provides the cross-reference between participant market notices and participants.

### 17.2 Diagram: Entities: Market Notices

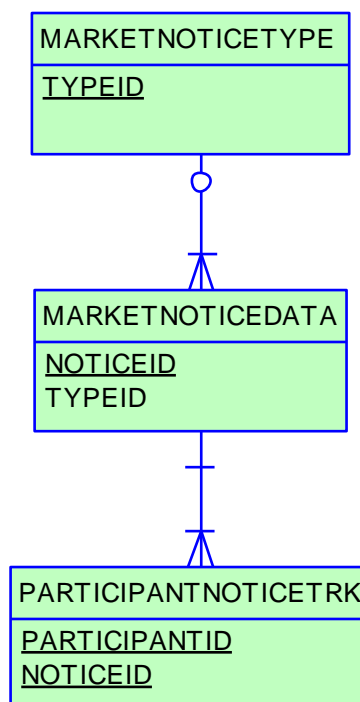

## 18 Package: MCC\_DISPATCH

<i>Name</i>	MCC_DISPATCH
<i>Comment</i>	Results from the Marginal Constraint Cost (MCC) re-run of the dispatch process. The MCC forms part of the part of the AER's "Electricity transmission network service providers Service target performance incentive Scheme"

### 18.1 List of tables

Name	Comment
MCC_CASESOLUTION	Top level table for each MCC dispatch rerun process. Note there will be one record for each dispatch interval
MCC_CONSTRAINTSOLUTION	Constraint solution data from the MCC dispatch rerun process. Note only constraints with a non-zero marginal value are published.

### 18.2 Diagram: Entities: MCC\_Dispatch

MCC_CASESOLUTION	
<u>RUN_DATETIME</u>	<u>DATE</u> <pk>

MCC_CONSTRAINTSOLUTION		
<u>RUN_DATETIME</u>	<u>DATE</u>	<pk>
<u>CONSTRAINTID</u>	<u>VARCHAR2(20)</u>	<pk>
RHS	NUMBER(15,5)	
MARGINALVALUE	NUMBER(15,5)	

## 19 Package: METER\_DATA

<i>Name</i>	METER_DATA
<i>Comment</i>	Wholesale market aggregated Meter data

### 19.1 List of tables

Name	Comment
METERDATA_AGGREGATE_READS	Publishes aggregated metering data associated with a wholesale connection point for a given CASE_ID
METERDATA_INDIVIDUAL_READS	Publishes metering data associated with individual metering points for a given CASE_ID
METERDATA_INTERCONNECTOR	Publishes metering data associated with wholesale interconnectors for a given CASE_ID
METERDATA_TRK	Tracking table for the publication of wholesale settlement data associated with BILLING run

## 19.2 Diagram: Entities: Meter Data

Note: Include MDA = MeteringDataAgent in any join

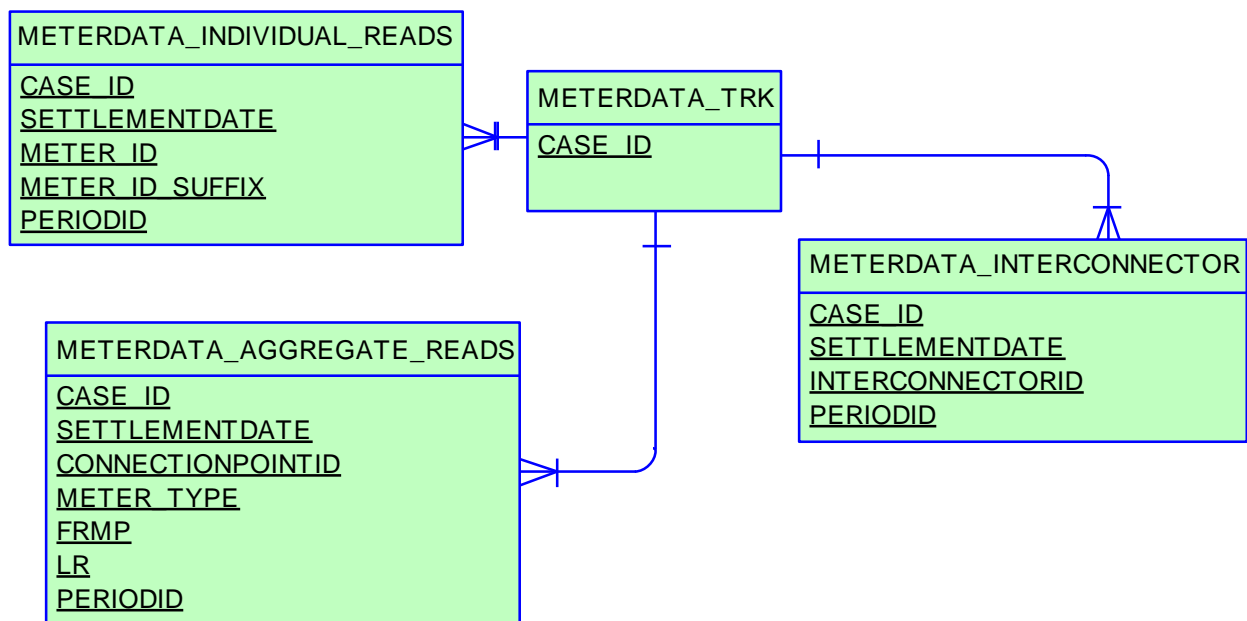

## 20 Package: MREVENT

<i>Name</i>	MREVENT
<i>Comment</i>	Mandatory Restrictions Event data

### 20.1 List of tables

Name	Comment
MR_DAYOFFER_STACK	MR_DAYOFFER_STACK defines the Stack order for each version of the Acceptance Schedule, including all units submitting MR offers for that event. MR_DAYOFFER_STACK is the child to MR_EVENT_SCHEDULE, and parent to MR_PEROFFER_STACK.
MR_EVENT	MR_EVENT defines an MR Event for a given region on a specific trading date.
MR_EVENT_SCHEDULE	MR_EVENT_SCHEDULE defines the Stack version of the Acceptance Schedule and is the parent table to MR_DayOffer_Stack and MR_PerOffer_Stack.
MR_PEROFFER_STACK	MR_PEROFFER_STACK defines the accepted capacity on a period basis for the Acceptance Schedule, is a child table to MR_DayOffer_Stack and only includes records or units with accepted_capacity > 0 for the specific period.

## 20.2 Diagram: Entities: MR Events

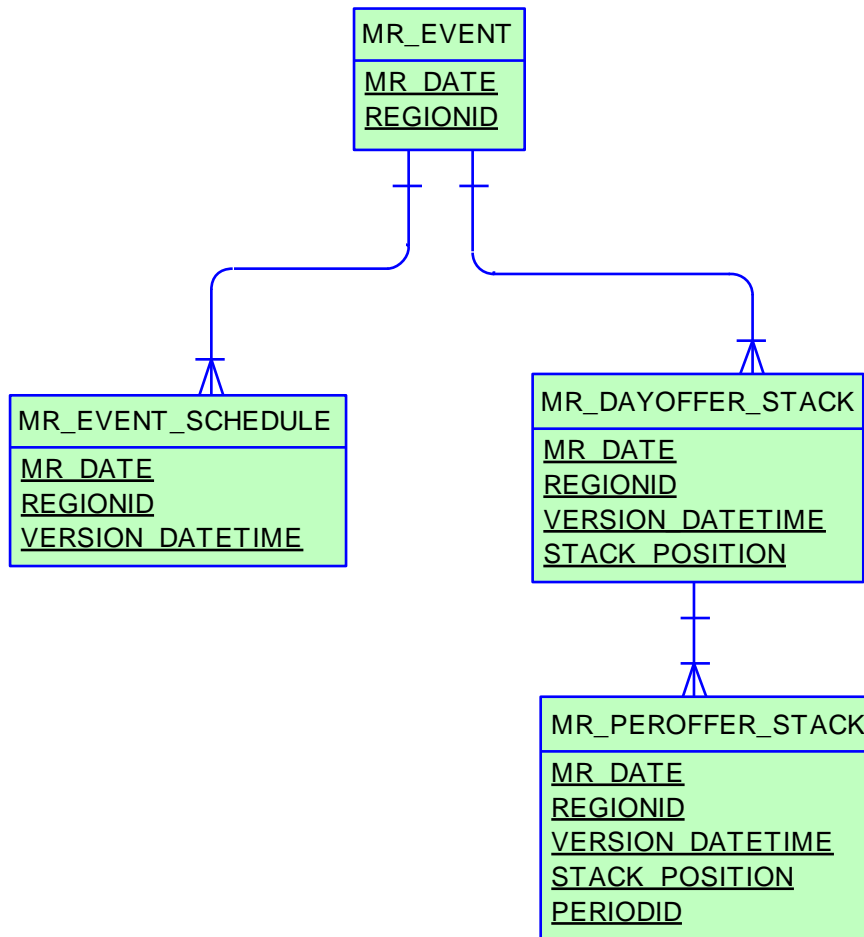

## 21 Package: MTPASA

<i>Name</i>	MTPASA
<i>Comment</i>	Results from a published Medium Term PASA Run and region-aggregate offered PASA Availability of scheduled generators

### 21.1 List of tables

Name	Comment
MTPASA_CASERESULT	MTPASA solution header table
MTPASA_CONSTRAINTRESULT	Constraint results for Binding or Violating Constraints
MTPASA_CONSTRAINTSUMMARY	Constraint Summary results over aggregation periods
MTPASA_INTERCONNECTORRESULT	Interconnector results for interval of max demand per day
MTPASA_LOLPRESULT	Results for Loss of Load Probability (LOLP) run per day
MTPASA_REGIONAVAIL_TRACK	The tracking table to assist in versioning of the region-aggregate offered PASA Availability data published to the MTPASA_REGIONAVAILABILITY table.
MTPASA_REGIONAVAILABILITY	Stores the Region-aggregate offered PASA Availability of scheduled generators for each day over the Medium Term PASA period. The data in this table is an aggregate of input data to the MT PASA process it is not part of the MTPASA solution. The aggregate availability does not reflect any energy limitations in the MT PASA offers.
MTPASA_REGIONITERATION	Region results for Unserved Energy (USE)
MTPASA_REGIONRESULT	Region results for interval of max demand per day.
MTPASA_REGIONSUMMARY	Region Results summary over aggregation periods.



## 21.2 Diagram: Entities: MT PASA

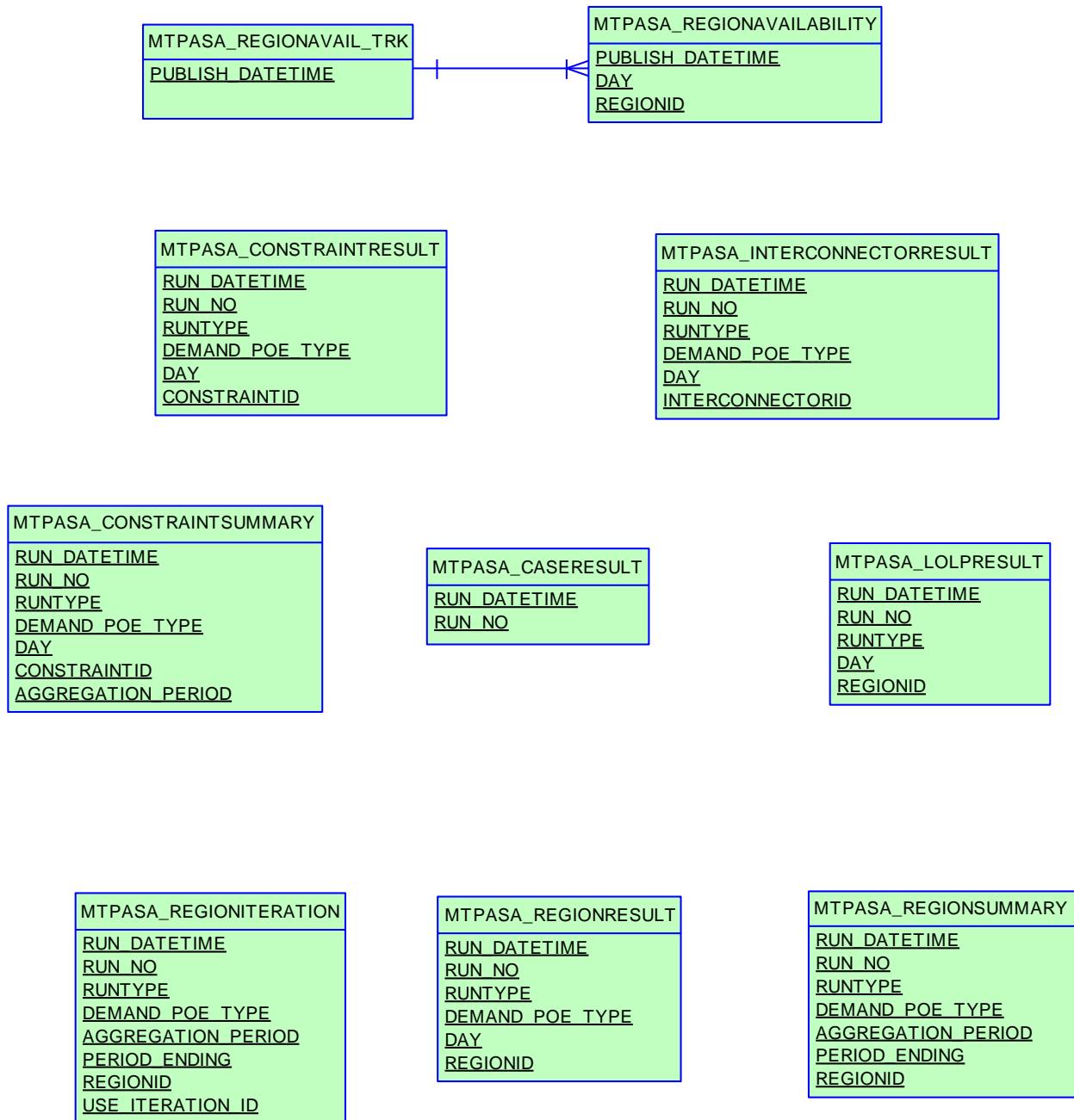

## 22 Package: NETWORK

<i>Name</i>	NETWORK
<i>Comment</i>	Configuration data for the physical network

### 22.1 List of tables

Name	Comment
NETWORK_EQUIPMENTDETAIL	NETWORK_EQUIPMENTDETAIL Provides details on equipment that may have outages or ratings. A single piece of equipment may have multiple records if its details change. A line will typically have at least two valid records at a time, once for each end of the line.
NETWORK_OUTAGECONSTRAINTSET	NETWORK_OUTAGECONSTRAINTSET lists the Constraint Set or Sets that are expected to be invoked for the outage once it is confirmed to proceed.
NETWORK_OUTAGEDetail	Lists asset owners planned outages for transmission equipment. This also includes details for transmission equipment that will not have an outage, but associated secondary equipment has an outage and a related constraint set may be invoked. This scenario is indicated by the ISSECONDARY field in the table
NETWORK_OUTAGESTATUSCODE	NETWORK_OUTAGESTATUSCODE describes the different outage status codes
NETWORK_RATING	NETWORK_RATING defines a list of the equipment ratings that may be used as inputs to market constraints. If the rating is flagged as dynamic then in real-time the rating will be dynamically determined and the static value will be used as a fallback value should the dynamic value fail. Note: In some rare cases equipment has ratings provided from more than one TNSP. This is identified by a different SPD Id. The value used in the NEM is normally the more restrictive of the two values.
NETWORK_REALTIMERATING	The NETWORK_REALTIMERATING table shows the equipment rating values in MVA used as inputs to constraints in the dispatch solution. This includes values for both static and dynamic ratings. The NETWORK_RATING table can be used to determine the physical equipment the rating is for based on the SPD_ID value.
NETWORK_STATICRATING	NETWORK_STATICRATING lists the static rating values that will apply for a Rating Application ID. This data does not provide information for when the rating actually applies in the NEM. This is dependent on the Rating Application definition. For information on the Rating Applications please refer to the information published on the AEMO website under the topic "Transmission Equipment Ratings". The Rating Applications are referred to as Alternate Value Application Ratings. Ratings that normally use dynamic values will also have static rating values defined. These are used as a fallback if the dynamic rating fails.
NETWORK_SUBSTATIONDETAIL	NETWORK_SUBSTATIONDETAIL sets out the attributes of substations across time

## 22.2 Diagram: Entities: NETWORK

NETWORK_SUBSTATIONDETAIL
<u>SUBSTATIONID</u>
<u>VALIDFROM</u>

NETWORK_EQUIPMENTDETAIL
<u>SUBSTATIONID</u>
<u>EQUIPMENTTYPE</u>
<u>EQUIPMENTID</u>
<u>VALIDFROM</u>

NETWORK_OUTAGEDDETAIL
<u>OUTAGEID</u>
<u>SUBSTATIONID</u>
<u>EQUIPMENTTYPE</u>
<u>EQUIPMENTID</u>
<u>STARTTIME</u>

NETWORK_OUTAGESTATUSCODE
<u>OUTAGESTATUSCODE</u>

NETWORK_OUTAGECONSTRAINTSET
<u>OUTAGEID</u>
<u>GENCONSETID</u>

NETWORK_RATING
<u>SPD_ID</u>
<u>VALIDFROM</u>

NETWORK_STATICRATING
<u>SUBSTATIONID</u>
<u>EQUIPMENTTYPE</u>
<u>EQUIPMENTID</u>
<u>RATINGLEVEL</u>
<u>APPLICATIONID</u>
<u>VALIDFROM</u>

NETWORK_REALTIMERATING
<u>SETTLEMENTDATE</u>
<u>SPD_ID</u>

## 23 Package: P5MIN

<i>Name</i>	P5MIN
<i>Comment</i>	Results from a published Five-Minute Predispatch Run

### 23.1 List of tables

Name	Comment
P5MIN_BLOCKEDCONSTRAINT	P5MIN Blocked Constraints lists any constraints that were blocked in a P5MIN run. If no constraints are blocked, there will be no rows for that 5 minute predispatch run.
P5MIN_CASESOLUTION	The five-minute predispatch (P5Min) is a MMS system providing projected dispatch for 12 Dispatch cycles (one hour). The 5-minute Predispatch cycle runs every 5-minutes to produce a dispatch and pricing schedule to a 5-minute resolution covering the next hour, a total of twelve periods. P5MIN_CASESOLUTION shows one record containing results pertaining to the entire solution.
P5MIN_CONSTRAINTSOLUTION	The Five-Minute Pre-Dispatch (P5Min) is a MMS system providing projected dispatch for 12 Dispatch cycles (one hour). The Five-Minute Pre-dispatch cycle runs every 5-minutes to produce a dispatch and pricing schedule to a 5-minute resolution covering the next hour, a total of twelve periods. P5MIN_CONSTRAINTSOLUTION shows binding and violated constraint results from the capacity evaluation, including the RHS value.
P5MIN_INTERCONNECTORSOLN	The five-minute predispatch (P5Min) is a MMS system providing projected dispatch for 12 Dispatch cycles (one hour). The 5-minute Predispatch cycle runs every 5-minutes to produce a dispatch and pricing schedule to a 5-minute resolution covering the next hour, a total of twelve periods. P5MIN_INTERCONNECTORSOLN sets out the results of the capacity evaluation for Interconnectors, including the calculated limits for the interval.
P5MIN_LOCAL_PRICE	Sets out local pricing offsets associated with each DUID connection point for each dispatch period
P5MIN_REGIONSOLUTION	The five-minute predispatch (P5Min) is a MMS system providing projected dispatch for 12 Dispatch cycles (one hour). The 5-minute Predispatch cycle runs every 5-minutes to produce a dispatch and pricing schedule to a 5-minute resolution covering the next hour, a total of twelve periods. P5MIN_REGIONSOLUTION shows the results of the regional capacity, maximum surplus reserve and maximum spare capacity evaluations for each period of the study.
P5MIN_UNITSOLUTION	The five-minute predispatch (P5Min) is a MMS system providing projected dispatch for 12 Dispatch cycles (one hour). The 5-minute Predispatch cycle runs every 5-minutes to produce a dispatch and pricing schedule to a 5-minute resolution covering the next hour, a total of twelve periods. P5MIN_UNITSOLUTION shows the Unit results from the capacity evaluations for each period of the study.

### 23.2 Diagram: Entities: P5MIN

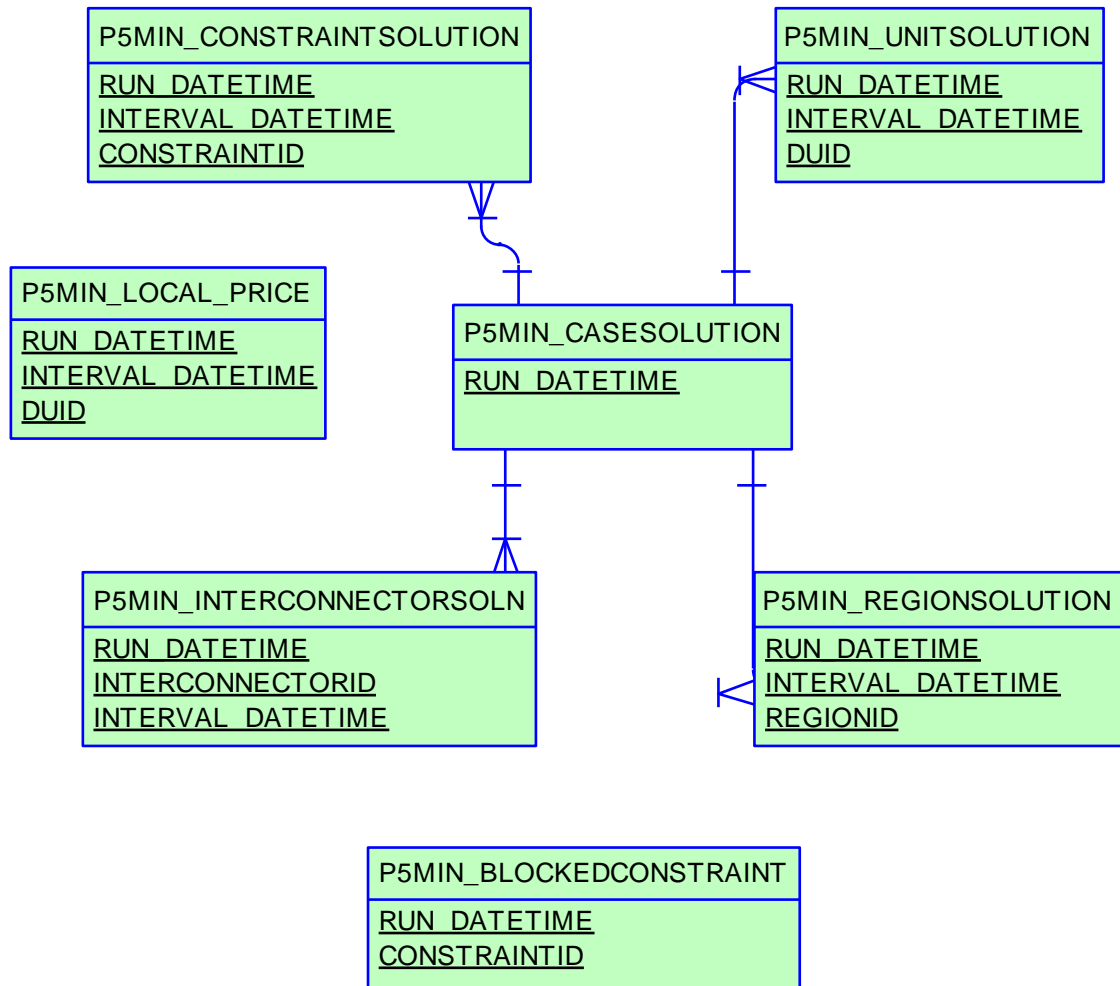

## 24 Package: PARTICIPANT\_REGISTRATION

<i>Name</i>	PARTICIPANT_REGISTRATION
<i>Comment</i>	Participant registration data

### 24.1 List of tables

Name	Comment
BIDDUIDDETAILS	BIDDUIDDETAILS and the associated tracking object BIDDUIDDETAILSTRK define the registration data for each ancillary service a dispatchable unit is registered to provide. The registration data is required to validate a dispatchable unit bid submitted for that ancillary service.
BIDDUIDDETAILSTRK	BIDDUIDDETAILSTRK shows the tracking for the associated object BIDDUIDDETAILS. Together, BIDDUIDDETAILSTRK and BIDDUIDDETAILS define the registration data for each ancillary service a dispatchable unit is registered to provide. The registration data is required to validate a dispatchable unit bid submitted for that ancillary service.
DISPATCHABLEUNIT	DISPATCHABLEUNIT sets out the unit name and type of each dispatchable unit in the market.
DUALLOC	DUALLOC cross references dispatch unit identifier to genset ID for each participant.
DUDETAIL	DUDETAIL sets out a records specific details for each unit including start type and whether normally on or off load. Much of this data is information only and is not used in dispatch or settlements.
DUDETAILSUMMARY	DUDETAILSUMMARY sets out a single summary unit table so reducing the need for participants to use the various dispatchable unit detail and owner tables to establish generating unit specific details.
GENMETER	GENMETER shows details of generator meter sets.
GENUNITS	GENUNITS shows Genset details for each physical unit with the relevant station.
GENUNITS_UNIT	Physical units within a Gen Unit Set
MNSP_INTERCONNECTOR	MNSP_INTERCONNECTOR sets out attributes of each interconnector.
MNSP_PARTICIPANT	MNSP_PARTICIPANT registers MNSP ownership.
PARTICIPANT	PARTICIPANT sets out Participant ID, name and class for all participants.
PARTICIPANTACCOUNT	PARTICIPANTACCOUNT shows financial details on participants.
PARTICIPANTCATEGORY	PARTICIPANTCATEGORY sets out valid participant categories.
PARTICIPANTCATEGORYALOC	PARTICIPANTCATEGORYALOC sets out the assignment of participants to particular categories.
PARTICIPANTCLASS	PARTICIPANTCLASS sets out valid participant classifications.
PARTICIPANTCREDITDETAIL	
STADUALLOC	STADUALLOC sets out details on the allocation of dispatchable units to particular sites or stations.
STATION	STATION sets out valid station identifiers.
STATIONOPERATINGSTATUS	STATIONOPERATINGSTATUS sets out the operating status of each station.
STATIONOWNER	STATIONOWNER sets out the owner details of each station.
STATIONOWNERTRK	STATIONOWNERTRK shows the tracking for the associated object STATIONOWNER. Together, STATIONOWNERTRK and STATIONOWNER sets out the owner details of each station.

## 24.2 Diagram: Entities: Participant Registration

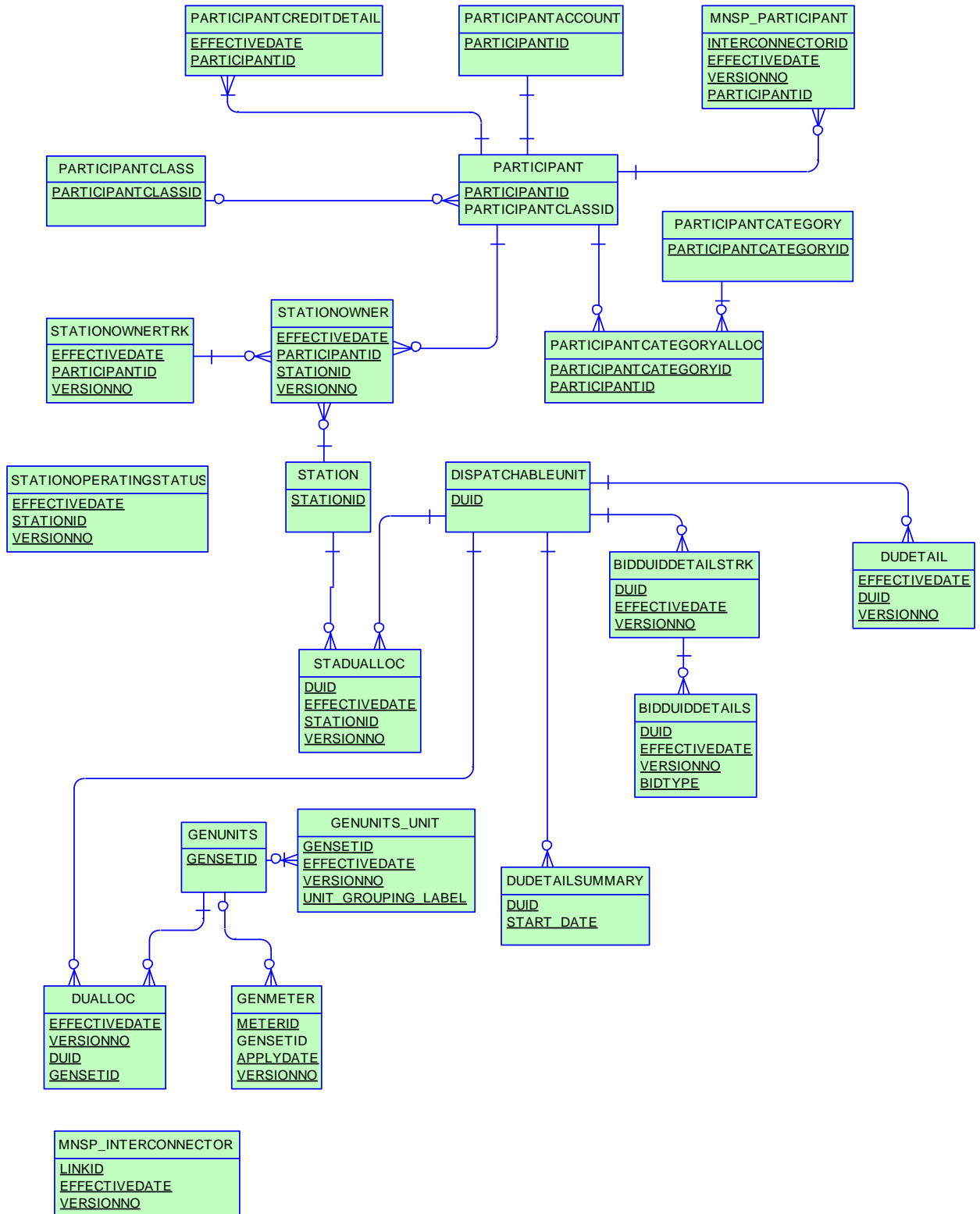

## 25 Package: PDPASA

*Name* PDPASA

*Comment* The PDPASA package provides a 30-minute solving process to the Market systems

The current methodology for calculating reserves in the PreDispatch timeframe is determined in a post processing step using a heuristic calculation based the results and Interconnector limits from the PreDispatch run.

The calculation is a reserve assessment based on the PASA solver similar to existing ST and MT PASA business processes

The process reflects all intra-regional and inter-regional network constraints as an input to the process

### 25.1 List of tables

Name	Comment
PDPASA_CASESOLUTION	The top-level table identifying a PDPASA case, reporting options applied in the case and summary results
PDPASA_REGIONSOLUTION	The PDPASA region solution data

### 25.2 Diagram: Entities: PD PASA

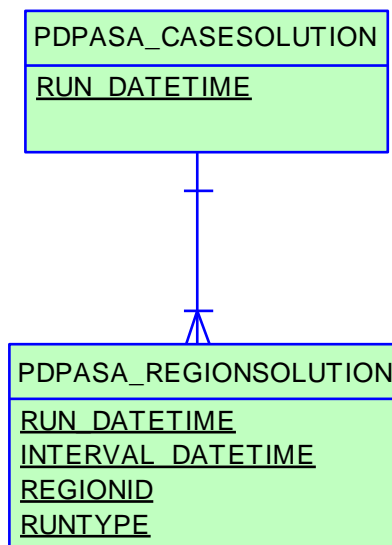



## 26 Package: PRE\_DISPATCH

<i>Name</i>	PRE_DISPATCH
<i>Comment</i>	Results from a published Predispatch Run

### Storage options

There are 2 ways to define the Pre-dispatch table primary keys (PKs) to define which data is loaded to the database and which data is retained:

#### Option 1 (default)

Overwrite older records when they are succeeded by later versions for the same entity and period. This is the Data Model default and results in the consumption of far less storage. Data Model updates issued by AEMO target this configuration so participants implementing option 2a or 2b must maintain their changes when AEMO releases a new Data Model version.

PredispatchLoad: DateTime, DUID

PredispatchInterconnectorRes: DateTime, InterconnectorID,

PredispatchPrice: DateTime, RegionID

PredispatchPriceSensitivities: DateTime, RegionID

PredispatchInterSensitivities: InterconnectorID, DateTime

#### Option 2a

Retain only the Pricing records for tables relating to Price data and Physical records for tables relating to Physical data (e.g. targets). Approximately 50 times more storage volumes than option 1.

PredispatchLoad: PredispatchSeqNo, DateTime, DUID

PredispatchInterconnectorRes: PredispatchSeqNo, DateTime, InterconnectorID,

PredispatchPrice: PredispatchSeqNo, DateTime, RegionID

PredispatchPriceSensitivities: PredispatchSeqNo, DateTime, RegionID

PredispatchInterSensitivities: PredispatchSeqNo, DateTime, InterconnectorID

#### Option 2b

Retain both Physical and Pricing data for Intervention runs. If Intervention cases are stored in entirety, you must select the data carefully. The logic is the same as for Dispatch, i.e. Intervention Pricing is always where Intervention = 0 and Physical data is where Intervention = PredispatchCaseSolution.Intervention for the same PredispatchSeqNo.

Doubles the storage of option 2a but ONLY for Intervened cases.

PredispachLoad: PredispachSeqNo, Intervention, DateTime, DUID

PredispachInterconnectorRes: PredispachSeqNo, Intervention, DateTime, InterconnectorID,

PredispachPrice: PredispachSeqNo, Intervention, DateTime, RegionID

PredispachPriceSensitivities: PredispachSeqNo, Intervention, DateTime, RegionID

PredispachInterSensitivities: PredispachSeqNo, Intervention, DateTime, InterconnectorID

#### Notes:

The data in the PredispachIS file is always ordered so the pdrLoader overwrites earlier data or adds each data set in its entirety, depending on how the PKs are defined.

You may order the PKs in a different order, depending on your local requirements. Any decision to change the PK column composition or order must consider the functional and performance impacts to existing applications or queries.

The pdrLoader caches PK definitions for performance reasons so any change to the PKs requires a restart of the application.

The TRANSACTION\_TYPE default in the PDR\_REPORT\_RECORDS management tables for PREDISPATCH\* tables is UPDATE-INSERT. You can modify this to INSERT for Option 2b, as the attempt to first perform an update becomes redundant. This can improve load performance.

## 26.1 List of tables

Name	Comment
PREDISPATCH_FCAS_REQ	PREDISPATCH_FCAS_REQ shows Predispach Constraint tracking for Regional FCAS Requirements.
PREDISPATCH_LOCAL_PRICE	Sets out local pricing offsets associated with each DUID connection point for each dispatch period
PREDISPATCH_MNSPBIDTRK	PREDISPATCH_MNSPBIDTRK shows the MNSP bid tracking, including the bid version used in each predispach run for each MNSP Interconnector Link. PREDISPATCH_MNSPBIDTRK shows the audit trail of the bid used for each predispach run.
PREDISPATCHBLOCKEDCONSTRAINT	PREDISPATCH Blocked Constraints lists any constraints that were blocked in a Predispach run. If no constraints are blocked, there will be no rows for that predispach run.
PREDISPATCHCASESOLUTION	PREDISPATCHCASESOLUTION provides information relating to the complete predispach run. The fields provide an overview of the dispatch run results allowing immediate identification of conditions such as energy or FCAS deficiencies.
PREDISPATCHCONSTRAINT	PREDISPATCHCONSTRAINT sets out constraints that are binding

	<p>in each predispach run and interconnector constraints (whether binding or not). Only binding and interconnector constraints are reported. Binding contracts have marginal value greater than \$0. Interconnector constraints are listed so RHS values can be reported for ST PASA.</p> <p>Constraint solutions only report fixed loading /MR constraints on the next day.</p>
PREDISPATCHINTERCONNECTORRES	<p>PREDISPATCHINTERCONNECTORRES records Interconnector flows and losses for the periods calculated in each predispach run. Only binding and interconnector constraints are reported.</p> <p>Some fields are for the Frequency Controlled Ancillary Services export and import limits and extra reporting of the generic constraint setting the energy import and export limits.</p>
PREDISPATCHINTERSENSITIVITIES	<p>PREDISPATCHINTERSENSITIVITIES sets out the sensitivity flows for each interconnector by period.</p>
PREDISPATCHLOAD	<p>PREDISPATCHLOAD shows pre-dispatch targets for each dispatchable unit, including additional fields to handle the Ancillary Services functionality. No record is written where a unit is not dispatched. PREDISPATCHLOAD shows all the results for each period.</p>
PREDISPATCHOFFERTRK	<p>PREDISPATCHOFFERTRK is for the ancillary service bid tracking of predispach processing. PREDISPATCHOFFERTRK identifies which bids from BIDDAYOFFER and BIDPEROFFER were applied for a given unit and ancillary service for each predispach run.</p>
PREDISPATCHPRICE	<p>PREDISPATCHPRICE records predispach prices for each region by period for each predispach run, including fields to handle the Ancillary Services functionality.</p>
PREDISPATCHPRICESENSITIVITIES	<p>PREDISPATCHPRICESENSITIVITIES sets out the sensitivity prices for each region by period.</p>
PREDISPATCHREGIONSUM	<p>PREDISPATCHREGIONSUM sets out the overall regional Pre-Dispatch results for base case details (excluding price).</p>
PREDISPATCHSCENARIODEMAND	<p>PREDISPATCHSCENARIODEMAND defines the demand offsets that are applied for each of the predispach sensitivity scenarios.</p>
PREDISPATCHSCENARIODEMANDTRK	<p>Tracks the predispach scenario offset updates across time</p>

## 26.2 Diagram: Entities: Predispatch

PREDISPATChCASESOLUTION
<u>PREDISPATChSEQNO</u>
<u>RUNNO</u>

PREDISPATChINTERCONNECTORRES
<u>INTERCONNECTORID</u>
<u>DATETIME</u>

PREDISPATChLOAD
<u>DUID</u>
<u>DATETIME</u>

PREDISPATChCONSTRAINT
<u>CONSTRAINTID</u>
<u>DATETIME</u>

PREDISPATChPRICESENSITIVITIES
<u>REGIONID</u>
<u>DATETIME</u>

PREDISPATChREGIONSUM
<u>REGIONID</u>
<u>DATETIME</u>

PREDISPATChOFFERTRK
<u>PREDISPATChSEQNO</u>
<u>DUID</u>
<u>BIDTYPE</u>
<u>PERIODID</u>

PREDISPATChPRICE
<u>REGIONID</u>
<u>DATETIME</u>

PREDISPATCh_MNSPBIDTRK
<u>PREDISPATChSEQNO</u>
<u>LINKID</u>
<u>PERIODID</u>

PREDISPATChSCENARIODEMAND
<u>EFFECTIVEDATE</u>
<u>VERSIONNO</u>
<u>SCENARIO</u>
<u>REGIONID</u>

PREDISPATCh_FCAS_REQ
<u>GENCONID</u>
<u>REGIONID</u>
<u>BIDTYPE</u>
<u>DATETIME</u>

PREDISPATChINTERSENSITIVITIES
<u>INTERCONNECTORID</u>
<u>DATETIME</u>

PREDISPATChSCENARIODEMANDTRK
<u>EFFECTIVEDATE</u>
<u>VERSIONNO</u>

PREDISPATChBLOCKEDCONSTRAINT
<u>PREDISPATChSEQNO</u>
<u>CONSTRAINTID</u>

PREDISPATCh_LOCAL_PRICE
<u>DATETIME</u>
<u>DUID</u>

## 27 Package: PRUDENTIALS

*Name* PRUDENTIALS  
*Comment* Prudential Management

### 27.1 List of tables

Name	Comment
PRUDENTIALCOMPANYPOSITION	The prudential position of each company as at the datetime of a specific prudential run
PRUDENTIALRUNTRK	Records the prudential run accepted by Settlements staff for each prudential date

### 27.2 Diagram: Entities:Prudentials

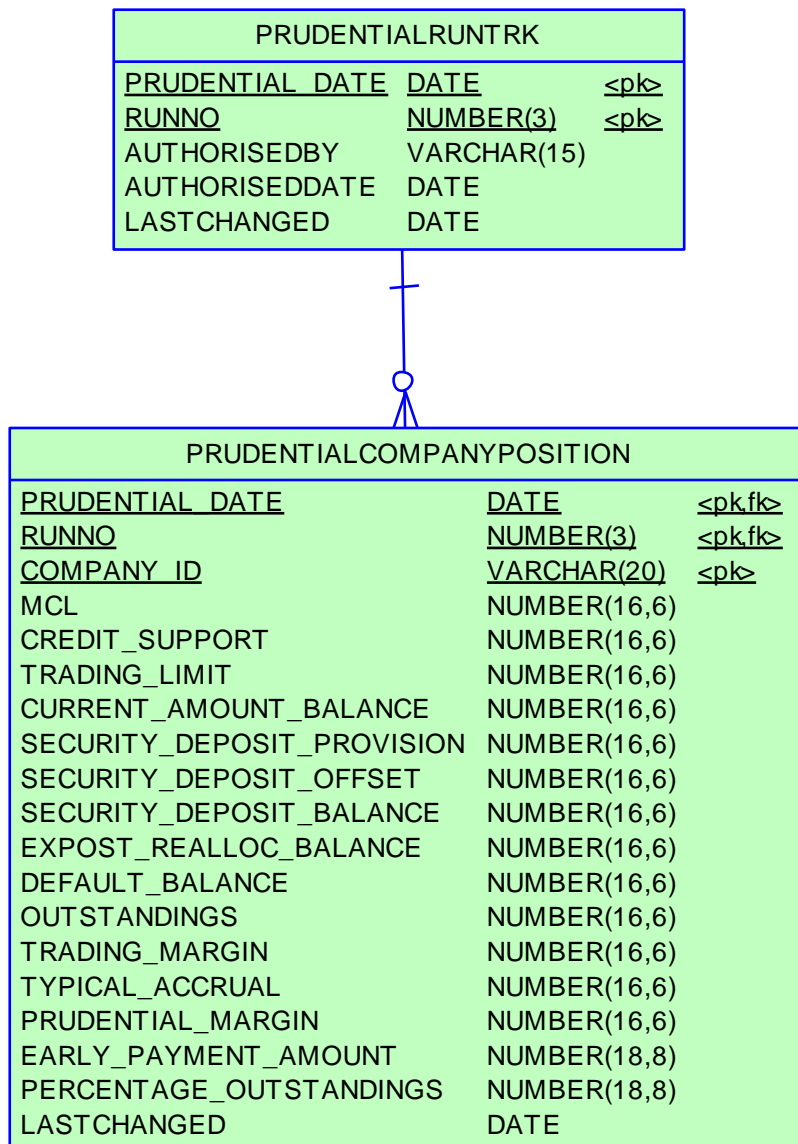

## 28 Package: RESERVE\_DATA

<i>Name</i>	RESERVE_DATA
<i>Comment</i>	Energy and FCAS reserve requirements

### 28.1 List of tables

Name	Comment
MTPASA_RESERVELIMIT	MT PASA input table defining a MT PASA Reserve Requirement within a single set. An MT PASA Reserve Requirement can span more than one region.
MTPASA_RESERVELIMIT_REGION	MT PASA input table to define the regions that are part of a single MT PASA Reserve Requirement
MTPASA_RESERVELIMIT_SET	MT PASA input table defining a set of MT PASA Reserve Requirements. Note only one set can be active on a given date.
RESERVE	RESERVE sets out specific reserve requirements for dispatch, predispach and STPASA, for each half-hour interval by region. Updates show as new versions for a date.

## 28.2 Diagram: Entities: Reserve Data

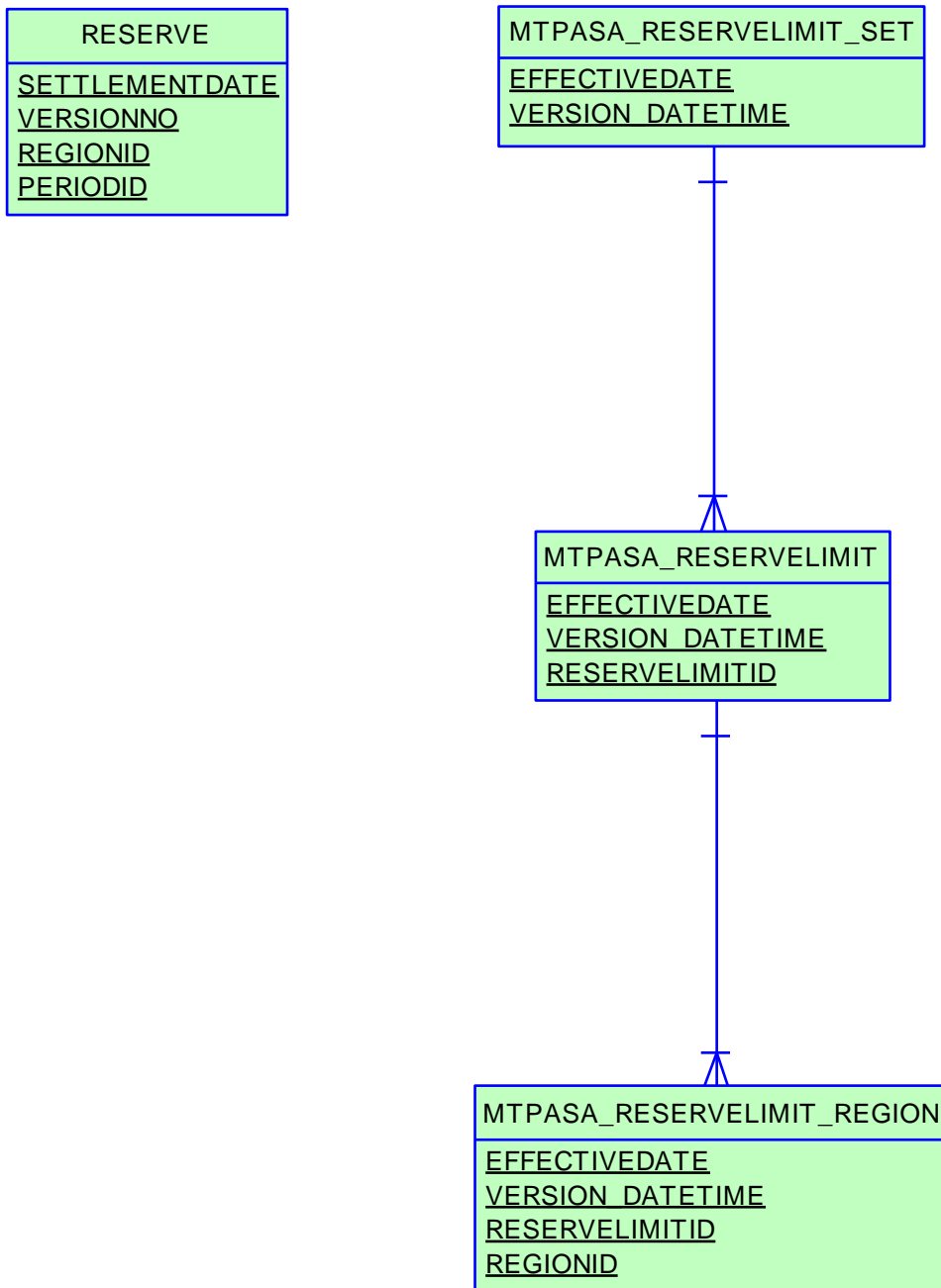

## 29 Package: SETTLEMENT\_CONFIG

<i>Name</i>	SETTLEMENT_CONFIG
<i>Comment</i>	Configuration and input data for the Settlements Process

### 29.1 List of tables

Name	Comment
ANCILLARY_RECOVERY_SPLIT	ANCILLARY_RECOVERY_SPLIT holds the actual customer portion for each service and payment type. A single EFFECTIVEDATE/VERSIONNO combination applies to all services (i.e. the latest EFFECTIVEDATE/VERSIONNO is not retrieved for a single service, but applies to a data set).
MARKET_FEE_CAT_EXCL	Market fee exclusions for participant categories.
MARKET_FEE_CAT_EXCL_TRK	Tracking table for market fee exclusions for participant categories.
MARKET_FEE_EXCLUSION	MARKET_FEE_EXCLUSION shows the list of market fees from which a participant is excluded from funding after a particular settlement date.
MARKET_FEE_EXCLUSION_TRK	MARKET_FEE_EXCLUSION_TRK shows authorisation details of participant market fee exclusion data sets.
MARKETFEE	MARKETFEE sets out fee type and period for each market fee.
MARKETFEEDATA	MARKETFEEDATA sets out actual fee rates, as adjusted from time to time.
MARKETFEETRK	MARKETFEETRK sets out versions of each market fee used and its effective date.
PARTICIPANT_BANDFEE_ALLOC	PARTICIPANT_BANDFEE_ALLOC shows the market fee for each Participant/Participant Category over time.
REALLOCATION	The REALLOCATION table shows the financial transactions agreed between two participants that are settled through the AEMO pool settlements process.
REALLOCATIONINTERVAL	Half-hour data comprising a single reallocation transaction.
SETCFG_PARTICIPANT_MPF	SETCFG_PARTICIPANT_MPF shows the Market Participation Factors (MPF) for each participant for each connection point. The MPF values are used to determine recovery amounts for regulation FCAS.
SETCFG_PARTICIPANT_MPF_TRK	SETCFG_PARTICIPANT_MPF_TRK is the tracking table for Market Participation Factors (MPF) data stored in the SETCFG_PARTICIPANT_MPF table for each participant.



## 29.2 Diagram: Entities: Settlement Config

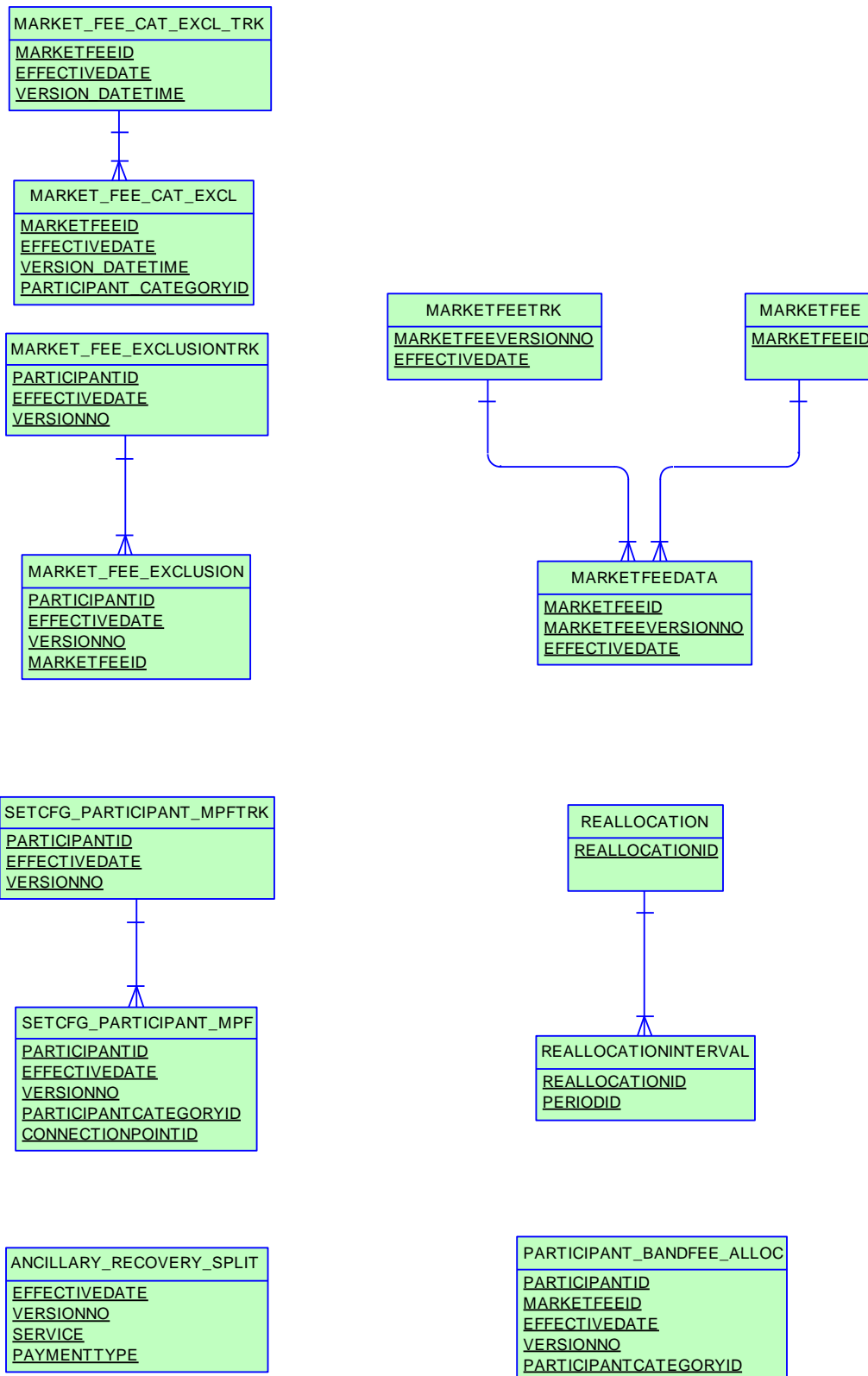

## 30 Package: SETTLEMENT\_DATA

<i>Name</i>	SETTLEMENT_DATA
<i>Comment</i>	Results from a published Settlements Run. The settlement data and billing run data are updated daily between 6am and 8am for AEMO's prudential processes. In a normal week, AEMO publishes one PRELIM, one FINAL and two REVISION runs in addition to the daily runs.

### 30.1 List of tables

Name	Comment
DAYTRACK	DAYTRACK identifies the actual settlement run processed for each settlement day. Settlement run is in the column EXPOSTRUNNO. Generally the number of the settlement run used in the latest statement is the maximum number.
SET_APC_COMPENSATION	APC Compensation payment amounts in the Settlements timeframe
SET_APC_RECOVERY	APC Compensation recovery amounts in the Settlements timeframe
SET_ANCILLARY_SUMMARY	SET_ANCILLARY_SUMMARY summarises payments for all Ancillary Services to participants on the basis of regions and trading intervals.
SET_FCAS_PAYMENT	SET_FCAS_PAYMENT sets out the enabling payment details for frequency controlled Ancillary Services.
SET_FCAS_RECOVERY	SET_FCAS_RECOVERY shows reimbursements for the Frequency Control Ancillary Services (FCAS) to be recovered from participants. Beware of potential confusion with the table SETFCASRECOVERY, which reports reimbursements for Frequency Control Ancillary Services Compensation (now unused).
SET_FCAS_REGULATION_TRK	SET_FCAS_REGULATION_TRK shows FCAS Regulation Service Constraint tracking for Regional FCAS Regulation recovery
SET_MR_PAYMENT	SET_MR_PAYMENT shows trading interval payments on a dispatchable unit basis for accepted MR capacity.
SET_MR_RECOVERY	SET_MR_RECOVERY shows the trading interval recovery charges on a dispatchable unit basis for spot market income from dispatch of MR capacity.
SET_NMAS_RECOVERY	SET_NMAS_RECOVERY sets out the NSCAS recovery data for payments other than testing.
SET_NMAS_RECOVERY_RBF	SET_NMAS_RECOVERY_RBF publishes the RBF for NSCAS non testing payments on a half hourly basis.
SET_RUN_PARAMETER	SET_RUN_PARAMETER shows the input parameters and value associated with each settlement run (e.g. Residual System Load Causer Pays Factor).
SETAGCPAYMENT	SETAGCPAYMENT sets out specific payment details for Automatic Generation Control (AGC) services by period.
SETAGCRECOVERY	SETAGCRECOVERY shows reimbursements for Automatic Generation Control (AGC) Ancillary Services to be recovered from participants.
SETCPDATA	SETCPDATA shows meter settlement data for each connection point. This is the key view for retailers to verify energy charges. A regional summary view is also provided. As the view has values for each connection point by period, for each meter data file, it is a very large view.
SETCPDATAREGION	SETCPDATAREGION sets out summary meter settlement data for each region.
SETFCASCOMP	SETFCASCOMP shows the compensation details for Frequency

	Controlled Ancillary Services (FCAS). These compensation values are calculated by a separate “what if” run of the LP Solver and entered as an unconstrained MW value into settlements.
SETFCASREGIONRECOVERY	SETFCASREGIONRECOVERY shows FCAS Regional Recovery Data against each Trading Interval.
SETGENDATA	SETGENDATA shows meter settlement data for each generation meter point. A regional summary is also provided.
SETGENDATAREGION	SETGENDATAREGION sets out summary settlement data for generation within the specified region.
SETINTERVENTION	SETINTERVENTION shows intervention settlement payment details by unit.
SETINTERVENTIONRECOVERY	SETINTERVENTIONRECOVERY shows intervention recovery details by participant.
SETINTRAREGIONRESIDUES	
SETIRAUCSURPLUS	This view supports the Settlements Residue Auction, by holding the NSP participant allocations of IRSurplus arising as a result of the unsold units for a quarter.
SETIRFMRECOVERY	SETIRFMRECOVERY sets out reimbursements for Industrial Relations Force Majeure to be recovered from participants.
SETIRNSPSURPLUS	This view supports the Settlements Residue Auction, by showing the TNSP participant allocations of Interconnector Residue (IR) Surplus (i.e. derogated amounts) arising as a result of the sold units for a quarter.
SETIRPARTSURPLUS	This view supports the Settlements Residue Auction, holding the participant allocations of IRSurplus.
SETIRSURPLUS	SETIRSURPLUS records the interregional residue calculation for each interconnector and each side of the interconnector.
SETLSHEDPAYMENT	SETLSHEDPAYMENT shows specific payment details for load shed services by period.
SETLSHEDRECOVERY	SETLSHEDRECOVERY shows reimbursements for Load shed Ancillary Services to be recovered from participants. (Data no longer created for Settlement Days from 01/07/2012)
SETLULOADRECOVERY	SETLULOADRECOVERY shows reimbursements for rapid-unit-load Ancillary Services to be recovered from participants.
SETLUNLOADPAYMENT	SETLUNLOADPAYMENT shows specific payment details for rapid unit unload service.
SETLUNLOADRECOVERY	SETLUNLOADRECOVERY shows reimbursements for rapid unit unloading Ancillary Services to be recovered from participants.
SETMARKETFEEES	SETMARKETFEEES shows payments for market fees for each settlement date.
SETREALLOCATIONS	SETREALLOCATIONS shows the trading interval value of reallocations processed, for those participants whose reallocation submissions have been accepted by AEMO.
SETRESERVERECOVERY	SETRESERVERECOVERY shows reserve recovery details.
SETRESTARTPAYMENT	SETRESTARTPAYMENT shows specific payment details for System Restart services by period.
SETRESTARTRECOVERY	SETRESTARTRECOVERY shows reimbursements for system restart Ancillary Services to be recovered from participants. (Data no longer created for Settlement Days from 01/07/2012)
SETRPOWERPAYMENT	SETRPOWERPAYMENT shows specific payment details for Reactive power services by period.
SETRPOWERRECOVERY	SETRPOWERRECOVERY shows reimbursements for Reactive Power Ancillary Services to be recovered from participants. (Data no longer created for Settlement Days from 01/07/2012)
SETSMALLGENDATA	Publishes metering data and associated settlement values for with a registered Small Generator Aggregator participants connection points.
SETVICBOUNDARYENERGY	SETVICBOUNDARYENERGY is as requested by Participants for

	the settlement of Victorian Vesting contracts.
SETVICENERGYFIGURES	SETVICENERGYFIGURES is used in settlement of Victorian Vesting contracts.
SETVICENERGYFLOW	SETVICENERGYFLOW is used in settlement of Victorian Vesting contracts.

### 30.2 Diagram: Entities: Settlement Data

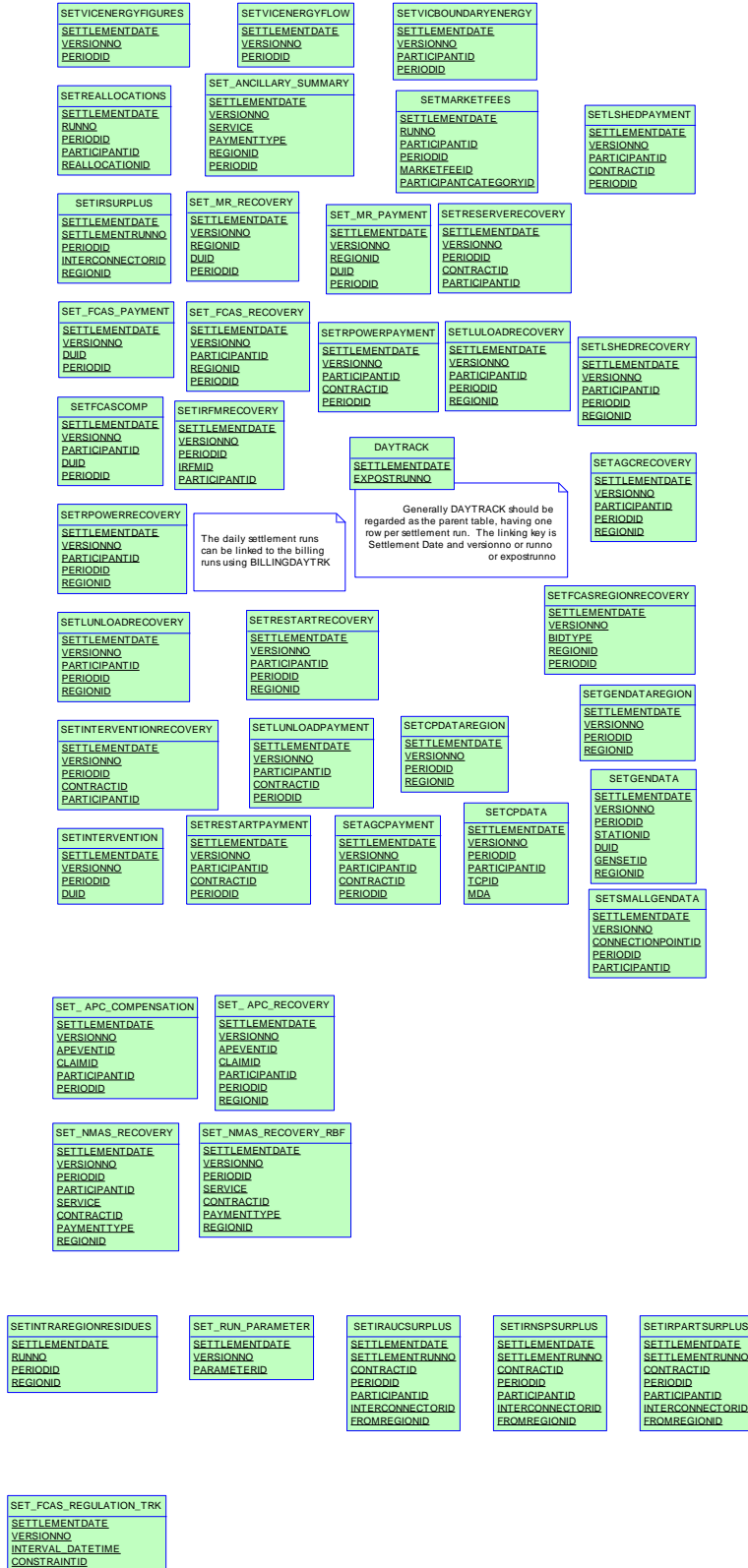



### 31 Package: STPASA\_SOLUTION

*Name* STPASA\_SOLUTION  
*Comment* Results from a published Short Term PASA Run

#### 31.1 List of tables

Name	Comment
STPASA_CASESOLUTION	STPASA_CASESOLUTION holds one record containing results pertaining to each entire solution
STPASA_CONSTRAINTSOLUTION	STPASA_CONSTRAINTSOLUTION shows binding and violated constraint results from the capacity evaluation, including the RHS value.
STPASA_INTERCONNECTORSOLN	STPASA_INTERCONNECTORSOLN shows the results of the capacity evaluation for Interconnectors, including the calculated limits for the interval.
STPASA_REGIONSOLUTION	STPASA_REGIONSOLUTION shows the results of the regional capacity, maximum surplus reserve and maximum spare capacity evaluations for each period of the study.

#### 31.2 Diagram: Entities: ST PASA Solution

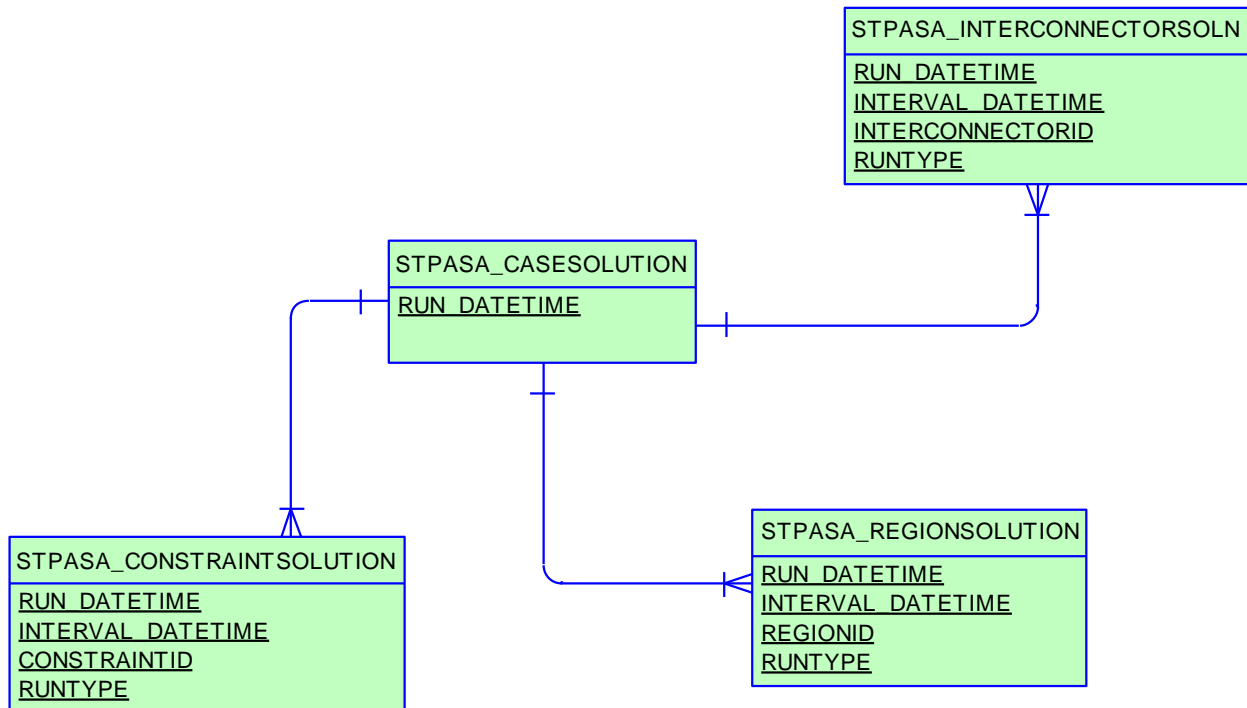

## 32 Package: TRADING\_DATA

<i>Name</i>	TRADING_DATA
<i>Comment</i>	30 minute Trading interval results

### 32.1 List of tables

Name	Comment
TRADINGINTERCONNECT	TRADINGINTERCONNECT shows the half-hourly summary of Interconnector flows based on 5-minute averages.
TRADINGLOAD	TRADINGLOAD shows half-hourly average dispatch levels, including fields to handle the Ancillary Services functionality.
TRADINGPRICE	TRADINGPRICE sets out half-hourly spot market price, including fields to handle the Ancillary Services functionality. If prices are adjusted, the final price is recorded in the regional reference price (RRP) field with price before adjustment recorded in the regional original price (ROP) field.
TRADINGREGIONSUM	TRADINGREGIONSUM sets out the half-hourly average regional demand and frequency control services. TRADINGREGIONSUM includes fields for the Raise Regulation and Lower Regulation Ancillary Services plus improvements to demand calculations.

### 32.2 Diagram: Entities: Trading Data

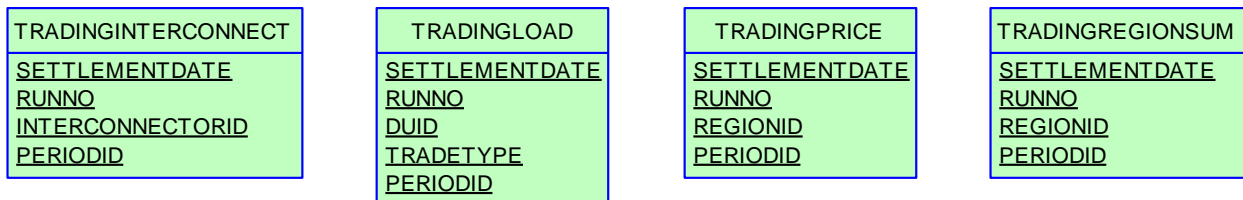

### 33 Package: VOLTAGE\_INSTRUCTIONS

*Name* VOLTAGE\_INSTRUCTIONS  
*Comment* Instructions for MVar Dispatch

#### 33.1 List of tables

Name	Comment
VOLTAGE_INSTRUCTION	Child record for Voltage Instructions (MVar Dispatch)
VOLTAGE_INSTRUCTION_T RK	Parent record for Voltage Instructions (MVar Dispatch). 'SIGNAL' records will have no children; 'INSTRUCTION' records will have children

#### 33.2 Diagram: Entities: Voltage Instructions

