MMS Data Model Report

MMS Data Model v4.29 Oracle

15/08/2019

Contents

- 1 List of packages 20
- 2 Description of the model MMS Data Model v4.29 Oracle 21
- 3 Notes 22
 - 3.1 Visibility 22
- 4 Package: CONFIGURATION 23
 - 4.1 List of tables 23
 - 4.2 Diagram: Entities: Configuration 23
 - 4.3 Table: MMS_DATA_MODEL_AUDIT 24
- 5 Package: ANCILLARY_SERVICES 26
 - 5.1 List of tables 26
 - 5.2 Diagram: Entities: Ancillary Services 27
 - 5.3 Table: CONTRACTAGC 28
 - 5.4 Table: CONTRACTLOADSHED 31
 - 5.5 Table: CONTRACTREACTIVEPOWER 35
 - 5.6 Table: CONTRACTRESTARTSERVICES 39
 - 5.7 Table: CONTRACTRESTARTUNITS 42
- 6 Package: ASOFFER 44
 - 6.1 List of tables 44
 - 6.2 Diagram: Entities: Ancillary Service Contracts 44
 - 6.3 Table: OFFERAGCDATA 45
 - 6.4 Table: OFFERASTRK 48
 - 6.5 Table: OFFERLSHEDDATA 50
 - 6.6 Table: OFFERRESTARTDATA 52
 - 6.7 Table: OFFERRPOWERDATA 54
- 7 Package: BIDS 56
 - 7.1 List of tables 56
 - 7.2 Diagram: Entities: Bids 58
 - 7.3 Table: BIDDAYOFFER 59
 - 7.4 Table: BIDDAYOFFER_D 62

7.5	Table: BIDOFFERFILETRK	65
7.6	Table: BIDPEROFFER.....	68
7.7	Table: BIDPEROFFER_D.....	72
7.8	Table: MNSP_DAYOFFER.....	76
7.9	Table: MNSP_FILETRK.....	79
7.10	Table: MNSP_OFFERTRK.....	81
7.11	Table: MNSP_PEROFFER.....	83
7.12	Table: MTPASA_OFFERDATA.....	86
7.13	Table: MTPASA_OFFERFILETRK.....	88
8	Package: BILLING_CONFIG	90
8.1	List of tables.....	90
8.2	Diagram: Entities: Billing Config	91
8.3	Table: BILLINGCALENDAR	92
8.4	Table: GST_BAS_CLASS	94
8.5	Table: GST_RATE	96
8.6	Table: GST_TRANSACTION_CLASS.....	98
8.7	Table: GST_TRANSACTION_TYPE.....	100
8.8	Table: SECDEPOSIT_INTEREST_RATE	102
8.9	Table: SECDEPOSIT_PROVISION	104
9	Package: BILLING_RUN	106
9.1	List of tables.....	106
9.2	Diagram: Entities: Billing Run.....	111
9.3	Table: BILLING_APC_COMPENSATION	112
9.4	Table: BILLING_APC_RECOVERY	114
9.5	Table: BILLING_CO2E_PUBLICATION.....	116
9.6	Table: BILLING_CO2E_PUBLICATION_TRK	118
9.7	Table: BILLING_DAILY_ENERGY_SUMMARY	120
9.8	Table: BILLING_DIRECTION_RECON_OTHER	122
9.9	Table: BILLING_DIRECTION_RECONCILIATN	125
9.10	Table: BILLING_EFTSHORTFALL_AMOUNT	128
9.11	Table: BILLING_EFTSHORTFALL_DETAIL	130
9.12	Table: BILLING_GST_DETAIL.....	132
9.13	Table: BILLING_GST_SUMMARY	134

9.14	Table: BILLING_MR_PAYMENT	136
9.15	Table: BILLING_MR_RECOVERY	138
9.16	Table: BILLING_MR_SHORTFALL.....	140
9.17	Table: BILLING_MR_SUMMARY	142
9.18	Table: BILLING_NMAS_TST_PAYMENTS.....	144
9.19	Table: BILLING_NMAS_TST_RECOVERY	146
9.20	Table: BILLING_NMAS_TST_RECVRY_RBF.....	149
9.21	Table: BILLING_NMAS_TST_RECVRY_TRK.....	151
9.22	Table: BILLING_RES_TRADER_PAYMENT	153
9.23	Table: BILLING_RES_TRADER_RECOVERY.....	155
9.24	Table: BILLING_SECDEP_INTEREST_PAY	157
9.25	Table: BILLING_SECDEP_INTEREST_RATE	159
9.26	Table: BILLING_SECDEPOSIT_APPLICATION	161
9.27	Table: BILLINGAPCCOMPENSATION.....	163
9.28	Table: BILLINGAPCRECOVERY.....	165
9.29	Table: BILLINGASPAYMENTS.....	167
9.30	Table: BILLINGASRECOVERY.....	170
9.31	Table: BILLINGCPDATA.....	175
9.32	Table: BILLINGDAYTRK	178
9.33	Table: BILLINGFEES	180
9.34	Table: BILLINGFINANCIALADJUSTMENTS	183
9.35	Table: BILLINGGENDATA	186
9.36	Table: BILLINGINTERRESIDUES	189
9.37	Table: BILLINGINTRARESIDUES.....	191
9.38	Table: BILLINGIRAUCSURPLUS.....	193
9.39	Table: BILLINGIRAUCSURPLUSSUM	196
9.40	Table: BILLINGIRFM.....	199
9.41	Table: BILLINGIRNSPSURPLUS	201
9.42	Table: BILLINGIRNSPSURPLUSSUM.....	204
9.43	Table: BILLINGIRPARTSURPLUS.....	207
9.44	Table: BILLINGIRPARTSURPLUSSUM	210
9.45	Table: BILLINGPRIORADJUSTMENTS.....	214
9.46	Table: BILLINGREALLOC	217

9.47	Table: BILLINGREALLOC_DETAIL	219
9.48	Table: BILLINGREGIONEXPORTS	221
9.49	Table: BILLINGREGIONFIGURES	223
9.50	Table: BILLINGREGIONIMPORTS	226
9.51	Table: BILLINGRUNTRK	228
9.52	Table: BILLINGSMELTERREDUCTION	231
9.53	Table: BILLWHITEHOLE	234
10	Package: DEMAND_FORECASTS	236
10.1	List of tables.....	236
10.2	Diagram: Entities: Demand Forecasts	238
10.3	Table: DEMANDOPERATIONALACTUAL	239
10.4	Table: DEMANDOPERATIONALFORECAST	241
10.5	Table: INTERMITTENT_CLUSTER_AVAIL	243
10.6	Table: INTERMITTENT_CLUSTER_AVAIL_DAY	245
10.7	Table: INTERMITTENT_DS_PRED	246
10.8	Table: INTERMITTENT_DS_RUN	248
10.9	Table: INTERMITTENT_GEN_FCST	251
10.10	Table: INTERMITTENT_GEN_FCST_DATA	253
10.11	Table: INTERMITTENT_GEN_LIMIT	255
10.12	Table: INTERMITTENT_GEN_LIMIT_DAY	257
10.13	Table: INTERMITTENT_P5_PRED	259
10.14	Table: INTERMITTENT_P5_RUN	261
10.15	Table: MTPASA_INTERMITTENT_AVAIL	263
10.16	Table: MTPASA_INTERMITTENT_LIMIT	265
10.17	Table: PERDEMAND	267
10.18	Table: RESDEMANDTRK	270
10.19	Table: ROOFTOP_PV_ACTUAL	272
10.20	Table: ROOFTOP_PV_FORECAST	274
11	Package: DISPATCH	276
11.1	List of tables.....	276
11.2	Diagram: Entities: Dispatch.....	280
11.3	Table: CONSTRAINTRELAXATION_OCD	281
11.4	Table: DISPATCH_CONSTRAINT_FCAS_OCD	283

11.5	Table: DISPATCH_FCAS_REQ	285
11.6	Table: DISPATCH_INTERCONNECTION	288
11.7	Table: DISPATCH_LOCAL_PRICE	290
11.8	Table: DISPATCH_MNSPBIDTRK	292
11.9	Table: DISPATCH_MR_SCHEDULE_TRK	294
11.10	Table: DISPATCH_PRICE_REVISION	296
11.11	Table: DISPATCH_UNIT_CONFORMANCE	298
11.12	Table: DISPATCH_UNIT_SCADA	301
11.13	Table: DISPATCHBLOCKEDCONSTRAINT	303
11.14	Table: DISPATCHCASESOLUTION	304
11.15	Table: DISPATCHCONSTRAINT	308
11.16	Table: DISPATCHINTERCONNECTORRES	311
11.17	Table: DISPATCHLOAD	315
11.18	Table: DISPATCHOFFERTRK	321
11.19	Table: DISPATCHPRICE	323
11.20	Table: DISPATCHREGIONSUM	329
11.21	Table: INTERMITTENT_FORECAST_TRK	340
11.22	Table: NEGATIVE_RESIDUE	342
12	Package: FORCE_MAJEURE	345
12.1	List of tables	345
12.2	Diagram: Entities: Force Majeure	346
12.3	Table: APEVENT	347
12.4	Table: APEVENTREGION	349
12.5	Table: IRFMAMOUNT	351
12.6	Table: IRFMEVENTS	353
12.7	Table: MARKET_SUSPEND_REGIME_SUM	355
12.8	Table: MARKET_SUSPEND_REGION_SUM	357
12.9	Table: MARKET_SUSPEND_SCHEDULE	359
12.10	Table: MARKET_SUSPEND_SCHEDULE_TRK	362
12.11	Table: OVERRIDERRP	364
12.12	Table: REGIONAPC	366
12.13	Table: REGIONAPCINTERVALS	368

13	Package: GD_INSTRUCT	370
13.1	List of tables.....	370
13.2	Diagram: Entities: GD Instruct	371
13.3	Table: GDINSTRUCT.....	372
13.4	Table: INSTRUCTIONSUBTYPE	375
13.5	Table: INSTRUCTIONTYPE	377
14	Package: GENERIC_CONSTRAINT	379
14.1	List of tables.....	379
14.2	Diagram: Entities: Generic Constraints	381
14.3	Table: EMSMASTER.....	382
14.4	Table: GENCONDATA	384
14.5	Table: GENCONSET.....	388
14.6	Table: GENCONSETINVOKE.....	390
14.7	Table: GENCONSETTRK	393
14.8	Table: GENERICCONSTRAINTRHS	395
14.9	Table: GENERICEQUATIONDESC	398
14.10	Table: GENERICEQUATIONRHS.....	400
14.11	Table: SPDCONNECTIONPOINTCONSTRAINT	403
14.12	Table: SPDINTERCONNECTORCONSTRAINT	405
14.13	Table: SPDREGIONCONSTRAINT.....	407
15	Package: IRAUCTION.....	409
15.1	List of tables.....	409
15.2	Diagram: Entities: IRAuction.....	413
15.3	Table: AUCTION	414
15.4	Table: AUCTION_CALENDAR.....	416
15.5	Table: AUCTION_IC_ALLOCATIONS.....	418
15.6	Table: AUCTION_REVENUE_ESTIMATE	421
15.7	Table: AUCTION_REVENUE_TRACK.....	424
15.8	Table: AUCTION_RP_ESTIMATE	426
15.9	Table: AUCTION_TRANCHE	428
15.10	Table: RESIDUE_BID_TRK.....	430
15.11	Table: RESIDUE_CON_DATA	432
15.12	Table: RESIDUE_CON_ESTIMATES_TRK.....	434

15.13	Table: RESIDUE_CON_FUNDS	436
15.14	Table: RESIDUE_CONTRACTS.....	438
15.15	Table: RESIDUE_FUNDS_BID	441
15.16	Table: RESIDUE_PRICE_BID	443
15.17	Table: RESIDUE_PRICE_FUNDS_BID.....	445
15.18	Table: RESIDUE_PUBLIC_DATA.....	447
15.19	Table: RESIDUE_TRK.....	449
15.20	Table: RESIDUECONTRACTPAYMENTS.....	451
15.21	Table: RESIDUEFILETRK.....	453
15.22	Table: SRA_CASH_SECURITY.....	455
15.23	Table: SRA_FINANCIAL_AUC_MARDETAIL.....	457
15.24	Table: SRA_FINANCIAL_AUC_MARGIN	459
15.25	Table: SRA_FINANCIAL_AUC_RECEIPTS	461
15.26	Table: SRA_FINANCIAL_AUCPAY_DETAIL	463
15.27	Table: SRA_FINANCIAL_AUCPAY_SUM	465
15.28	Table: SRA_FINANCIAL_RUNTRK.....	467
15.29	Table: SRA_OFFER_PRODUCT	469
15.30	Table: SRA_OFFER_PROFILE	471
15.31	Table: SRA_PRUDENTIAL_CASH_SECURITY	473
15.32	Table: SRA_PRUDENTIAL_COMP_POSITION.....	475
15.33	Table: SRA_PRUDENTIAL_EXPOSURE	477
15.34	Table: SRA_PRUDENTIAL_RUN.....	480
15.35	Table: VALUATIONID.....	481
16	Package: MARKET_CONFIG	483
16.1	List of tables.....	483
16.2	Diagram: Entities: Market Standing Data	485
16.3	Table: BIDTYPES	486
16.4	Table: BIDTYPESTRK.....	488
16.5	Table: INTERCONNECTOR.....	490
16.6	Table: INTERCONNECTORALLOC.....	492
16.7	Table: INTERCONNECTORCONSTRAINT.....	494
16.8	Table: INTRAREGIONALLOC	497
16.9	Table: LOSSFACTORMODEL	499

16.10	Table: LOSSMODEL.....	501
16.11	Table: MARKET_PRICE_THRESHOLDS.....	503
16.12	Table: REGION	505
16.13	Table: REGIONSTANDINGDATA.....	507
16.14	Table: TRANSMISSIONLOSSFACTOR.....	509
17	Package: MARKET_NOTICE.....	511
17.1	List of tables.....	511
17.2	Diagram: Entities: Market Notices.....	511
17.3	Table: MARKETNOTICEDATA	512
17.4	Table: MARKETNOTICETYPE	514
17.5	Table: PARTICIPANTNOTICETRK	516
18	Package: METER_DATA.....	518
18.1	List of tables.....	518
18.2	Diagram: Entities: Meter Data	519
18.3	Table: METERDATA_AGGREGATE_READS.....	520
18.4	Table: METERDATA_INDIVIDUAL_READS.....	523
18.5	Table: METERDATA_INTERCONNECTOR	525
18.6	Table: METERDATA_TRK.....	527
19	Package: MREVENT.....	529
19.1	List of tables.....	529
19.2	Diagram: Entities: MR Events	530
19.3	Table: MR_DAYOFFER_STACK.....	531
19.4	Table: MR_EVENT	534
19.5	Table: MR_EVENT_SCHEDULE	536
19.6	Table: MR_PEROFFER_STACK	538
20	Package: MTPASA	541
20.1	List of tables.....	541
20.2	Diagram: Entities: MT PASA	542
20.3	Table: MTPASA_CASERESULT.....	543
20.4	Table: MTPASA_CONSTRAINTRESULT	545
20.5	Table: MTPASA_CONSTRAINTSUMMARY.....	548
20.6	Table: MTPASA_INTERCONNECTORRESULT	550
20.7	Table: MTPASA_LOLRESULT	553

20.8	Table: MTPASA_REGIONAVAIL_TRK	555
20.9	Table: MTPASA_REGIONAVAILABILITY	556
20.10	Table: MTPASA_REGIONITERATION	558
20.11	Table: MTPASA_REGIONRESULT	560
20.12	Table: MTPASA_REGIONSUMMARY	564
21	Package: P5MIN.....	568
21.1	List of tables.....	568
21.2	Diagram: Entities: P5MIN	570
21.3	Table: P5MIN_BLOCKEDCONSTRAINT.....	571
21.4	Table: P5MIN_CASESOLUTION.....	572
21.5	Table: P5MIN_CONSTRAINTSOLUTION	575
21.6	Table: P5MIN_INTERCONNECTORSOLN.....	578
21.7	Table: P5MIN_LOCAL_PRICE.....	582
21.8	Table: P5MIN_REGIONSOLUTION	584
21.9	Table: P5MIN_UNITSOLUTION	594
22	Package: PARTICIPANT_REGISTRATION	598
22.1	List of tables.....	598
22.2	Diagram: Entities: Participant Registration.....	601
22.3	Table: BIDDUIDDETAILS	602
22.4	Table: BIDDUIDDETAILSTRK.....	605
22.5	Table: DISPATCHABLEUNIT	607
22.6	Table: DUALLOC	609
22.7	Table: DUDETAIL	611
22.8	Table: DUDETAILSUMMARY	614
22.9	Table: GENMETER.....	617
22.10	Table: GENUNITS	620
22.11	Table: GENUNITS_UNIT	623
22.12	Table: MNSP_INTERCONNECTOR	625
22.13	Table: MNSP_PARTICIPANT	628
22.14	Table: PARTICIPANT	630
22.15	Table: PARTICIPANTACCOUNT	632
22.16	Table: PARTICIPANTCATEGORY	634
22.17	Table: PARTICIPANTCATEGORYALLOC	636

22.18	Table: PARTICIPANTCLASS.....	638
22.19	Table: PARTICIPANTCREDITDETAIL.....	640
22.20	Table: STADUALLOC.....	642
22.21	Table: STATION.....	644
22.22	Table: STATIONOPERATINGSTATUS.....	646
22.23	Table: STATIONOWNER.....	648
22.24	Table: STATIONOWNERTRK.....	650
23	Package: PRE_DISPATCH.....	652
23.1	List of tables.....	653
23.2	Diagram: Entities: Predispatch.....	656
23.3	Table: PREDISPATCH_FCAS_REQ.....	657
23.4	Table: PREDISPATCH_LOCAL_PRICE.....	660
23.5	Table: PREDISPATCH_MNSPBIDTRK.....	662
23.6	Table: PREDISPATCHBLOCKEDCONSTRAINT.....	664
23.7	Table: PREDISPATCHCASESOLUTION.....	665
23.8	Table: PREDISPATCHCONSTRAINT.....	668
23.9	Table: PREDISPATCHINTERCONNECTORRES.....	671
23.10	Table: PREDISPATCHINTERSENSITIVITIES.....	675
23.11	Table: PREDISPATCHLOAD.....	680
23.12	Table: PREDISPATCHOFFERTRK.....	686
23.13	Table: PREDISPATCHPRICE.....	688
23.14	Table: PREDISPATCHPRICESENSITIVITIES.....	692
23.15	Table: PREDISPATCHREGIONSUM.....	698
23.16	Table: PREDISPATCHSCENARIODEMAND.....	709
23.17	Table: PREDISPATCHSCENARIODEMANDTRK.....	710
24	Package: RESERVE_DATA.....	712
24.1	List of tables.....	712
24.2	Diagram: Entities: Reserve Data.....	713
24.3	Table: MTPASA_RESERVELIMIT.....	714
24.4	Table: MTPASA_RESERVELIMIT_REGION.....	716
24.5	Table: MTPASA_RESERVELIMIT_SET.....	718
24.6	Table: RESERVE.....	720

25	Package: SETTLEMENT_CONFIG	723
25.1	List of tables.....	723
25.2	Diagram: Entities: Settlement Config.....	725
25.3	Table: ANCILLARY_RECOVERY_SPLIT	726
25.4	Table: MARKET_FEE_CAT_EXCL.....	728
25.5	Table: MARKET_FEE_CAT_EXCL_TRK	730
25.6	Table: MARKET_FEE_EXCLUSION	732
25.7	Table: MARKET_FEE_EXCLUSIONTRK.....	734
25.8	Table: MARKETFEE.....	736
25.9	Table: MARKETFEEDATA	738
25.10	Table: MARKETFEETRK.....	740
25.11	Table: PARTICIPANT_BANDFEE_ALLOC.....	742
25.12	Table: REALLOCATION	744
25.13	Table: REALLOCATIONINTERVAL.....	747
25.14	Table: SETCFG_PARTICIPANT_MPF	749
25.15	Table: SETCFG_PARTICIPANT_MPFTRK.....	751
26	Package: SETTLEMENT_DATA	753
26.1	List of tables.....	753
26.2	Diagram: Entities: Settlement Data.....	758
26.3	Table: DAYTRACK.....	759
26.4	Table: SET_APC_COMPENSATION	761
26.5	Table: SET_APC_RECOVERY	763
26.6	Table: SET_ANCILLARY_SUMMARY	765
26.7	Table: SET_FCAS_PAYMENT	767
26.8	Table: SET_FCAS_RECOVERY	769
26.9	Table: SET_FCAS_REGULATION_TRK.....	773
26.10	Table: SET_MR_PAYMENT.....	775
26.11	Table: SET_MR_RECOVERY	777
26.12	Table: SET_NMAS_RECOVERY	779
26.13	Table: SET_NMAS_RECOVERY_RBF.....	782
26.14	Table: SET_RUN_PARAMETER	784
26.15	Table: SETAGCPAYMENT	786
26.16	Table: SETAGCRECOVERY.....	789

26.17	Table: SETCPDATA	791
26.18	Table: SETCPDATAREGION	794
26.19	Table: SETFCASCOMP	796
26.20	Table: SETFCASREGIONRECOVERY	799
26.21	Table: SETGENDATA	801
26.22	Table: SETGENDATAREGION	805
26.23	Table: SETINTERVENTION	807
26.24	Table: SETINTERVENTIONRECOVERY	809
26.25	Table: SETINTRAREGIONRESIDUES	811
26.26	Table: SETIRAUCSURPLUS	813
26.27	Table: SETIRFMRECOVERY	816
26.28	Table: SETIRNSPSURPLUS	818
26.29	Table: SETIRPARTSURPLUS	821
26.30	Table: SETIRSURPLUS	824
26.31	Table: SETLSHEDPAYMENT	827
26.32	Table: SETLSHEDRECOVERY	830
26.33	Table: SETLUNLOADRECOVERY	833
26.34	Table: SETLUNLOADPAYMENT	836
26.35	Table: SETLUNLOADRECOVERY	839
26.36	Table: SETMARKETFEEES	842
26.37	Table: SETREALLOCATIONS	844
26.38	Table: SETRESERVERECOVERY	846
26.39	Table: SETRESTARTPAYMENT	848
26.40	Table: SETRESTARTRECOVERY	851
26.41	Table: SETRPOWERPAYMENT	854
26.42	Table: SETRPOWERRECOVERY	857
26.43	Table: SETSMALLGENDATA	860
26.44	Table: SETVICBOUNDARYENERGY	862
26.45	Table: SETVICENERGYFIGURES	864
26.46	Table: SETVICENERGYFLOW	866
27	Package: STPASA_SOLUTION	868
27.1	List of tables.....	868
27.2	Diagram: Entities: ST PASA Solution	869

27.3	Table: STPASA_CASESOLUTION.....	870
27.4	Table: STPASA_CONSTRAINTSOLUTION.....	874
27.5	Table: STPASA_INTERCONNECTORSOLN.....	876
27.6	Table: STPASA_REGIONSOLUTION.....	879
28	Package: TRADING_DATA.....	885
28.1	List of tables.....	885
28.2	Diagram: Entities: Trading Data.....	885
28.3	Table: TRADINGINTERCONNECT.....	886
28.4	Table: TRADINGLOAD.....	888
28.5	Table: TRADINGPRICE.....	891
28.6	Table: TRADINGREGIONSUM.....	895
29	Package: HISTORICAL TABLES.....	903
29.1	List of tables.....	903
29.2	Diagram: Entities: Historical Tables.....	913
29.3	Table: APCCOMP.....	914
29.4	Table: APCCOMPAMOUNT.....	916
29.5	Table: APCCOMPAMOUNTTRK.....	918
29.6	Table: BILLADJUSTMENTS.....	920
29.7	Table: BILLING_CSP_DEROGATION_AMOUNT.....	923
29.8	Table: BILLINGCPSUM.....	925
29.9	Table: BILLINGCUSTEXCESSGEN.....	927
29.10	Table: BILLINGEXCESSGEN.....	929
29.11	Table: BILLINGINTERVENTION.....	932
29.12	Table: BILLINGINTERVENTIONREGION.....	934
29.13	Table: BILLINGRESERVERECOVERY.....	936
29.14	Table: BILLINGRESERVEREGIONRECOVERY.....	938
29.15	Table: BILLINGRESERVETRADER.....	940
29.16	Table: BILLINGRESERVETRADERREGION.....	942
29.17	Table: BILLINTERVENTIONRECOVERY.....	944
29.18	Table: BILLINTERVENTIONREGIONRECOVERY.....	946
29.19	Table: BILLSMELTERRATE.....	948
29.20	Table: CONNECTIONPOINT.....	950
29.21	Table: CONNECTIONPOINTDETAILS.....	952

29.22	Table: CONNECTIONPOINTOPERATINGSTA.....	956
29.23	Table: CONTRACTGOVERNOR.....	958
29.24	Table: CONTRACTRESERVEFLAG.....	963
29.25	Table: CONTRACTRESERVETHRESHOLD.....	965
29.26	Table: CONTRACTRESERVETRADER.....	967
29.27	Table: CONTRACTUNITLOADING.....	969
29.28	Table: CONTRACTUNITUNLOADING.....	971
29.29	Table: DAYOFFER.....	973
29.30	Table: DAYOFFER_D.....	976
29.31	Table: DEFAULTDAYOFFER.....	979
29.32	Table: DEFAULTOFFERTRK.....	982
29.33	Table: DEFAULTPEROFFER.....	984
29.34	Table: DELTAMW.....	987
29.35	Table: DISPATCHBIDTRK.....	990
29.36	Table: DISPATCHCASE_OCD.....	992
29.37	Table: DISPATCHCASESOLUTION_BNC.....	994
29.38	Table: DISPATCHLOAD_BNC.....	998
29.39	Table: DISPATCHTRK.....	1002
29.40	Table: FORCEMAJEURE.....	1004
29.41	Table: FORCEMAJEUREREGION.....	1006
29.42	Table: GENUNITMTRINPERIOD.....	1008
29.43	Table: INTCONTRACT.....	1011
29.44	Table: INTCONTRACTAMOUNT.....	1013
29.45	Table: INTCONTRACTAMOUNTTRK.....	1015
29.46	Table: INTERCONNMWFLOW.....	1017
29.47	Table: MARKETSUSPENSION.....	1019
29.48	Table: MARKETSUSREGION.....	1021
29.49	Table: MAS_CP_CHANGE.....	1023
29.50	Table: MAS_CP_MASTER.....	1028
29.51	Table: METERDATA.....	1032
29.52	Table: METERDATA_GEN_DUID.....	1035
29.53	Table: METERDATATRK.....	1037
29.54	Table: MTPASA_CASE_SET.....	1040

29.55	Table: MTPASA_CASESOLUTION	1042
29.56	Table: MTPASA_CONSTRAINTSOLUTION.....	1046
29.57	Table: MTPASA_INTERCONNECTORSOLUTION	1049
29.58	Table: MTPASA_REGIONSOLUTION.....	1053
29.59	Table: MTPASA_RESERVELIMITSOLUTION	1059
29.60	Table: MTPASACONSTRAINTSOLUTION_D	1061
29.61	Table: MTPASAINTERCONNECTORSOLUTION_D.....	1063
29.62	Table: MTPASAREGIONSOLUTION_D	1065
29.63	Table: OARTRACK.....	1067
29.64	Table: OFFERFILETRK.....	1069
29.65	Table: OFFERGOVDATA	1071
29.66	Table: OFFERUNLOADINGDATA	1073
29.67	Table: OFFERUNLOADINGDATA	1075
29.68	Table: PASACASESOLUTION	1077
29.69	Table: PASACONSTRAINTSOLUTION.....	1079
29.70	Table: PASAINTERCONNECTORSOLUTION	1081
29.71	Table: PASAREGIONSOLUTION.....	1083
29.72	Table: PEROFFER.....	1086
29.73	Table: PEROFFER_D.....	1089
29.74	Table: PREDISPATCHBIDTRK.....	1092
29.75	Table: REALLOCATIONDETAILS.....	1095
29.76	Table: REALLOCATIONINTERVALS	1097
29.77	Table: REALLOCATIONS.....	1099
29.78	Table: REGIONFCASRELAXATION_OCD	1101
29.79	Table: SET_CSP_DEROGATION_AMOUNT	1103
29.80	Table: SET_CSP_SUPPORTDATA_CONSTRAINT	1105
29.81	Table: SET_CSP_SUPPORTDATA_ENERGYDIFF	1108
29.82	Table: SET_CSP_SUPPORTDATA_SUBPRICE	1111
29.83	Table: SETAPCCOMPENSATION	1114
29.84	Table: SETAPCRECOVERY	1116
29.85	Table: SETFCASRECOVERY	1118
29.86	Table: SETGOVPAYMENT.....	1121
29.87	Table: SETGOVRECOVERY	1125

29.88	Table: SETLULOADPAYMENT	1128
29.89	Table: SETRESERVETRADER.....	1131
29.90	Table: STPASA_SYSTEMSOLUTION	1133
29.91	Table: STPASA_UNITSOLUTION	1136
30	Package: PDPASA.....	1139
30.1	List of tables.....	1139
30.2	Diagram: Entities: PD PASA.....	1139
30.3	Table: PDPASA_CASESOLUTION.....	1141
30.4	Table: PDPASA_REGIONSOLUTION	1145
31	Package: PRUDENTIALS.....	1152
31.1	List of tables.....	1152
31.2	Diagram: Entities:Prudentials.....	1152
31.3	Table: PRUDENTIALCOMPANYPOSITION.....	1154
31.4	Table: PRUDENTIALRUNTRK.....	1157
32	Package: MCC_DISPATCH.....	1159
32.1	List of tables.....	1159
32.2	Diagram: Entities: MCC_Dispatch.....	1159
32.3	Table: MCC_CASESOLUTION.....	1160
32.4	Table: MCC_CONSTRAINTSOLUTION	1161
33	Package: NETWORK	1162
33.1	List of tables.....	1162
33.2	Diagram: Entities: NETWORK.....	1164
33.3	Table: NETWORK_EQUIPMENTDETAIL	1165
33.4	Table: NETWORK_OUTAGECONSTRAINTSET	1168
33.5	Table: NETWORK_OUTAGEDetail.....	1169
33.6	Table: NETWORK_OUTAGESTATUSCODE	1173
33.7	Table: NETWORK_RATING.....	1174
33.8	Table: NETWORK_REALTIMERATING.....	1177
33.9	Table: NETWORK_STATICRATING.....	1179
33.10	Table: NETWORK_SUBSTATIONDETAIL	1182
34	Package: VOLTAGE_INSTRUCTIONS	1184
34.1	List of tables.....	1184
34.2	Diagram: Entities: Voltage Instructions	1184

- 34.3 Table: VOLTAGE_INSTRUCTION..... 1186
- 34.4 Table: VOLTAGE_INSTRUCTION_TRK..... 1189
- 35 List of tables.....1191

Disclaimer

This document is made available to you on the following basis:

- (a) Purpose - This document is provided by the Australian Energy Market Operator Limited (AEMO) to you for information purposes only. You are not permitted to commercialise it or any information contained in it.

- (b) No Reliance or warranty - This document may be subsequently amended. AEMO does not warrant or represent that the data or information in this document is accurate, reliable, complete or current or that it is suitable for particular purposes. You should verify and check the accuracy, completeness, reliability and suitability of this document for any use to which you intend to put it and seek independent expert advice before using it, or any information contained in it.

- (c) Limitation of liability - To the extent permitted by law, AEMO and its advisers, consultants and other contributors to this document (or their respective associated companies, businesses, partners, directors, officers or employees) shall not be liable for any errors, omissions, defects or misrepresentations in the information contained in this document, or for any loss or damage suffered by persons who use or rely on such information (including by reason of negligence, negligent misstatement or otherwise). If any law prohibits the exclusion of such liability, AEMO's liability is limited, at AEMO's option, to the re-supply of the information, provided that this limitation is permitted by law and is fair and reasonable.

© 2010 - All rights reserved.

1 List of packages

Name	Code	Use Parent Namespace
CONFIGURATION	CONFIGURATION	X
ANCILLARY_SERVICES	ANCILLARY_SERVICES	X
ASOFFER	ASOFFER	X
BIDS	BIDS	X
BILLING_CONFIG	BILLING_CONFIG	X
BILLING_RUN	BILLING_RUN	X
DEMAND_FORECASTS	DEMAND_FORECASTS	X
DISPATCH	DISPATCH	X
FORCE_MAJEURE	FORCE_MAJEURE	X
GD_INSTRUCT	GD_INSTRUCT	X
GENERIC_CONSTRAINT	GENERIC_CONSTRAINT	X
IRAUCTION	IRAUCTION	X
MARKET_CONFIG	MARKET_CONFIG	X
MARKET_NOTICE	MARKET_NOTICE	X
METER_DATA	METER_DATA	X
MREVENT	MREVENT	X
MTPASA	MTPASA	X
P5MIN	P5MIN	X
PARTICIPANT_REGISTRATION	PARTICIPANT_REGISTRATION	X

PRE_DISPATCH	PRE_DISPATCH	X
RESERVE_DATA	RESERVE_DATA	X
SETTLEMENT_CONFIG	SETTLEMENT_CONFIG	X
SETTLEMENT_DATA	SETTLEMENT_DATA	X
STPASA_SOLUTION	STPASA_SOLUTION	X
TRADING_DATA	TRADING_DATA	X
HISTORICAL TABLES	HISTORICAL_TABLES	X
PDPASA	PDPASA	X
PRUDENTIALS	PRUDENTIALS	X
MCC_DISPATCH	MCC_DISPATCH	X
NETWORK	NETWORK	X
VOLTAGE_INSTRUCTIONS	VOLTAGE_INSTRUCTIONS	X

2 Description of the model MMS Data Model v4.29 Oracle

Background

The MMS Data Model is the definition of the interface to participants of data published by AEMO from the NEM system. A database conforming to the MMS Data Model can contain a local copy of all current participant-specific data recorded in the main NEM production database. The target databases have been called such names as the Participant Database, the Participant InfoServer and the Replica Database.

The MMS Data Model includes database tables, indexes and primary keys. The model is currently exposed as a physical model, so is different in presentation for each RDBMS. However, the same logical model underlies all the physical models published by AEMO.

The MMS Data Model is the target model for products transferring data from AEMO to each participant. Current product supplied by AEMO for data transfer is Participant Data Replication (PDR), with some support for the superseded Parser.

Compatibility of the transfer products with the MMS Data Model is the responsibility of those products and their configuration. AEMO's intention is to supply the data transfer products pre-configured to deliver data consistent with the MMS Data Model, noting differences where they occur (e.g. for historical reasons).

Entity Diagrams

The entity diagrams show the key columns. Relationships have now been included in many cases.

Note:

The National Electricity Market registration classification of Yarwun Power Station Unit 1 (dispatchable unit ID: YARWUN_1) is market non-scheduled generating unit. However, it is a condition of the registration of this unit that the Registered Participant complies with some of the obligations of a Scheduled Generator. This unit is dispatched as a scheduled generating unit with respect to its dispatch offers, targets and generation outputs. Accordingly, information about YARWUN_1 is reported as scheduled generating unit information.

3 Notes

Each table description has a Note providing some information relevant to the table.

3.1 Visibility

Visibility refers to the nature of confidentiality of data in the table. Each table has one of the following entries, each described here.

Private: meaning the data is confidential to the Participant (e.g. BILLINGFEES).

Public: meaning all Participants have access to the data (e.g. DISPATCHPRICE).

Private, Public Next-Day: meaning the data is confidential until available for public release at beginning of next day (i.e. 4am) (e.g. BIDDAYOFFER).

Private & Public: meaning some items are private and some are public (e.g. MARKETNOTICES).

4 Package: CONFIGURATION

Name CONFIGURATION
Comment MMS Data Model Configuration Management and Control

4.1 List of tables

Name	Comment
MMS_DATA_MODEL_AUDIT	MMS_DATA_MODEL_AUDIT shows the audit trail of scripts applied to this installation of MMS Data Model. Participants should ensure that if a database is cloned the content of this table is copied to the target database.

4.2 Diagram: Entities: Configuration

MMS_DATA_MODEL_AUDIT		
<u>INSTALLATION_DATE</u>	<u>DATE</u>	<pk>
<u>MMSDM_VERSION</u>	<u>VARCHAR2(20)</u>	<pk>
<u>INSTALL_TYPE</u>	<u>VARCHAR2(10)</u>	<pk>
SCRIPT_VERSION	VARCHAR2(20)	
NEM_CHANGE_NOTICE	VARCHAR2(20)	
PROJECT_TITLE	VARCHAR2(200)	
USERNAME	VARCHAR2(40)	
STATUS	VARCHAR2(10)	

4.3 Table: MMS_DATA_MODEL_AUDIT

4.3.1 MMS_DATA_MODEL_AUDIT

Name	MMS_DATA_MODEL_AUDIT
Comment	MMS_DATA_MODEL_AUDIT shows the audit trail of scripts applied to this installation of MMS Data Model. Participants should ensure that if a database is cloned the content of this table is copied to the target database.

4.3.2 Description

Source

Delivered within scripts comprising install or updates to the MMS Data Model schema.

Volume

1 record is inserted per release of MMS Data Model managed product

4.3.3 Primary Key Columns

Name
INSTALL_TYPE
INSTALLATION_DATE
MMSDM_VERSION

4.3.4 Content

Name	Data Type	Mandatory	Comment
INSTALLATION_DATE	DATE	X	The date in which the changes to the MMS Data Model were installed
MMSDM_VERSION	VARCHAR2(20)	X	The version of MMS Data Model

)		after the script has been applied
INSTALL_TYPE	VARCHAR2(10)	X	The type of the patch applied. Valid entries are: FULL, UPGRADE, DML
SCRIPT_VERSION	VARCHAR2(20)		The version of the patch set to the MMS Data Model
NEM_CHANGE_NOTICE	VARCHAR2(20)		The NEM Change notice for which this MMS Data Model applies
PROJECT_TITLE	VARCHAR2(20 0)		The name of the business project for which these changes to the MMS Data Model apply
USERNAME	VARCHAR2(40)		The USER applying this script
STATUS	VARCHAR2(10)		The status of the upgrade. Valid entries are STARTED, FAILED, SUCCESS

5 Package: ANCILLARY_SERVICES

<i>Name</i>	ANCILLARY_SERVICES
<i>Comment</i>	Ancillary Service Contract Data

5.1 List of tables

Name	Comment
CONTRACTAGC	CONTRACTAGC shows Automatic Generation Control (AGC) contract details for each dispatchable unit. There is a separate contract for each unit.
CONTRACTLOADSHED	CONTRACTLOADSHED shows Governor contract details used in the settlement and dispatch of this service. Note: services are dispatched as 6 and 60 raise Frequency Control Ancillary Services (FCAS). Mandatory requirements and breakpoint details are not used for load shed.
CONTRACTREACTIVEPOWER	CONTRACTREACTIVEPOWER shows Reactive Power contract details used in the settlement and dispatch of this service.
CONTRACTRESTARTSERVICES	CONTRACTRESTARTSERVICES shows Restart Services contract details used in the settlement and dispatch of this service.
CONTRACTRESTARTUNITS	CONTRACTRESTARTUNITS shows Restart units provided under a system restart contract. A service can have multiple units.

5.2 Diagram: Entities: Ancillary Services

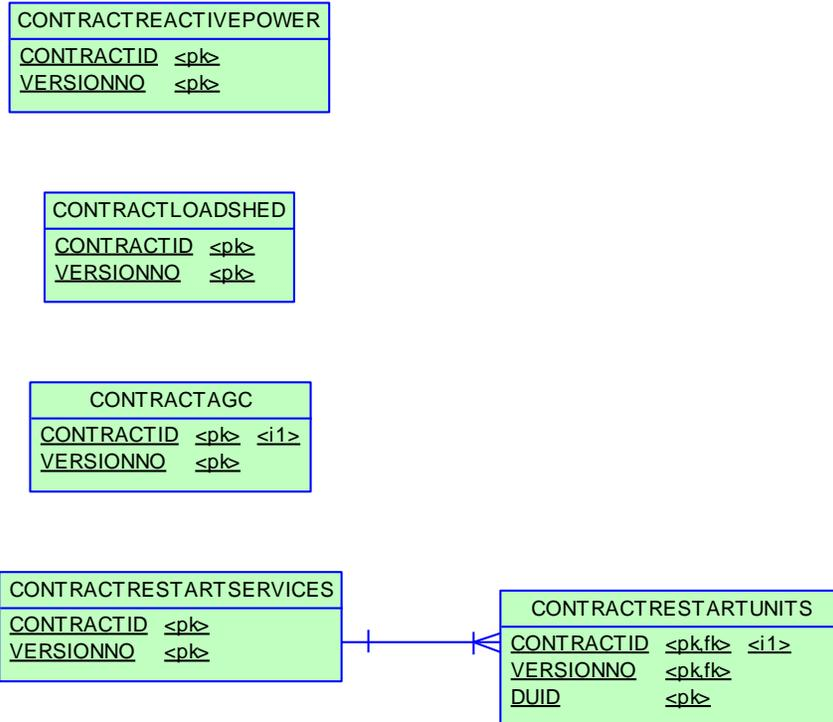

5.3 Table: CONTRACTAGC

5.3.1 CONTRACTAGC

Name	CONTRACTAGC
Comment	CONTRACTAGC shows Automatic Generation Control (AGC) contract details for each dispatchable unit. There is a separate contract for each unit.

5.3.2 Description

CONTRACTAGC data is confidential to the relevant participant.

Source

CONTRACTAGC updates only where there is a contract variation.

5.3.3 Notes

Name	Comment	Value
Visibility	Data in this table is:	Private

5.3.4 Primary Key Columns

- Name
- CONTRACTID
- VERSIONNO

5.3.5 Index Columns

- Name
- LASTCHANGED

5.3.6 Index Columns

Name

PARTICIPANTID

CONTRACTID

5.3.7 Content

Name	Data Type	Mandatory	Comment
CONTRACTID	VARCHAR2(10)	X	Contract Identifier
VERSIONNO	NUMBER(3,0)	X	Contract Version No
STARTDATE	DATE		Starting Date of Contract
ENDDATE	DATE		End date of contract
PARTICIPANTID	VARCHAR2(10)		Unique participant identifier
DUID	VARCHAR2(10)		Dispatchable Unit ID
CRR	NUMBER(4,0)		Control Range Raise 5 Min MW
CRL	NUMBER(4,0)		Control Range Lower 5 Min MW
RLPRICE	NUMBER(10,2)		Enabling Price in \$
CCPRICE	NUMBER(10,2)		Compensation Cap in \$
BS	NUMBER(10,2)		Block Size
AUTHORISED BY	VARCHAR2(15)		User Name
AUTHORISED DATE	DATE		Date Contract was Authorised

LASTCHANGED	DATE		Last date and time record changed
-------------	------	--	-----------------------------------

5.4 Table: CONTRACTLOADSHED

5.4.1 CONTRACTLOADSHED

Name	CONTRACTLOADSHED
Comment	CONTRACTLOADSHED shows Governor contract details used in the settlement and dispatch of this service. Note: services are dispatched as 6 and 60 raise Frequency Control Ancillary Services (FCAS). Mandatory requirements and breakpoint details are not used for load shed.

5.4.2 Description

CONTRACTLOADSHED data is confidential to the relevant participant.

Source

CONTRACTLOADSHED updates only where there is a contract variation.

5.4.3 Notes

Name	Comment	Value
Visibility	Data in this table is:	Private

5.4.4 Primary Key Columns

- Name
- CONTRACTID
- VERSIONNO

5.4.5 Index Columns

- Name
- LASTCHANGED

5.4.6 Index Columns

Name

PARTICIPANTID

5.4.7 Content

Name	Data Type	Mandatory	Comment
CONTRACTID	VARCHAR2(10)	X	Contract Identifier
VERSIONNO	NUMBER(3,0)	X	Contract Version No.
STARTDATE	DATE		Starting Date of Contract
ENDDATE	DATE		Termination Date of Contract
PARTICIPANTID	VARCHAR2(10)		Unique participant identifier
DUID	VARCHAR2(10)		Dispatchable Unit ID
LSEPRICE	NUMBER(6,2)		The load shed enabling price for this contract
MCPPRICE	NUMBER(12,2)		Minimum Compensation price
TENDEREDPRICE	NUMBER(6,2)		Price Tendered for Compensation per Trading interval - Not used since 13/12/1998
LSCR	NUMBER(6,2)		Load Shed Control Range
ILSCALINGFACTOR	NUMBER(15,5)		SPD scaling factor for load shed vs dispatched, (1 = dispatched)
LOWER60SECBREAKPOINT	NUMBER(9,6)		Not used

LOWER60SECMAX	NUMBER(9,6)		Not used
LOWER6SECBREAKPOINT	NUMBER(9,6)		Not used
LOWER6SECMAX	NUMBER(9,6)		Not used
RAISE60SECBREAKPOINT	NUMBER(9,6)		Not used
RAISE60SECCAPACITY	NUMBER(9,6)		Not used
RAISE60SECMAX	NUMBER(9,6)		Maximum 60 second raise
RAISE6SECBREAKPOINT	NUMBER(9,6)		Not used
RAISE6SECCAPACITY	NUMBER(9,6)		Not used
RAISE6SECMAX	NUMBER(9,6)		Limit Equation Raise 6 Second Maximum MW
PRICE6SECRAISEMANDATORY	NUMBER(16,6)		Not used
QUANT6SECRAISEMANDATORY	NUMBER(9,6)		Not used
PRICE6SECRAISECONTRACT	NUMBER(16,6)		Contract Price for 6 Second Raise
QUANT6SECRAISECONTRACT	NUMBER(9,6)		Contract Quantity for 6 Second Raise
PRICE60SECRAISEMANDATORY	NUMBER(16,6)		Not used
QUANT60SECRAISEMANDATORY	NUMBER(9,6)		Not used
PRICE60SECRAISECONTRACT	NUMBER(16,6)		Not used
QUANT60SECRAISECONTRACT	NUMBER(9,6)		Not used

PRICE6SECLOWERMANDATORY	NUMBER(16,6)		Not used
QUANT6SECLOWERMANDATORY	NUMBER(9,6)		Not used
PRICE6SECLOWERCONTRACT	NUMBER(16,6)		Not used
QUANT6SECLOWERCONTRACT	NUMBER(9,6)		Not used
PRICE60SECLOWERMANDATORY	NUMBER(16,6)		Not used
QUANT60SECLOWERMANDATORY	NUMBER(9,6)		Not used
PRICE60SECLOWERCONTRACT	NUMBER(16,6)		Not used
QUANT60SECLOWERCONTRACT	NUMBER(9,6)		Not used
AUTHORISED_BY	VARCHAR2(15)		User Name
AUTHORISED_DATE	DATE		Date Contract was Authorised
LASTCHANGED	DATE		Last date and time record changed
DEFAULT_TESTINGPAYMENT_AMOUNT	NUMBER(18,8)		The NMAS default payment amount
SERVICE_START_DATE	DATE		The NMAS Testing Service Start Date

5.5 Table: CONTRACTREACTIVEPOWER

5.5.1 CONTRACTREACTIVEPOWER

Name	CONTRACTREACTIVEPOWER
Comment	CONTRACTREACTIVEPOWER shows Reactive Power contract details used in the settlement and dispatch of this service.

5.5.2 Description

CONTRACTREACTIVEPOWER data is confidential to the relevant participant.

Source

CONTRACTREACTIVEPOWER updates only where there is a contract variation.

5.5.3 Notes

Name	Comment	Value
Visibility	Data in this table is:	Private

5.5.4 Primary Key Columns

- Name
- CONTRACTID
- VERSIONNO

5.5.5 Index Columns

- Name
- PARTICIPANTID

5.5.6 Index Columns

Name

LASTCHANGED

5.5.7 Content

Name	Data Type	Mandatory	Comment
CONTRACTID	VARCHAR2(10)	X	Contract Identifier
VERSIONNO	NUMBER(3,0)	X	Contract Version No.
STARTDATE	DATE		Starting Date of Contract
ENDDATE	DATE		Termination Date of Contract
PARTICIPANTID	VARCHAR2(10)		Unique participant identifier
DUID	VARCHAR2(10)		Dispatchable Unit ID
SYNCCOMPENSATION	VARCHAR2(1)		Sync Compensation Flag - Y for SYNCCOMP
MVARAPRICE	NUMBER(10,2)		Availability price per MVAR of RP absorption capability
MVAREPRICE	NUMBER(10,2)		Enabling price
MVARGPRICE	NUMBER(10,2)		Availability price per MVAR of RP generation capability
CCPRICE	NUMBER(10,2)		Compensation Cap
MTA	NUMBER(10,2)		Reactive Power Absorption Capability (MVAR)

MTG	NUMBER(10,2)		Reactive Power Generation Capability (MVAR)
MMCA	NUMBER(10,2)		Minimum Capability for MVAR Absorption required by Code
MMCG	NUMBER(10,2)		Minimum Capability for MVAR Generation required by Code
EU	NUMBER(10,2)		Estimated Power consumption of unit when operating on SYNCCOMP
PP	NUMBER(10,2)		Estimated Price for supply
BS	NUMBER(10,2)		Block Size of Unit
AUTHORISED_BY	VARCHAR2(15)		User Name
AUTHORISED_DATE	DATE		Date Contract was Authorised
LAST_CHANGED	DATE		Last date and time record changed
DEFAULT_TESTING_PAYMENT_AMOUNT	NUMBER(18,8)		The NMAS default payment amount
SERVICE_START_DATE	DATE		The NMAS Testing Service Start Date
AVAILABILITY_MWH_THRESHOLD	NUMBER(18,8)		The MWh the unit must produce in a trading interval to be eligible for an excess-to-gen availability payment
MVAR_THRESHOLD	NUMBER(18,8)		The threshold value for MegaVar (MVAR) to check whether the service is fully available.
REBATE_CAP	NUMBER(18,8)		The maximum capped amount for the rebate payment.

REBATE_AMOUNT_PER_MVAR	NUMBER(18,8)		The per MVAR rebate amount used to calculate the rebate payment.
ISREBATEAPPLICABLE	NUMBER(1,0)		Used to check whether the contract is eligible for rebate. For new NSCAS contracts to apply new payment methodology this flag is 1.

5.6 Table: CONTRACTRESTARTSERVICES

5.6.1 CONTRACTRESTARTSERVICES

Name	CONTRACTRESTARTSERVICES
Comment	CONTRACTRESTARTSERVICES shows Restart Services contract details used in the settlement and dispatch of this service.

5.6.2 Description

CONTRACTRESTARTSERVICES data is confidential to the participant holding the contract.

Source

CONTRACTRESTARTSERVICES updates only where there is a contract variation.

5.6.3 Notes

Name	Comment	Value
Visibility	Data in this table is:	Private

5.6.4 Primary Key Columns

- Name
- CONTRACTID
- VERSIONNO

5.6.5 Index Columns

- Name
- PARTICIPANTID

5.6.6 Index Columns

Name

LASTCHANGED

5.6.7 Content

Name	Data Type	Mandatory	Comment
CONTRACTID	VARCHAR2(10)	X	Contract Identifier
VERSIONNO	NUMBER(3,0)	X	Contract Version No.
STARTDATE	DATE		Starting Date of Contract
ENDDATE	DATE		Termination Date of Contract
PARTICIPANTID	VARCHAR2(10)		Unique participant identifier
RESTARTTYPE	NUMBER(1,0)		Restart Type - 0 = BlackStart, 1 = Combination, 2 = Trip To House
RCPRICE	NUMBER(6,2)		Availability Price
TRIPTOHOUSELEVEL	NUMBER(5,0)		Trip To House Level
AUTHORISED BY	VARCHAR2(15)		User Name
AUTHORISED DATE	DATE		Date Contract was Authorised
LASTCHANGED	DATE		Last date and time record changed
DEFAULT_TESTINGPAYMENT_AMOUNT	NUMBER(18,8)		The NMAS default payment amount
SERVICE_START_DATE	DATE		The NMAS Testing Service Start Date

5.7 Table: CONTRACTRESTARTUNITS

5.7.1 CONTRACTRESTARTUNITS

Name	CONTRACTRESTARTUNITS
Comment	CONTRACTRESTARTUNITS shows Restart units provided under a system restart contract. A service can have multiple units.

5.7.2 Description

CONTRACTRESTARTUNITS data is confidential to each participant with a restart contract.

Source

CONTRACTRESTARTUNITS updates only where there is a contract variation.

5.7.3 Notes

Name	Comment	Value
Visibility	Data in this table is:	Private

5.7.4 Primary Key Columns

- Name
- CONTRACTID
- DUID
- VERSIONNO

5.7.5 Index Columns

- Name
- LASTCHANGED

5.7.6 Index Columns

Name

CONTRACTID

5.7.7 Content

Name	Data Type	Mandatory	Comment
CONTRACTID	VARCHAR2(10)	X	Contract Identifier
VERSIONNO	NUMBER(3,0)	X	Version No of contract
DUID	VARCHAR2(10)	X	Dispatchable Unit identifier
LASTCHANGED	DATE		Last date and time record changed
AUTHORISED BY	VARCHAR2(15)		
AUTHORISED DATE	DATE		

6 Package: ASOFFER

Name ASOFFER
Comment Offer data for Ancillary Service Contracts

6.1 List of tables

Name	Comment
OFFERAGCDATA	OFFERAGCDATA shows availability reoffers of Automatic Generation Control.
OFFERASTRK	OFFERASTRK tracks successfully acknowledged ancillary service reoffers.
OFFERLSHEDDATA	OFFERLSHEDDATA shows reoffers of load shed including available load shed quantity.
OFFERRESTARTDATA	OFFERRESTARTDATA sets out reoffers of system restart availability.
OFFERRPOWERDATA	OFFERRPOWERDATA shows reoffers of reactive power capability and settlement measurements.

6.2 Diagram: Entities: Ancillary Service Contracts

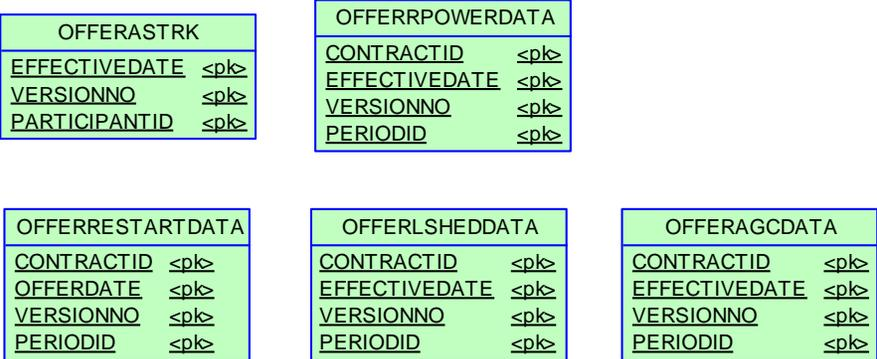

6.3 Table: OFFERAGCDATA

6.3.1 OFFERAGCDATA

Name	OFFERAGCDATA
Comment	OFFERAGCDATA shows availability reoffers of Automatic Generation Control.

6.3.2 Description

OFFERAGCDATA data is confidential to the relevant participant.

Source

OFFERAGCDATA updates as reoffers submitted.

6.3.3 Notes

Name	Comment	Value
Visibility	Data in this table is:	Private

6.3.4 Primary Key Columns

Name

CONTRACTID

EFFECTIVEDATE

PERIODID

VERSIONNO

6.3.5 Index Columns

Name

LASTCHANGED

6.3.6 Index Columns

Name

CONTRACTID

6.3.7 Content

Name	Data Type	Mandatory	Comment
CONTRACTID	VARCHAR2(10)	X	Contract Identifier
EFFECTIVEDATE	DATE	X	Market date of offer
VERSIONNO	NUMBER(3,0)	X	Version no of record
AVAILABILITY	NUMBER(4,0)		Availability flag (0 or 1)
UPPERLIMIT	NUMBER(4,0)		Upper control limit. This is used by SPD.
LOWERLIMIT	NUMBER(4,0)		Lower control limit MW. This is used by SPD.
AUTHORISEDDATE	DATE		Authorised date
AUTHORISEDBY	VARCHAR2(15)		Authorised by
FILENAME	VARCHAR2(40)		Name of reoffer file
LASTCHANGED	DATE		Last date and time record changed
PERIODID	NUMBER(3,0)	X	Market day trading interval number
AGCUP	NUMBER(3,0)		AGC Ramp Rate Up. This is used by SPD.

AGCDOWN	NUMBER(3,0)		AGC Ramp Rate Down. This is used by SPD.
---------	-------------	--	--

6.4 Table: OFFERASTRK

6.4.1 OFFERASTRK

Name	OFFERASTRK
Comment	OFFERASTRK tracks successfully acknowledged ancillary service reoffers.

6.4.2 Description

OFFERASTRK data is confidential to the relevant participant.

Source

OFFERASTRK is updated as offers are successfully acknowledged.

6.4.3 Notes

Name	Comment	Value
Visibility	Data in this table is:	Private

6.4.4 Primary Key Columns

Name
EFFECTIVEDATE
PARTICIPANTID
VERSIONNO

6.4.5 Index Columns

Name
LASTCHANGED

6.4.6 Content

Name	Data Type	Mandatory	Comment
EFFECTIVEDATE	DATE	X	Market day starting at 4:00 am
VERSIONNO	NUMBER(3,0)	X	Version of the offer for that date
PARTICIPANTID	VARCHAR2(10))	X	Participant ID
FILENAME	VARCHAR2(40))		Submitted file name.
LASTCHANGED	DATE		Last changed date and time.

6.5 Table: OFFERLSHEDDATA

6.5.1 OFFERLSHEDDATA

Name	OFFERLSHEDDATA
Comment	OFFERLSHEDDATA shows reoffers of load shed including available load shed quantity.

6.5.2 Description

OFFERLSHEDDATA data is confidential to the relevant participant.

Source

OFFERLSHEDDATA updates as reoffers process.

6.5.3 Notes

Name	Comment	Value
Visibility	Data in this table is:	Private

6.5.4 Primary Key Columns

- Name
- CONTRACTID
- EFFECTIVEDATE
- PERIODID
- VERSIONNO

6.5.5 Index Columns

- Name
- LASTCHANGED

6.5.6 Content

Name	Data Type	Mandatory	Comment
CONTRACTID	VARCHAR2(10)	X	Contract identifier
EFFECTIVEDATE	DATE	X	Market date of reoffer
VERSIONNO	NUMBER(3,0)	X	Version No of reoffer
AVAILABLELOAD	NUMBER(4,0)		Available load
AUTHORISEDDATE	DATE		Authorised date
AUTHORISEDBY	VARCHAR2(15)		Authorised by
FILENAME	VARCHAR2(40)		Name of reoffer file
LASTCHANGED	DATE		Last date and time record changed
PERIODID	NUMBER(3,0)	X	Market day trading interval number

6.6 Table: OFFERRESTARTDATA

6.6.1 OFFERRESTARTDATA

Name	OFFERRESTARTDATA
Comment	OFFERRESTARTDATA sets out reoffers of system restart availability.

6.6.2 Description

OFFERRESTARTDATA data is confidential to the relevant participant.

Source

OFFERRESTARTDATA updates as reoffers process.

6.6.3 Notes

Name	Comment	Value
Visibility	Data in this table is:	Private

6.6.4 Primary Key Columns

Name
 CONTRACTID
 OFFERDATE
 PERIODID
 VERSIONNO

6.6.5 Index Columns

Name
 LASTCHANGED

6.6.6 Content

Name	Data Type	Mandatory	Comment
CONTRACTID	VARCHAR2(10)	X	Contract identifier
OFFERDATE	DATE	X	Effective date of contract
VERSIONNO	NUMBER(3,0)	X	Version No of contract
AVAILABILITY	VARCHAR2(3)		Available load
AUTHORISEDDATE	DATE		Authorised date
AUTHORISEDBY	VARCHAR2(15)		Authorised by
FILENAME	VARCHAR2(40)		Name of reoffer file
LASTCHANGED	DATE		Last date and time record changed
PERIODID	NUMBER(3,0)	X	Market day trading interval number

6.7 Table: OFFERRPOWERDATA

6.7.1 OFFERRPOWERDATA

Name	OFFERRPOWERDATA
Comment	OFFERRPOWERDATA shows reoffers of reactive power capability and settlement measurements.

6.7.2 Description

OFFERRPOWERDATA data is confidential to the relevant participant.

Source

OFFERRPOWERDATA updates as reoffers process.

6.7.3 Notes

Name	Comment	Value
Visibility	Data in this table is:	Private

6.7.4 Primary Key Columns

Name

CONTRACTID

EFFECTIVEDATE

PERIODID

VERSIONNO

6.7.5 Index Columns

Name

LASTCHANGED

6.7.6 Index Columns

Name

CONTRACTID

6.7.7 Content

Name	Data Type	Mandatory	Comment
CONTRACTID	VARCHAR2(10)	X	Contract Version No.
EFFECTIVEDATE	DATE	X	Contract Version No.
VERSIONNO	NUMBER(3,0)	X	Version No. of Re-Offer
PERIODID	NUMBER(3,0)	X	Market trading interval
AVAILABILITY	NUMBER(3,0)		Availability of service
MTA	NUMBER(6,0)		Reactive Power Absorption Capability (MVar)
MTG	NUMBER(6,0)		Reactive Power Generation Capability (MVar)
AUTHORISEDDATE	DATE		Date Contract was Authorised
AUTHORISEDBY	VARCHAR2(15)		User Name
FILENAME	VARCHAR2(40)		File name of Re-Offer file
LASTCHANGED	DATE		Last date and time record changed

7 Package: BIDS

<i>Name</i>	BIDS
<i>Comment</i>	Energy and Market Based FCAS Offers

7.1 List of tables

Name	Comment
BIDDAYOFFER	BIDDAYOFFER shows the Energy and Ancillary Service bid data for each Market Day. BIDDAYOFFER is the parent table to BIDPEROFFER.
BIDDAYOFFER_D	BIDDAYOFFER_D shows the public summary of the energy and FCAS offers applicable in the Dispatch for the intervals identified. BIDDAYOFFER_D is the parent table to BIDPEROFFER_D.
BIDOFFERFILETRK	BIDOFFERFILETRK shows an audit trail of all files submitted containing an FCAS bid, including corrupt bids and rebids.
BIDPEROFFER	BIDPEROFFER shows period-based Energy and Ancillary Service bid data. BIDPEROFFER is a child table of BIDDAYOFFER.
BIDPEROFFER_D	BIDPEROFFER_D shows the public summary of the energy and FCAS offers applicable in the Dispatch for the intervals identified. BIDPEROFFER_D is the child to BIDDAYOFFER_D.
MNSP_DAYOFFER	MNSP_DAYOFFER shows price and other non-period data pertaining to a specific MNSP bid and Link ID to be effective from the given Settlement Date. MNSP_DAYOFFER is the parent table to

	MNSP_PEROFFER, and joins to MNSP_OFFERTRK.
MNSP_FILETRK	MNSP_FILETRK shows all MNSPOFFERS transmitted to the MMS system.
MNSP_OFFERTRK	MNSP_OFFERTRK records all valid MNSPOFFERS loaded into the MMS system. The authorised date reflects the date and time of the load. MNSP_OFFERTRK is key for tracking MNSP bid submission.
MNSP_PEROFFER	<p>MNSP_PEROFFER shows period by period availability and other period data pertaining to a specific bid and LinkID for the given Settlement Date.</p> <p>MNSP_PEROFFER is a child to MNSP_DAYOFFER and links to MNSP_OFFERTRK.</p>
MTPASA_OFFERDATA	Participant submitted Offers for MTPASA process
MTPASA_OFFERFILETRK	Participant submitted Offers for MTPASA process

7.2 Diagram: Entities: Bids

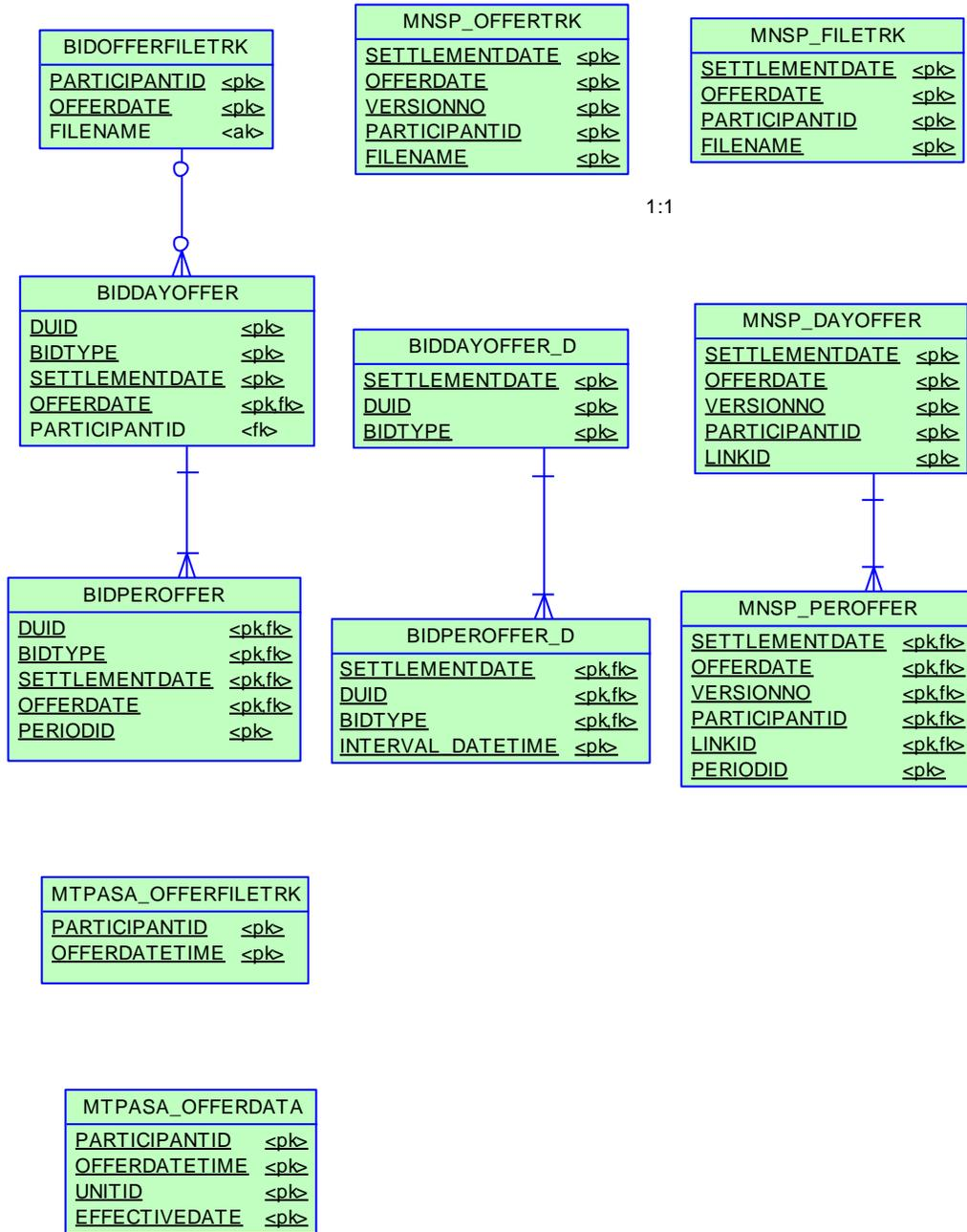

7.3 Table: BIDDAYOFFER

7.3.1 BIDDAYOFFER

Name	BIDDAYOFFER
Comment	BIDDAYOFFER shows the Energy and Ancillary Service bid data for each Market Day. BIDDAYOFFER is the parent table to BIDPEROFFER.

7.3.2 Description

The ancillary service arrangements require availability and prices for each Frequency Control Ancillary Service to be bid on a similar basis to energy. Three tables (BIDOFFERFILETRK, BIDDAYOFFER and BIDPEROFFER) facilitate ancillary service bidding and include energy bidding.

BIDDAYOFFER data is confidential to the submitting participant until made public after 4am the next day.

Source

BIDDAYOFFER updates as ancillary service bids are processed. BIDDAYOFFER includes all accepted energy and ancillary service bids.

Volume

Approximately 1,500,000 records per year

7.3.3 Notes

Name	Comment	Value
Visibility	Data in this table is:	Private; Public Next-Day

7.3.4 Primary Key Columns

- Name
- BIDTYPE
- DUID
- OFFERDATE
- SETTLEMENTDATE

7.3.5 Index Columns

Name

LASTCHANGED

7.3.6 Index Columns

Name

PARTICIPANTID

7.3.7 Content

Name	Data Type	Mandatory	Comment
DUID	VARCHAR2(10)	X	Dispatchable unit identifier
BIDTYPE	VARCHAR2(10)	X	Bid Type Identifier
SETTLEMENTDATE	DATE	X	Market date for applying the bid
OFFERDATE	DATE	X	Offer date of data
VERSIONNO	NUMBER(22,0)		Version No. for given offer date
PARTICIPANTID	VARCHAR2(10)		Unique participant identifier
DAILYENERGYCONSTRAINT	NUMBER(12,6)		Maximum energy available from Energy Constrained Plant. (Energy Bids Only)
REBIDEXPLANATION	VARCHAR2(500)		Explanation for all rebids and inflexibilities
PRICEBAND1	NUMBER(9,2)		Price for Availability Band 1

PRICEBAND2	NUMBER(9,2)		Price for Availability Band 2
PRICEBAND3	NUMBER(9,2)		Price for Availability Band 3
PRICEBAND4	NUMBER(9,2)		Price for Availability Band 4
PRICEBAND5	NUMBER(9,2)		Price for Availability Band 5
PRICEBAND6	NUMBER(9,2)		Price for Availability Band 6
PRICEBAND7	NUMBER(9,2)		Price for Availability Band 6
PRICEBAND8	NUMBER(9,2)		Price for Availability Band 8
PRICEBAND9	NUMBER(9,2)		Price for Availability Band 9
PRICEBAND10	NUMBER(9,2)		Price for Availability Band 10
MINIMUMLOAD	NUMBER(22,0)		Minimum MW load fast start plant
T1	NUMBER(22,0)		Time to synchronise in minutes (Energy Bids Only)
T2	NUMBER(22,0)		Time to minimum load in minutes (Energy Bids Only)
T3	NUMBER(22,0)		Time at minimum load in minutes (Energy Bids Only)
T4	NUMBER(22,0)		Time to shutdown in minutes (Energy Bids Only)
NORMALSTATUS	VARCHAR2(3)		not used; was ON/OFF for loads (Energy Bids Only)
LASTCHANGED	DATE		Last date and time record changed
MR_FACTOR	NUMBER(16,6)		Mandatory Restriction Offer Factor
ENTRYTYPE	VARCHAR2(20)		Daily if processed before BidCutOff of previous day, otherwise REBID

7.4 Table: BIDDAYOFFER_D

7.4.1 BIDDAYOFFER_D

Name	BIDDAYOFFER_D
Comment	BIDDAYOFFER_D shows the public summary of the energy and FCAS offers applicable in the Dispatch for the intervals identified. BIDDAYOFFER_D is the parent table to BIDPEROFFER_D.

7.4.2 Description

BIDDAYOFFER_D data is made public after 4am the next day.

Source

BIDDAYOFFER_D updates as ancillary service bids are processed. BIDDAYOFFER_D shows latest accepted energy and ancillary service bids.

Volume

Summary - approximately 1,000 rows per day

7.4.3 Notes

Name	Comment	Value
Visibility	Data in this table is:	Public

7.4.4 Primary Key Columns

- Name
- BIDTYPE
- DUID
- SETTLEMENTDATE

7.4.5 Index Columns

- Name

LASTCHANGED

7.4.6 Index Columns

Name

PARTICIPANTID

7.4.7 Content

Name	Data Type	Mandatory	Comment
SETTLEMENTDATE	DATE	X	Market date for which the bid applied
DUID	VARCHAR2(10)	X	Dispatchable unit identifier
BIDTYPE	VARCHAR2(10)	X	Bid Type Identifier
BIDSETTLEMENTDATE	DATE		Market date for which the bid was submitted.
OFFERDATE	DATE		Offer date and time
VERSIONNO	NUMBER(22,0)		Version No. for given offer date
PARTICIPANTID	VARCHAR2(10)		Unique participant identifier
DAILYENERGYCONSTRAINT	NUMBER(12,6)		Maximum energy available from Energy Constrained Plant. (Energy Bids Only)
REBIDEXPLANATION	VARCHAR2(500)		Explanation for all rebids and inflexibilities
PRICEBAND1	NUMBER(9,2)		Price for Availability Band 1

PRICEBAND2	NUMBER(9,2)		Price for Availability Band 2
PRICEBAND3	NUMBER(9,2)		Price for Availability Band 3
PRICEBAND4	NUMBER(9,2)		Price for Availability Band 4
PRICEBAND5	NUMBER(9,2)		Price for Availability Band 5
PRICEBAND6	NUMBER(9,2)		Price for Availability Band 6
PRICEBAND7	NUMBER(9,2)		Price for Availability Band 7
PRICEBAND8	NUMBER(9,2)		Price for Availability Band 8
PRICEBAND9	NUMBER(9,2)		Price for Availability Band 9
PRICEBAND10	NUMBER(9,2)		Price for Availability Band 10
MINIMUMLOAD	NUMBER(22,0)		Minimum MW load fast start plant
T1	NUMBER(22,0)		Time to synchronise in minutes (Energy Bids Only)
T2	NUMBER(22,0)		Time to minimum load in minutes (Energy Bids Only)
T3	NUMBER(22,0)		Time at minimum load in minutes (Energy Bids Only)
T4	NUMBER(22,0)		Time to shutdown in minutes (Energy Bids Only)
NORMALSTATUS	VARCHAR2(3)		ON/OFF for loads (Energy Bids Only)
LASTCHANGED	DATE		Last date and time record changed
MR_FACTOR	NUMBER(16,6)		Mandatory Restriction Scaling Factor
ENTRYTYPE	VARCHAR2(20)		Daily if processed before BidCutOff of previous day, otherwise REBID

7.5 Table: BIDOFFERFILETRK

7.5.1 BIDOFFERFILETRK

Name	BIDOFFERFILETRK
Comment	BIDOFFERFILETRK shows an audit trail of all files submitted containing an FCAS bid, including corrupt bids and rebids.

7.5.2 Description

BIDOFFERFILETRK data is confidential to the submitting participant.

The new ancillary service arrangements require availability and prices for each Frequency Control Ancillary Service to be bid on a similar basis to energy. Three new tables facilitate ancillary service bidding. The new tables (BIDOFFERFILETRK, BIDDAYOFFER and BIDPEROFFER) are similar in structure to energy bidding tables (OFFERFILETRK, DAYOFFER and PEROFFER). The significant differences with the new tables are.

- The OFFERDATE field reflects the time the bid was loaded and this field alone provides the key for versioning of bids. The VERSIONNO field is retained for participant use as information only.
- The new tables support bids for multiple services. The BIDTYPE field defines the service to which the bid applies.
- There are no default bids. In the absence of a bid for a specific settlement date, the latest bid submitted for a previous settlement date applies.

Source

This data is updated as bids are processed. It includes all bids submitted including corrupt bids.

Volume

Approximately 100,000 records per year

Note

Confirmation is via CSV bid acknowledgement file

7.5.3 Notes

Name	Comment	Value
Visibility	Data in this table is:	Private

7.5.4 Primary Key Columns

Name

FILENAME

7.5.5 Primary Key Columns

Name

OFFERDATE

PARTICIPANTID

7.5.6 Index Columns

Name

LASTCHANGED

7.5.7 Content

Name	Data Type	Mandatory	Comment
PARTICIPANTID	VARCHAR2(10)	X	Unique participant identifier
OFFERDATE	DATE	X	Date file offered
FILENAME	VARCHAR2(80)	X	Submitted file name
STATUS	VARCHAR2(10)		Load status [SUCCESSFUL/CORRUPT]
LASTCHANGED	DATE		Last date and time record changed
AUTHORISED BY	VARCHAR2(20)		Participant agent who created the Offer
AUTHORISED DATE	DATE		When the Offer was processed - synonymous with LastChanged

7.6 Table: BIDPEROFFER

7.6.1 BIDPEROFFER

Name	BIDPEROFFER
Comment	BIDPEROFFER shows period-based Energy and Ancillary Service bid data. BIDPEROFFER is a child table of BIDDAYOFFER.

7.6.2 Description

The new ancillary service arrangements require availability and prices for each Frequency Control Ancillary Service to be bid on a similar basis to energy. Three new tables facilitate ancillary service bidding. The new tables (BIDOFFERFILETRK, BIDDAYOFFER and BIDPEROFFER) are similar in structure to energy bidding tables (OFFERFILETRK, DAYOFFER and PEROFFER). The significant differences with the new tables are:

- The OFFERDATE field reflects the time the bid was loaded and this field alone provides the key for versioning of bids. The VERSIONNO field is retained for participant use as information only.
- The new tables support bids for multiple services. The BIDTYPE field defines the service to which the bid applies.
- There are no default bids. In the absence of a bid for a specific settlement date, the latest bid submitted for a previous settlement date applies.

BIDPEROFFER data is confidential to the submitting participant until made public after 4am the next day.

Source

BIDPEROFFER updates as energy and ancillary service bids are processed. BIDPEROFFER includes all accepted energy and ancillary service bids.

Volume

Approximately 72,000,000 records per year

7.6.3 Notes

Name	Comment	Value
Visibility	Data in this table is:	Private; Public Next-Day

7.6.4 Primary Key Columns

- Name
- BIDTYPE

DUID

OFFERDATE

PERIODID

SETTLEMENTDATE

7.6.5 Index Columns

Name

LASTCHANGED

7.6.6 Content

Name	Data Type	Mandatory	Comment
DUID	VARCHAR2(10)	X	Dispatchable Unit identifier
BIDTYPE	VARCHAR2(10)	X	Bid Type Identifier
SETTLEMENTDATE	DATE	X	Market date starting at 04:05
OFFERDATE	DATE	X	Offer date
PERIODID	NUMBER(22,0)	X	Period ID
VERSIONNO	NUMBER(22,0)		Version number of offer
MAXAVAIL	NUMBER(12,6)		Maximum availability for this BidType in this period
FIXEDLOAD	NUMBER(12,6)		Fixed unit output MW (Energy Bids Only) A value of zero means no fixed load so the unit is dispatched according to bid and market

			(rather than zero fixed load)
ROCUP	NUMBER(6,0)		MW/min for raise (Energy Bids Only)
ROCDOWN	NUMBER(6,0)		MW/Min for lower (Energy Bids Only)
ENABLEMENTMIN	NUMBER(6,0)		Minimum Energy Output (MW) at which this ancillary service becomes available (AS Only)
ENABLEMENTMAX	NUMBER(6,0)		Maximum Energy Output (MW) at which this ancillary service can be supplied (AS Only)
LOWBREAKPOINT	NUMBER(6,0)		Minimum Energy Output (MW) at which the unit can provide the full availability (MAXAVAIL) for this ancillary service (AS Only)
HIGHBREAKPOINT	NUMBER(6,0)		Maximum Energy Output (MW) at which the unit can provide the full availability (MAXAVAIL) for this ancillary service (AS Only)
BANDAVAIL1	NUMBER(22,0)		Availability at price band 1
BANDAVAIL2	NUMBER(22,0)		Availability at price band 2
BANDAVAIL3	NUMBER(22,0)		Availability at price band 3
BANDAVAIL4	NUMBER(22,0)		Availability at price band 4
BANDAVAIL5	NUMBER(22,0)		Availability at price band 5
BANDAVAIL6	NUMBER(22,0)		Availability at price band 6
BANDAVAIL7	NUMBER(22,0)		Availability at price band 7
BANDAVAIL8	NUMBER(22,0)		Availability at price band 8
BANDAVAIL9	NUMBER(22,0)		Availability at price band 9

BANDAVAIL10	NUMBER(22,0)		Availability at price band 10
LASTCHANGED	DATE		Last date and time record changed
PASAAVAILABILITY	NUMBER(12,0)		Allows for future use for energy bids, being the physical plant capability including any capability potentially available within 24 hours
MR_CAPACITY	NUMBER(6,0)		Mandatory Restriction Offer amount

7.7 Table: BIDPEROFFER_D

7.7.1 BIDPEROFFER_D

Name	BIDPEROFFER_D
Comment	BIDPEROFFER_D shows the public summary of the energy and FCAS offers applicable in the Dispatch for the intervals identified. BIDPEROFFER_D is the child to BIDDAYOFFER_D.

7.7.2 Description

BIDPEROFFER_D is public data, so is available to all participants.

Source

BIDPEROFFER_D updates daily shortly after 4am.

See also BIDPEROFFER.

7.7.3 Notes

Name	Comment	Value
Visibility	Data in this table is:	Public

7.7.4 Primary Key Columns

Name
 BIDTYPE
 DUID
 INTERVAL_DATETIME
 SETTLEMENTDATE

7.7.5 Index Columns

Name
 LASTCHANGED

7.7.6 Content

Name	Data Type	Mandatory	Comment
SETTLEMENTDATE	DATE	X	Market date for which the bid applied
DUID	VARCHAR2(10)	X	Dispatchable Unit identifier
BIDTYPE	VARCHAR2(10)	X	Bid Type Identifier
BIDSETTLEMENTDATE	DATE		Market date for which the bid was submitted
OFFERDATE	DATE		Offer date and time
PERIODID	NUMBER(22,0)		The trading interval period identifier (1-48)
VERSIONNO	NUMBER(22,0)		Version number of offer
MAXAVAIL	NUMBER(12,6)		Maximum availability for this BidType in this period
FIXEDLOAD	NUMBER(12,6)		Fixed unit output MW (Energy Bids Only). A value of zero means no fixed load so the unit is dispatched according to bid and market (rather than zero fixed load)
ROCUP	NUMBER(6,0)		MW/min for raise (Energy Bids Only)
ROCDOWN	NUMBER(6,0)		MW/Min for lower (Energy Bids Only)
ENABLEMENTMIN	NUMBER(6,0)		Minimum Energy Output (MW) at which this ancillary service

			becomes available (AS Only)
ENABLEMENTMAX	NUMBER(6,0)		Maximum Energy Output (MW) at which this ancillary service can be supplied (AS Only)
LOWBREAKPOINT	NUMBER(6,0)		Minimum Energy Output (MW) at which the unit can provide the full availability (MAXAVAIL) for this ancillary service (AS Only)
HIGHBREAKPOINT	NUMBER(6,0)		Maximum Energy Output (MW) at which the unit can provide the full availability (MAXAVAIL) for this ancillary service (AS Only)
BANDAVAIL1	NUMBER(22,0)		Availability at price band 1
BANDAVAIL2	NUMBER(22,0)		Availability at price band 2
BANDAVAIL3	NUMBER(22,0)		Availability at price band 3
BANDAVAIL4	NUMBER(22,0)		Availability at price band 4
BANDAVAIL5	NUMBER(22,0)		Availability at price band 5
BANDAVAIL6	NUMBER(22,0)		Availability at price band 6
BANDAVAIL7	NUMBER(22,0)		Availability at price band 7
BANDAVAIL8	NUMBER(22,0)		Availability at price band 8
BANDAVAIL9	NUMBER(22,0)		Availability at price band 9
BANDAVAIL10	NUMBER(22,0)		Availability at price band 10
LASTCHANGED	DATE		Last date and time record changed
PASAAVAILABILITY	NUMBER(12,0)		Allows for future use for energy bids, being the physical plant capability including any capability potentially available within 24 hours

INTERVAL_DATETIME	DATE	X	Date and Time of the dispatch interval to which the offer applied
MR_CAPACITY	NUMBER(6,0)		Mandatory Restriction Offer amount

7.8 Table: MNSP_DAYOFFER

7.8.1 MNSP_DAYOFFER

Name	MNSP_DAYOFFER
Comment	MNSP_DAYOFFER shows price and other non-period data pertaining to a specific MNSP bid and Link ID to be effective from the given Settlement Date. MNSP_DAYOFFER is the parent table to MNSP_PEROFFER, and joins to MNSP_OFFERTRK.

7.8.2 Description

MNSP_DAYOFFER shows own (confidential) data updates as bids are processed. All bids are available as part of next day market data.

Volume

4, 000 per year

7.8.3 Notes

Name	Comment	Value
Visibility	Data in this table is:	Private; Public Next-Day

7.8.4 Primary Key Columns

- Name
- LINKID
- OFFERDATE
- PARTICIPANTID
- SETTLEMENTDATE
- VERSIONNO

7.8.5 Index Columns

Name

LASTCHANGED

7.8.6 Content

Name	Data Type	Mandatory	Comment
SETTLEMENTDATE	DATE	X	Market Date from which bid is active
OFFERDATE	DATE	X	Offer date for bid
VERSIONNO	NUMBER(3,0)	X	Version of data for other key data - a higher version for same key data will take precedence
PARTICIPANTID	VARCHAR2(10)	X	Participant Identifier
LINKID	VARCHAR2(10)	X	Identifier for each of the two MNSP Interconnector Links. Each link pertains to the direction from and to.
ENTRYTYPE	VARCHAR2(20)		Bid type. Either Rebid or Daily
REBIDEXPLANATION	VARCHAR2(500)		Explanation for all rebids and inflexibilities
PRICEBAND1	NUMBER(9,2)		Price for Availability Band 1
PRICEBAND2	NUMBER(9,2)		Price for Availability Band 2
PRICEBAND3	NUMBER(9,2)		Price for Availability Band 3

PRICEBAND4	NUMBER(9,2)		Price for Availability Band 4
PRICEBAND5	NUMBER(9,2)		Price for Availability Band 5
PRICEBAND6	NUMBER(9,2)		Price for Availability Band 6
PRICEBAND7	NUMBER(9,2)		Price for Availability Band 7
PRICEBAND8	NUMBER(9,2)		Price for Availability Band 8
PRICEBAND9	NUMBER(9,2)		Price for Availability Band 9
PRICEBAND10	NUMBER(9,2)		Price for Availability Band 10
LASTCHANGED	DATE		Last date and time record changed
MR_FACTOR	NUMBER(16,6)		Mandatory Restriction Offer Factor

7.9 Table: MNSP_FILETRK

7.9.1 MNSP_FILETRK

Name	MNSP_FILETRK
Comment	MNSP_FILETRK shows all MNSPOFFERS transmitted to the MMS system.

7.9.2 Description

MNSP_FILETRK is confidential to the relevant participant.

Source

MNSP_FILETRK updates for every submitted MNSP bid.

Volume

4000 per year, being one per bid containing an MNSP bid

7.9.3 Notes

Name	Comment	Value
Visibility	Data in this table is:	Private

7.9.4 Primary Key Columns

Name
 FILENAME
 OFFERDATE
 PARTICIPANTID
 SETTLEMENTDATE

7.9.5 Index Columns

Name

LASTCHANGED

7.9.6 Content

Name	Data Type	Mandatory	Comment
SETTLEMENTDATE	DATE	X	Market Date from which bid is active
OFFERDATE	DATE	X	The actual date and time the bid file was submitted by the participant
PARTICIPANTID	VARCHAR2(10)	X	Participant Identifier
FILENAME	VARCHAR2(40)	X	File name for default bids, bids, rebids, re-offers or meter files, as appropriate to table
STATUS	VARCHAR2(10)		Load status [SUCCESSFUL/CORRUPT]
ACKFILENAME	VARCHAR2(40)		Acknowledge file name for bids, rebids
LASTCHANGED	DATE		Last date and time record changed

7.10 Table: MNSP_OFFERTRK

7.10.1 MNSP_OFFERTRK

Name	MNSP_OFFERTRK
Comment	MNSP_OFFERTRK records all valid MNSPOFFERS loaded into the MMS system. The authorised date reflects the date and time of the load. MNSP_OFFERTRK is key for tracking MNSP bid submission.

7.10.2 Description

MNSP_OFFERTRK shows own (confidential) data updates as bids are processed. All bids are available as part of next day market data.

Volume

4000 per year

7.10.3 Notes

Name	Comment	Value
Visibility	Data in this table is:	Private; Public Next-Day

7.10.4 Primary Key Columns

Name

FILENAME

OFFERDATE

PARTICIPANTID

SETTLEMENTDATE

VERSIONNO

7.10.5 Index Columns

Name

LASTCHANGED

7.10.6 Content

Name	Data Type	Mandatory	Comment
SETTLEMENTDATE	DATE	X	
OFFERDATE	DATE	X	
VERSIONNO	NUMBER(3,0)	X	
PARTICIPANTID	VARCHAR2(10)	X	
FILENAME	VARCHAR2(40)	X	
AUTHORISEDDATE	DATE		
AUTHORISEDBY	VARCHAR2(15)		
LASTCHANGED	DATE		

7.11 Table: MNSP_PEROFFER

7.11.1 MNSP_PEROFFER

Name	MNSP_PEROFFER
Comment	<p>MNSP_PEROFFER shows period by period availability and other period data pertaining to a specific bid and LinkID for the given Settlement Date.</p> <p>MNSP_PEROFFER is a child to MNSP_DAYOFFER and links to MNSP_OFFERTRK.</p>

7.11.2 Description

MNSP_PEROFFER shows own (confidential) data updates as bids are processed. All bids are available as part of next day market data.

Volume

192, 000 per year

7.11.3 Notes

Name	Comment	Value
Visibility	Data in this table is:	Private; Public Next-Day

7.11.4 Primary Key Columns

- Name
- LINKID
- OFFERDATE
- PARTICIPANTID
- PERIODID
- SETTLEMENTDATE

VERSIONNO

7.11.5 Index Columns

Name

LASTCHANGED

7.11.6 Content

Name	Data Type	Mandatory	Comment
SETTLEMENTDATE	DATE	X	Market Date from which bid is active
OFFERDATE	DATE	X	Offer date for bid
VERSIONNO	NUMBER(3,0)	X	Version of data for other key data - a higher version for same key data will take precedence
PARTICIPANTID	VARCHAR2(10)	X	Participant Identifier
LINKID	VARCHAR2(10)	X	Identifier for each of the two MNSP Interconnector Links. Each link pertains to the direction from and to.
PERIODID	NUMBER(22,0)	X	Trading Interval number
MAXAVAIL	NUMBER(6,0)		Maximum planned availability MW
BANDAVAIL1	NUMBER(6,0)		Band Availability for current Period
BANDAVAIL2	NUMBER(6,0)		Band Availability for current Period
BANDAVAIL3	NUMBER(6,0)		Band Availability for current Period

BANDAVAIL4	NUMBER(6,0)		Band Availability for current Period
BANDAVAIL5	NUMBER(6,0)		Band Availability for current Period
BANDAVAIL6	NUMBER(6,0)		Band Availability for current Period
BANDAVAIL7	NUMBER(6,0)		Band Availability for current Period
BANDAVAIL8	NUMBER(6,0)		Band Availability for current Period
BANDAVAIL9	NUMBER(6,0)		Band Availability for current Period
BANDAVAIL10	NUMBER(6,0)		Band Availability for current Period
LASTCHANGED	DATE		Last date and time record changed
FIXEDLOAD	NUMBER(12,6)		Inflexibility flag and availability. Fixed unit output MW. A value of zero means no fixed load so the unit is dispatched according to bid and market (rather than zero fixed load)
RAMPUPRATE	NUMBER(6,0)		Ramp rate (MW / min) in the positive direction of flow for this MNSP link for this half-hour period
PASAAVAILABILITY	NUMBER(12,0)		Allows for future use for energy bids, being the physical plant capability including any capability potentially available within 24 hours
MR_CAPACITY	NUMBER(6,0)		Mandatory Restriction Offer amount

7.12 Table: MTPASA_OFFERDATA

7.12.1 MTPASA_OFFERDATA

Name	MTPASA_OFFERDATA
Comment	Participant submitted Offers for MTPASA process

7.12.2 Notes

Name	Comment	Value
Visibility	Data in this table is:	Private;

7.12.3 Primary Key Columns

Name

EFFECTIVEDATE

OFFERDATETIME

PARTICIPANTID

UNITID

7.12.4 Index Columns

Name

LASTCHANGED

7.12.5 Content

Name	Data Type	Mandatory	Comment
PARTICIPANTID	VARCHAR2(20)	X	Unique participant identifier

)		
OFFERDATETIME	DATE	X	Date time file processed
UNITID	VARCHAR2(20)	X	either duid or mnsplinkid
EFFECTIVEDATE	DATE	X	trade date when the offer becomes effective
ENERGY	NUMBER(9)		weekly energy constraint value
CAPACITY1	NUMBER(9)		capacity value day 1 (sunday)
CAPACITY2	NUMBER(9)		capacity value day 2 (monday)
CAPACITY3	NUMBER(9)		capacity value day 3 (tuesday)
CAPACITY4	NUMBER(9)		capacity value day 4 (wednesday)
CAPACITY5	NUMBER(9)		capacity value day 5 (thursday)
CAPACITY6	NUMBER(9)		capacity value day 6 (friday)
CAPACITY7	NUMBER(9)		capacity value day 7 (saturday)
LASTCHANGED	DATE		timestamp when record last changed

7.13 Table: MTPASA_OFFERFILETRK

7.13.1 MTPASA_OFFERFILETRK

Name	MTPASA_OFFERFILETRK
Comment	Participant submitted Offers for MTPASA process

7.13.2 Description

MTPASA_OFFERFILETRK is confidential to the relevant participant.

Source

MTPASA_OFFERFILETRK updates for every submitted MTPASA bid.

Volume

4000 per year, being one per bid containing an MTPASA bid

7.13.3 Notes

Name	Comment	Value
Visibility	Data in this table is:	Private

7.13.4 Primary Key Columns

Name
OFFERDATETIME
PARTICIPANTID

7.13.5 Content

Name	Data Type	Mandatory	Comment
PARTICIPANTID	VARCHAR2(20)	X	Unique participant identifier

OFFERDATETIME	DATE	X	Date time file processed
FILENAME	VARCHAR2(200)		Submitted file name

8 Package: BILLING_CONFIG

<i>Name</i>	BILLING_CONFIG
<i>Comment</i>	Configuration data for the Billing Process

8.1 List of tables

Name	Comment
BILLINGCALENDAR	BILLINGCALENDAR sets out the billing calendar for the year, with week number 1 starting on 1 January. BILLINGCALENDAR advises preliminary and final statement posting date and corresponding settlement for each billing week.
GST_BAS_CLASS	GST_BAS_CLASS contains a static list of BAS (Business Activity Statement) classifications supported by the MMS.
GST_RATE	GST_RATE maintains the GST rates on a BAS (Business Activity Statement) class basis.
GST_TRANSACTION_CLASS	GST_TRANSACTION_CLASS maps NEM settlement transaction types with BAS (Business Activity Statement) classifications.
GST_TRANSACTION_TYPE	GST_TRANSACTION_TYPE shows a static list of transaction types supported by the MMS.
SECDEPOSIT_INTEREST_RATE	The security deposit interest rate on a daily basis. This is the public table published when the business enter and authorise a new daily interest rate
SECDEPOSIT_PROVISION	The security deposit provision entry details

8.2 Diagram: Entities: Billing Config

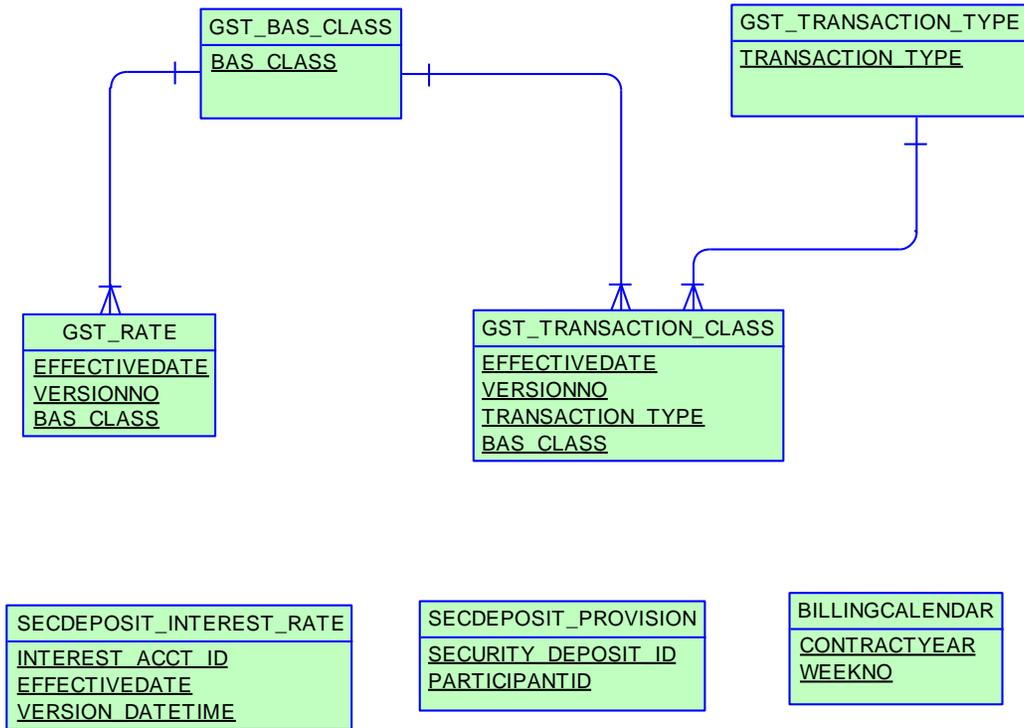

8.3 Table: BILLINGCALENDAR

8.3.1 BILLINGCALENDAR

Name	BILLINGCALENDAR
Comment	BILLINGCALENDAR sets out the billing calendar for the year, with week number 1 starting on 1 January. BILLINGCALENDAR advises preliminary and final statement posting date and corresponding settlement for each billing week.

8.3.2 Description

BILLINGCALENDAR is public data, and is available to all participants.

Source

Infrequently, only when inserting billing weeks for a future contractyear.

Volume

52-53 records inserted per contractyear

8.3.3 Notes

Name	Comment	Value
Visibility	Data in this table is:	Public

8.3.4 Primary Key Columns

Name
 CONTRACTYEAR
 WEEKNO

8.3.5 Index Columns

Name

LASTCHANGED

8.3.6 Content

Name	Data Type	Mandatory	Comment
CONTRACTYEAR	NUMBER(4,0)	X	AEMO Contract Year number starting in week containing 1st January
WEEKNO	NUMBER(3,0)	X	Week no within the contract year. Week no 1 is the week containing 1st January
STARTDATE	DATE		Start Date of week
ENDDATE	DATE		End Date of week
PRELIMINARYSTATEMENTDATE	DATE		Preliminary Statement Date
FINALSTATEMENTDATE	DATE		Final Statement Date
PAYMENTDATE	DATE		Payment Date
LASTCHANGED	DATE		Last date and time record changed
REVISION1_STATEMENTDATE	DATE		Revision 1 Statement Date for the billing week.
REVISION2_STATEMENTDATE	DATE		Revision 2 Statement Date for the billing week.

8.4 Table: GST_BAS_CLASS

8.4.1 GST_BAS_CLASS

Name	GST_BAS_CLASS
Comment	GST_BAS_CLASS contains a static list of BAS (Business Activity Statement) classifications supported by the MMS.

8.4.2 Description

GST_BAS_CLASS data is public to all participants.

8.4.3 Notes

Name	Comment	Value
Visibility	Data in this table is:	Public

8.4.4 Primary Key Columns

Name
BAS_CLASS

8.4.5 Index Columns

Name
LASTCHANGED

8.4.6 Content

Name	Data Type	Mandatory	Comment
BAS_CLASS	VARCHAR2(30))	X	The BAS classification

DESCRIPTION	VARCHAR2(100)		Description of the BAS classification
LASTCHANGED	DATE		Last date and time the record changed

8.5 Table: GST_RATE

8.5.1 GST_RATE

Name	GST_RATE
Comment	GST_RATE maintains the GST rates on a BAS (Business Activity Statement) class basis.

8.5.2 Description

GST_RATE data is public to all participants.

8.5.3 Notes

Name	Comment	Value
Visibility	Data in this table is:	Public

8.5.4 Primary Key Columns

Name
 BAS_CLASS
 EFFECTIVEDATE
 VERSIONNO

8.5.5 Index Columns

Name
 LASTCHANGED

8.5.6 Content

Name	Data Type	Mandatory	Comment
------	-----------	-----------	---------

EFFECTIVEDATE	DATE	X	The effective date of the data set
VERSIONNO	NUMBER(3,0)	X	The version number of the data set
BAS_CLASS	VARCHAR2(30)	X	The BAS classification
GST_RATE	NUMBER(8,5)		The GST rate that applies to this BAS classification
LASTCHANGED	DATE		Last date and time the record changed

8.6 Table: GST_TRANSACTION_CLASS

8.6.1 GST_TRANSACTION_CLASS

Name	GST_TRANSACTION_CLASS
Comment	GST_TRANSACTION_CLASS maps NEM settlement transaction types with BAS (Business Activity Statement) classifications.

8.6.2 Description

GST_TRANSACTION_CLASS data is public to all participants.

Source

GST_TRANSACTION_CLASS updates infrequently, when new transactions are introduced to the NEM.

Volume

Generally volume is fewer than one hundred records.

8.6.3 Notes

Name	Comment	Value
Visibility	Data in this table is:	Public

8.6.4 Primary Key Columns

- Name
- BAS_CLASS
- EFFECTIVEDATE
- TRANSACTION_TYPE
- VERSIONNO

8.6.5 Index Columns

- Name

LASTCHANGED

8.6.6 Content

Name	Data Type	Mandatory	Comment
EFFECTIVEDATE	DATE	X	The effective date of the data set
VERSIONNO	NUMBER(3,0)	X	The version number of the data set
TRANSACTION_TYPE	VARCHAR2(30)	X	NEM settlement transaction type
BAS_CLASS	VARCHAR2(30)	X	The BAS classification that the transaction type corresponds to
LASTCHANGED	DATE		Last date and time the record changed

8.7 Table: GST_TRANSACTION_TYPE

8.7.1 GST_TRANSACTION_TYPE

Name	GST_TRANSACTION_TYPE
Comment	GST_TRANSACTION_TYPE shows a static list of transaction types supported by the MMS.

8.7.2 Description

GST_TRANSACTION_TYPE data is public to all participants.

8.7.3 Notes

Name	Comment	Value
Visibility	Data in this table is:	Public

8.7.4 Primary Key Columns

Name
TRANSACTION_TYPE

8.7.5 Index Columns

Name
LASTCHANGED

8.7.6 Content

Name	Data Type	Mandatory	Comment
TRANSACTION_TYPE	VARCHAR2(30)	X	The transaction type

DESCRIPTION	VARCHAR2(100)		Description of the transaction type
GL_FINANCIALCODE	VARCHAR2(10)		
GL_TCODE	VARCHAR2(15)		
LASTCHANGED	DATE		Last date and time the record changed

8.8 Table: SECDEPOSIT_INTEREST_RATE

8.8.1 SECDEPOSIT_INTEREST_RATE

Name	SECDEPOSIT_INTEREST_RATE
Comment	The security deposit interest rate on a daily basis. This is the public table published when the business enter and authorise a new daily interest rate

8.8.2 Description

SECDEPOSIT_INTEREST_RATE data is public to all participants.

8.8.3 Notes

Name	Comment	Value
Visibility	Data in this table is:	Public

8.8.4 Primary Key Columns

Name

EFFECTIVEDATE

INTEREST_ACCT_ID

VERSION_DATETIME

8.8.5 Content

Name	Data Type	Mandatory	Comment
INTEREST_ACCT_ID	VARCHAR2(20)	X	The interest account ID for calculating the interest payment
EFFECTIVEDATE	DATE	X	The effective date of the interest rate change

VERSION_DATETIME	DATE	X	Date Time this record was added
INTEREST_RATE	NUMBER(18,8)		The interest rate for the interest account ID as on the effective date.

8.9 Table: SECDEPOSIT_PROVISION

8.9.1 SECDEPOSIT_PROVISION

Name	SECDEPOSIT_PROVISION
Comment	The security deposit provision entry details

8.9.2 Notes

Name	Comment	Value
Visibility	Data in this table is:	Private

8.9.3 Primary Key Columns

Name
PARTICIPANTID
SECURITY_DEPOSIT_ID

8.9.4 Content

Name	Data Type	Mandatory	Comment
SECURITY_DEPOSIT_ID	VARCHAR2(20)	X	The security deposit ID
PARTICIPANTID	VARCHAR2(20)	X	The Participant ID linked to the security deposit ID
TRANSACTION_DATE	DATE		The date the security deposit ID is entered and authorised by settlements
MATURITY_CONTRACTYEAR	NUMBER(4,0)		The contract year of the billing week when the security deposit is

			maturing
MATURITY_WEEKNO	NUMBER(3,0)		The week no of the billing week when the security deposit is maturing
AMOUNT	NUMBER(18,8)		The security deposit amount
INTEREST_RATE	NUMBER(18,8)		The interest rate assigned to the security deposit ID. Null if INTEREST_CALC_TYPE <> FIXED
INTEREST_CALC_TYPE	VARCHAR2(20))		FIXED OR DAILY
INTEREST_ACCT_ID	VARCHAR2(20))		The Interest Account ID for calculating the Interest Payment. This is NULL if the INTEREST_CALC_TYPE = FIXED

9 Package: BILLING_RUN

Name BILLING_RUN

Comment Results from a published Billing Run. The settlement data and billing run data are updated daily between 6am and 8am for AEMO's prudential processes. In a normal week, AEMO publishes one PRELIM, one FINAL and two REVISION runs in addition to the daily runs.

Each billing run is uniquely identified by contract year, week no and bill run no.

9.1 List of tables

Name	Comment
BILLING_APC_COMPENSATION	Billing result table for APC compensation payments.
BILLING_APC_RECOVERY	Billing result table for recovery of APC compensation payments
BILLING_CO2E_PUBLICATION	Carbon Dioxide Intensity Index publication table
BILLING_CO2E_PUBLICATION_TRACK	Carbon Dioxide Intensity Index publication tracking table
BILLING_DAILY_ENERGY_SUMMARY	Billing result table containing daily summary data for customer and generator energy amounts
BILLING_DIRECTION_RECON_OTHER	Billing reconciliation result table for both provisional and final directions
BILLING_DIRECTION_RECONCILIATION	Billing reconciliation result table for both provisional and final directions using the FPP methodology (prior to 1st July 2011)
BILLING_EFTSHORTFALL_AMOUNT	The billing shortfall run amounts
BILLING_EFTSHORTFALL_DETAIL	The Billing Shortfall Run Amount details

BILLING_GST_DETAIL	BILLING_GST_DETAIL shows the BAS class, GST_Exclusive and GST amount (if any) attributable to a participant for each transaction type.
BILLING_GST_SUMMARY	BILLING_GST_SUMMARY shows the GST_Exclusive and GST amount (if any) attributable to a participant for each BAS class.
BILLING_MR_PAYMENT	BILLING_MR_PAYMENT shows aggregate payments on a dispatchable unit/MR Event basis for accepted MR capacity
BILLING_MR_RECOVERY	BILLING_MR_RECOVERY shows aggregate recovery charges on a dispatchable unit / MR Event basis for spot market income from dispatch of MR capacity.
BILLING_MR_SHORTFALL	BILLING_MR_SHORTFALL shows aggregate MR shortfall payments (or recovery charges) to each participant in the region for the MR event.
BILLING_MR_SUMMARY	BILLING_MR_SUMMARY shows aggregate payment/recovery and shortfall figures for an MR Event.
BILLING_NMAS_TST_PAYMENTS	BILLING_NMAS_TEST_PAYMENTS publish the NSCAS/SRAS Testing Payments data for a posted billing week.
BILLING_NMAS_TST_RECOVERY	BILLING_NMAS_TEST_RECOVERY sets out the recovery of NMAS testing payments
BILLING_NMAS_TST_RECVRY_RBF	BILLING_NMAS_TEST_RECVRY_RBF sets out the NSCAS/SRAS Testing Payment recovery data for the posted billing week.
BILLING_NMAS_TST_RECVRY_TRK	BILLING_NMAS_TEST_RECVRY_TRK tracks the energy data used to allocate the test payment recovery over the recovery period.
BILLING_RES_TRADER_PAYMENTS	Billing result table for reserve trader contract payments

BILLING_RES_TRADER_RECOVERY	Billing result table for reserve trader contract recovery
BILLING_SECDEP_INTEREST_PAY	The interest amount for security deposit calculated by billing, based on whether it is a fixed/floating rate
BILLING_SECDEP_INTEREST_RATE	The DAILY interest rates used by billing when calculating the interest amount
BILLING_SECDEPOSIT_APPLICATION	The security deposit application details
BILLINGAPCCOMPENSATION	BILLINGAPCCOMPENSATION shows Administered Price Cap (APC) compensation amounts for the billing period. Data is for each participant by region.
BILLINGAPCRECOVERY	BILLINGAPCRECOVERY shows the Administered Price Cap (APC) Recovery for the billing period. Data is for each participant by region.
BILLINGASPAYMENTS	BILLINGASPAYMENTS shows Ancillary Service payments for each billing period by each of the Ancillary Service types for each participant's connection points.
BILLINGASRECOVERY	BILLINGASRECOVERY shows participant charges for Ancillary Services for the billing period. This view shows the billing amounts for Ancillary Service Recovery.
BILLINGCPDATA	BILLINGCPDATA shows energy quantity and \$ value purchased per participant connection point.
BILLINGDAYTRK	BILLINGDAYTRK is key for matching settlement versions with billing runs. BILLINGDAYTRK displays the billrunnos per billing week, and the settlement version numbers per settlement day comprising the billrunno.
BILLINGFEES	BILLINGFEES presents pool fees applied to the statement, per billing run.
BILLINGFINANCIALADJUSTMENTS	BILLINGFINANCIALADJUSTMENTS contains any manual adjustments included in the billing run.

BILLINGGENDATA	BILLINGGENDATA shows the total energy sold and purchased per participant transmission connection point for a billing period.
BILLINGINTERRESIDUES	BILLINGINTERRESIDUES shows interregion residues payable to NSP.
BILLINGINTRARESIDUES	BILLINGINTRARESIDUES shows intra-region settlement residue details for each Transmission Network Service Provider participant by region.
BILLINGIRAUCSURPLUS	BILLINGIRAUCSURPLUS supports the Settlements Residue Auction, by showing the weekly billing Interconnector Residue (IR) payments as calculated for each bill run for Network Service Providers (NSPs) from the amount not auctioned.
BILLINGIRAUCSURPLUSSUM	BILLINGIRAUCSURPLUSSUM contains Auction fees and Settlements Residue Auction distribution that may arise from unpurchased auction units that accrue to Transmission Network Service Providers.
BILLINGIRFM	BILLINGIRFM shows billing amounts associated with Industrial Relations Forced Majeure events for each participant.
BILLINGIRNSPSURPLUS	BILLINGIRNSPSURPLUS supports the Settlements Residue Auction (SRA), by showing the weekly billing Interconnector Residue (IR) payments as calculated for each bill run for Transmission Network Service Providers (TNSP) from the amount paid by participants (i.e. derogated amounts).
BILLINGIRNSPSURPLUSSUM	BILLINGIRNSPSURPLUSSUM contains derogated payments made to TNSPs arising from the Settlements Residue Auction process.
BILLINGIRPARTSURPLUS	BILLINGIRPARTSURPLUS supports the Settlements Residue Auction, by showing the weekly billing SRA distribution to Auction participants by Contract Identifier.

BILLINGIRPARTSURPLUSSUM	BILLINGIRPARTSURPLUSSUM supports the Settlements Residue Auction, by showing the weekly billing SRA distribution and associated fees to Auction participants.
BILLINGPRIORADJUSTMENTS	BILLINGPRIORADJUSTMENTS sets out prior period adjustments and associated interest inserted in subsequent Final Statements arising from Revision Statement postings.
BILLINGREALLOC	BILLINGREALLOC shows reallocation contract values in each billing run, where participants have used reallocations.
BILLINGREALLOC_DETAIL	Billing Reallocation Data aggregated by REALLOCATIONID for each billing run over the billing week.
BILLINGREGIONEXPORTS	BILLINGREGIONEXPORTS sets out the region summary table of overall energy exported to and from each region for each billing run.
BILLINGREGIONFIGURES	BILLINGREGIONFIGURES sets out additional summary region details including ancillary service amounts for each billing run.
BILLINGREGIONIMPORTS	BILLINGREGIONIMPORTS sets out the region summary table of overall energy imported to and from each region for each billing run.
BILLINGRUNTRK	BILLINGRUNTRK identifies the Statement type (i.e. Status of PRELIM, FINAL, REVISE) and date of the BillRunNo posted, per WeekNo. This provides a further extension of tracking data from the BILLINGDAYTRK table.
BILLINGSMELTERREDUCTION	BILLINGSMELTERREDUCTION shows the smelter reduction payment (only applies to participants with Victorian customer connection points).
BILLWHITEHOLE	BILLWHITEHOLE shows white hole payments based on participant vs region demand.

9.3 Table: BILLING_APC_COMPENSATION

9.3.1 BILLING_APC_COMPENSATION

Name BILLING_APC_COMPENSATION
 Comment Billing result table for APC compensation payments.

9.3.2 Description

Updated with each billing run

9.3.3 Notes

Name	Comment	Value
Visibility	Data in this table is:	Private

9.3.4 Primary Key Columns

Name
 APEVENTID
 BILLRUNNO
 CLAIMID
 CONTRACTYEAR
 WEEKNO

9.3.5 Content

Name	Data Type	Mandatory	Comment
CONTRACTYEAR	NUMBER(4)	X	Billing contract year
WEEKNO	NUMBER(3)	X	Billing week number

BILLRUNNO	NUMBER(3)	X	Billing run number
APEVENTID	NUMBER(6)	X	AP Event Id
CLAIMID	NUMBER(6)	X	AP Event Claim Id
PARTICIPANTID	VARCHAR2(20)		Participant identifier
COMPENSATION_AMOUNT	NUMBER(18,8)		Payment amount to the participant
EVENT_TYPE	VARCHAR2(20)		The Administered Price Event Type. Valid values: ENERGY, FCAS, BOTH
COMPENSATION_TYPE	VARCHAR2(20)		The Type of Administered Price Compensation Claim. Valid values: DIRECT_COST, OTHER_COST
LASTCHANGED	DATE		The date and time of last changed record

9.4 Table: BILLING_APC_RECOVERY

9.4.1 BILLING_APC_RECOVERY

Name	BILLING_APC_RECOVERY
Comment	Billing result table for recovery of APC compensation payments

9.4.2 Description

Updated with each billing run

9.4.3 Notes

Name	Comment	Value
Visibility	Data in this table is:	Private

9.4.4 Primary Key Columns

Name

APEVENTID

BILLRUNNO

CLAIMID

CONTRACTYEAR

PARTICIPANTID

REGIONID

WEEKNO

9.4.5 Content

Name	Data Type	Mandatory	Comment

CONTRACTYEAR	NUMBER(4)	X	Billing contract year
WEEKNO	NUMBER(3)	X	Billing week number
BILLRUNNO	NUMBER(3)	X	Billing run number
APEVENTID	NUMBER(6)	X	AP Event Id
CLAIMID	NUMBER(6)	X	AP Event Claim Id
PARTICIPANTID	VARCHAR2(20)	X	Participant identifier
REGIONID	VARCHAR2(20)	X	Region Identifier
RECOVERY_AMOUNT	NUMBER(18,8)		Recovery amount attributable to the participant in that region
ELIGIBILITY_START_INTERVAL	DATE		The starting half hourly interval for the eligibility period for recovery of APC Payment
ELIGIBILITY_END_INTERVAL	DATE		The ending half hourly interval for the eligibility period for recovery of APC Payment
PARTICIPANT_DEMAND	NUMBER(18,8)		The participant demand in the cost recovery region
REGION_DEMAND	NUMBER(18,8)		The sum of demand of all participants in the cost recovery region (Region Sum)
LASTCHANGED	DATE		The date and time of last changed record

9.5 Table: BILLING_CO2E_PUBLICATION

9.5.1 BILLING_CO2E_PUBLICATION

Name	BILLING_CO2E_PUBLICATION
Comment	Carbon Dioxide Intensity Index publication table

9.5.2 Notes

Name	Comment	Value
Visibility	Data in this table is:	Public

9.5.3 Primary Key Columns

- Name
- CONTRACTYEAR
- REGIONID
- SETTLEMENTDATE
- WEEKNO

9.5.4 Index Columns

- Name
- CONTRACTYEAR
- WEEKNO
- SETTLEMENTDATE
- REGIONID

9.5.5 Content

Name	Data Type	Mandatory	Comment
CONTRACTYEAR	NUMBER(4)	X	Billing contract year
WEEKNO	NUMBER(3)	X	Billing week no
BILLRUNNO	NUMBER(3)	X	Billing run no
SETTLEMENTDATE	DATE	X	Settlement Date (Calendar)
REGIONID	VARCHAR(20)	X	Region identifier
SENTOUTENERGY	NUMBER(18,8)		Total sent out energy for region (MWh)
GENERATOREMISSIONS	NUMBER(18,8)		Total generator emissions for region (Co2-e)
INTENSITYINDEX	NUMBER(18,8)		Carbon Dioxide Intensity index for region (CO2-e/MWh)

9.6 Table: BILLING_CO2E_PUBLICATION_TRK

9.6.1 BILLING_CO2E_PUBLICATION_TRK

Name	BILLING_CO2E_PUBLICATION_TRK
Comment	Carbon Dioxide Intensity Index publication tracking table

9.6.2 Notes

Name	Comment	Value
Visibility	Data in this table is:	Public

9.6.3 Primary Key Columns

Name
 CONTRACTYEAR
 WEEKNO

9.6.4 Index Columns

Name
 CONTRACTYEAR
 WEEKNO

9.6.5 Content

Name	Data Type	Mandatory	Comment
CONTRACTYEAR	NUMBER(4)	X	Billing contract year
WEEKNO	NUMBER(3)	X	Billing week no

BILLRUNNO	NUMBER(3)		Billing run no
LASTCHANGED	DATE		Last changed date time

9.7 Table: BILLING_DAILY_ENERGY_SUMMARY

9.7.1 BILLING_DAILY_ENERGY_SUMMARY

Name	BILLING_DAILY_ENERGY_SUMMARY
Comment	Billing result table containing daily summary data for customer and generator energy amounts

9.7.2 Description

BILLING_DAILY_ENERGY_SUMMARY data is confidential to the relevant participant.

Source

Populated by the posting of a billing run.

Volume

Approximately 20 records per billrunno.

9.7.3 Notes

Name	Comment	Value
Visibility	Data in this table is:	Private

9.7.4 Primary Key Columns

- Name
- BILLRUNNO
- CONTRACTYEAR
- PARTICIPANTID
- REGIONID
- SETTLEMENTDATE
- WEEKNO

9.7.5 Content

Name	Data Type	Mandatory	Comment
CONTRACTYEAR	NUMBER(4,0)	X	Billing Contract Year
WEEKNO	NUMBER(3,0)	X	Billing Week number
BILLRUNNO	NUMBER(3,0)	X	Billing Run number
SETTLEMENTDATE	DATE	X	settlement date
PARTICIPANTID	VARCHAR2(20)	X	participant identifier
REGIONID	VARCHAR2(20)	X	Unique Region Identifier
CUSTOMER_ENERGY_PURCHASED	NUMBER(18,8)		customer energy amount purchased on this settlement day by the participant in the region
GENERATOR_ENERGY_SOLD	NUMBER(18,8)		generator energy amount sold on this settlement day by the participant in the region
GENERATOR_ENERGY_PURCHASED	NUMBER(18,8)		generator energy amount purchased on this settlement day by the participant in the region

9.8 Table: BILLING_DIRECTION_RECON_OTHER

9.8.1 BILLING_DIRECTION_RECON_OTHER

Name	BILLING_DIRECTION_RECON_OTHER
Comment	Billing reconciliation result table for both provisional and final directions

9.8.2 Notes

Name	Comment	Value
Visibility	Data in this table is:	Public

9.8.3 Primary Key Columns

Name

BILLRUNNO

CONTRACTYEAR

DIRECTION_ID

REGIONID

WEEKNO

9.8.4 Index Columns

Name

CONTRACTYEAR

WEEKNO

BILLRUNNO

DIRECTION_ID

REGIONID

9.8.5 Content

Name	Data Type	Mandatory	Comment
CONTRACTYEAR	NUMBER(4)	X	Billing contract year
WEEKNO	NUMBER(3)	X	Billing week no
BILLRUNNO	NUMBER(3)	X	Billing run no
DIRECTION_ID	VARCHAR2(20)	X	Direction identifier
REGIONID	VARCHAR2(20)	X	Region Identifier
DIRECTION_DESC	VARCHAR2(200)		Direction description
DIRECTION_TYPE_ID	VARCHAR2(20)		The service for which the direction occurred (ENERGY, ANCILLARY, NON_ENERGY_NON_AS, etc)
DIRECTION_START_DATE	DATE		Settlement day on which the direction starts
DIRECTION_END_DATE	DATE		Settlement day on which the direction ends. The same value for all regions
DIRECTION_START_INTERVAL	DATE		Dispatch interval in which the direction starts. The same value for all regions
DIRECTION_END_INTERVAL	DATE		Dispatch interval in which the direction ends. The same value for all regions

COMPENSATION_AMOUNT	NUMBER(18,8)		The final compensation amount for the direction. The same value for all regions
INTEREST_AMOUNT	NUMBER(18,8)		The interest amount calculated on the final compensation amount for the direction. The same value for all regions
INDEPENDENT_EXPERT_FEE	NUMBER(18,8)		The independent expert fee amount for the direction. The same value for all regions
CRA	NUMBER(18,8)		The total recovery amount for the direction. The same value for all regions
REGIONAL_CUSTOMER_ENERGY	NUMBER(18,8)		The total customer energy for this region, over the duration of the direction
REGIONAL_GENERATOR_ENERGY	NUMBER(18,8)		The total generator energy for this region, over the duration of the direction
REGIONAL_BENEFIT_FACTOR	NUMBER(18,8)		The regional benefit factor allocated to this region for the direction

9.9 Table: BILLING_DIRECTION_RECONCILIATN

9.9.1 BILLING_DIRECTION_RECONCILIATN

Name	BILLING_DIRECTION_RECONCILIATN
Comment	Billing reconciliation result table for both provisional and final directions using the FPP methodology (prior to 1st July 2011)

9.9.2 Description

Source

BILLING_DIRECTION_RECONCILIATN is populated by the posting of a billing run.

Volume

One record inserted per direction per billing run, or 11 records inserted per week. Presently

9.9.3 Notes

Name	Comment	Value
Visibility	Data in this table is:	Public

9.9.4 Primary Key Columns

Name
 BILLRUNNO
 CONTRACTYEAR
 DIRECTION_ID
 WEEKNO

9.9.5 Index Columns

Name
 LASTCHANGED

9.9.6 Content

Name	Data Type	Mandatory	Comment
CONTRACTYEAR	NUMBER(4)	X	Billing contract year
WEEKNO	NUMBER(3)	X	Billing week no
BILLRUNNO	NUMBER(3)	X	Billing run no
DIRECTION_ID	VARCHAR2(20)	X	Direction identifier
DIRECTION_DESC	VARCHAR2(200)		Direction description
DIRECTION_START_DATE	DATE		Direction start date time
DIRECTION_END_DATE	DATE		Direction end date time
COMPENSATION_AMOUNT	NUMBER(16,6)		Direction compensation amount
INDEPENDENT_EXPERT_FEE	NUMBER(16,6)		Independent expert fee charged on calculating direction compensation amount
INTEREST_AMOUNT	NUMBER(16,6)		Interest occurred on direction compensation amount
CRA	NUMBER(16,6)		Direction compensation recovery amount
NEM_FEE_ID	VARCHAR2(20)		Fixed settlement fee identifier for direction purpose
NEM_FIXED_FEE_AMOUNT	NUMBER(16,6)		Fixed settlement fee for participants between direction start and end date
MKT_CUSTOMER_PERC	NUMBER(16,6)		Direction compensation recovery amount percentage breakdown

			among customers
GENERATOR_PERC	NUMBER(16,6)		Direction compensation recovery amount percentage breakdown among generators
LASTCHANGED	DATE		Last changed date time

9.10 Table: BILLING_EFTSHORTFALL_AMOUNT

9.10.1 BILLING_EFTSHORTFALL_AMOUNT

Name BILLING_EFTSHORTFALL_AMOUNT

Comment The billing shortfall run amounts

9.10.2 Description

BILLING_EFTSHORTFALL_AMOUNT data is confidential, and is available only to the relevant participant.

9.10.3 Notes

Name	Comment	Value
Visibility	Data in this table is:	Private

9.10.4 Primary Key Columns

Name

BILLRUNNO

CONTRACTYEAR

PARTICIPANTID

WEEKNO

9.10.5 Content

Name	Data Type	Mandatory	Comment
CONTRACTYEAR	NUMBER(4,0)	X	The shortfall affected billing contract year
WEEKNO	NUMBER(3,0)	X	The shortfall affected billing week

			no
BILLRUNNO	NUMBER(3,0)	X	The shortfall affected billing week run no
PARTICIPANTID	VARCHAR2(20)	X	The participant affected by the shortfall calculation
SHORTFALL_AMOUNT	NUMBER(18,8)		The Participant shortfall amount
SHORTFALL	NUMBER(18,8)		The market shortfall amount
SHORTFALL_COMPANY_ID	VARCHAR2(20)		The Company ID associated with the Participant ID used in the shortfall calculation
COMPANY_SHORTFALL_AMOUNT	NUMBER(18,8)		The shortfall amount for the Company ID associated with the Participant ID used in the shortfall calculation
PARTICIPANT_NET_ENERGY	NUMBER(18,8)		The participant NET energy used in shortfall calculation
COMPANY_NET_ENERGY	NUMBER(18,8)		The NET energy for the Company ID associated with the Participant ID used in the shortfall calculation

9.11 Table: BILLING_EFTSHORTFALL_DETAIL

9.11.1 BILLING_EFTSHORTFALL_DETAIL

Name BILLING_EFTSHORTFALL_DETAIL
 Comment The Billing Shortfall Run Amount details

9.11.2 Description

BILLING_EFTSHORTFALL_DETAIL data is confidential, and is available only to the relevant participant.

9.11.3 Notes

Name	Comment	Value
Visibility	Data in this table is:	Private & Public

9.11.4 Primary Key Columns

Name
 BILLRUNNO
 CONTRACTYEAR
 PARTICIPANTID
 TRANSACTION_TYPE
 WEEKNO

9.11.5 Content

Name	Data Type	Mandatory	Comment
CONTRACTYEAR	NUMBER(4,0)	X	The shortfall affected billing contract year

WEEKNO	NUMBER(3,0)	X	The shortfall affected billing week no
BILLRUNNO	NUMBER(3,0)	X	The shortfall affected billing week run no
PARTICIPANTID	VARCHAR2(20)	X	The participant affected by the shortfall calculation
TRANSACTION_TYPE	VARCHAR2(40)	X	The transaction type details associated with the shortfall calculation
AMOUNT	NUMBER(18,8)		The amount for each transaction type

9.12 Table: BILLING_GST_DETAIL

9.12.1 BILLING_GST_DETAIL

Name	BILLING_GST_DETAIL
Comment	BILLING_GST_DETAIL shows the BAS class, GST_Exclusive and GST amount (if any) attributable to a participant for each transaction type.

9.12.2 Description

BILLING_GST_DETAIL data is confidential to NSP participants.

Source

Populated by the posting of a billing run.

Volume

Approximately 20 records are inserted per billrunno, or about 220 records inserted per week.

9.12.3 Notes

Name	Comment	Value
Visibility	Data in this table is:	Private

9.12.4 Primary Key Columns

- Name
- BAS_CLASS
- BILLRUNNO
- CONTRACTYEAR
- PARTICIPANTID
- TRANSACTION_TYPE
- WEEKNO

9.12.5 Index Columns

Name

LASTCHANGED

9.12.6 Content

Name	Data Type	Mandatory	Comment
CONTRACTYEAR	NUMBER(4,0)	X	AEMO Contract Year number starting in week containing 1st January
WEEKNO	NUMBER(3,0)	X	Week no within the contract year. Week no 1 is the week containing 1st January
BILLRUNNO	NUMBER(3,0)	X	Unique run no within a given contract year and week no
PARTICIPANTID	VARCHAR2(10)	X	Unique participant identifier
BAS_CLASS	VARCHAR2(30)	X	The BAS classification that the transaction type belongs to.
TRANSACTION_TYPE	VARCHAR2(30)	X	The transaction type (e.g. CUSTOMER_ENERGY_PURCHASES)
GST_EXCLUSIVE_AMOUNT	NUMBER(15,5)		The GST exclusive amount paid by/to the participant to/by AEMO for this transaction type.
GST_AMOUNT	NUMBER(15,5)		The GST amount for this transaction type.
LASTCHANGED	DATE		Last date and time record changed

9.13 Table: BILLING_GST_SUMMARY

9.13.1 BILLING_GST_SUMMARY

Name	BILLING_GST_SUMMARY
Comment	BILLING_GST_SUMMARY shows the GST_Exclusive and GST amount (if any) attributable to a participant for each BAS class.

9.13.2 Description

BILLING_GST_SUMMARY data is confidential to NSP participants.

Source

Populated by the posting of a billing run.

Volume

Approximately 5 records are inserted per billrunno, or about 55 records inserted per week.

9.13.3 Notes

Name	Comment	Value
Visibility	Data in this table is:	Private

9.13.4 Primary Key Columns

Name

BAS_CLASS

BILLRUNNO

CONTRACTYEAR

PARTICIPANTID

WEEKNO

9.13.5 Index Columns

Name

LASTCHANGED

9.13.6 Content

Name	Data Type	Mandatory	Comment
CONTRACTYEAR	NUMBER(4,0)	X	AEMO Contract Year number starting in week containing 1st January
WEEKNO	NUMBER(3,0)	X	Week no within the contract year. Week no 1 is the week containing 1st January
BILLRUNNO	NUMBER(3,0)	X	Unique run no within a given contract year and week no
PARTICIPANTID	VARCHAR2(10)	X	Unique participant identifier
BAS_CLASS	VARCHAR2(30)	X	The BAS classification
GST_EXCLUSIVE_AMOUNT	NUMBER(15,5)		The GST exclusive amount paid by/to the participant to/by AEMO for this BAS classification.
GST_AMOUNT	NUMBER(15,5)		The GST amount for this BAS classification.
LASTCHANGED	DATE		Last date and time record changed

9.14 Table: BILLING_MR_PAYMENT

9.14.1 BILLING_MR_PAYMENT

Name	BILLING_MR_PAYMENT
Comment	BILLING_MR_PAYMENT shows aggregate payments on a dispatchable unit/MR Event basis for accepted MR capacity

9.14.2 Description

BILLING_MR_PAYMENT data is confidential, and is available only to the relevant participant.

Source

Ad hoc - MR events only.

Volume

3500 rows per year

9.14.3 Notes

Name	Comment	Value
Visibility	Data in this table is:	Private

9.14.4 Primary Key Columns

Name
 BILLRUNNO
 CONTRACTYEAR
 DUID
 MR_DATE
 REGIONID
 WEEKNO

9.14.5 Index Columns

Name

LASTCHANGED

9.14.6 Content

Name	Data Type	Mandatory	Comment
CONTRACTYEAR	NUMBER(4,0)	X	Billing Contract Year
WEEKNO	NUMBER(3,0)	X	Billing Week number
BILLRUNNO	NUMBER(3,0)	X	Billing Run number
MR_DATE	DATE	X	Trading Date of Mandatory Restriction event; Mandatory Restriction imposition date
REGIONID	VARCHAR2(10)	X	Unique Region Identifier
PARTICIPANTID	VARCHAR2(10)		Unique Participant identifier
DUID	VARCHAR2(10)	X	Unique identifier for DUID / MNSP LinkID
MR_AMOUNT	NUMBER(16,6)		Payment amount by AEMO
LASTCHANGED	DATE		Date/Time record inserted/modified

9.15 Table: BILLING_MR_RECOVERY

9.15.1 BILLING_MR_RECOVERY

Name	BILLING_MR_RECOVERY
Comment	BILLING_MR_RECOVERY shows aggregate recovery charges on a dispatchable unit / MR Event basis for spot market income from dispatch of MR capacity.

9.15.2 Description

BILLING_MR_RECOVERY data is confidential, and is available only to the relevant participant.

Source

Ad hoc - MR events only.

Volume

3500 rows per year

9.15.3 Notes

Name	Comment	Value
Visibility	Data in this table is:	Private

9.15.4 Primary Key Columns

- Name
- BILLRUNNO
- CONTRACTYEAR
- DUID
- MR_DATE
- REGIONID
- WEEKNO

9.15.5 Index Columns

Name

LASTCHANGED

9.15.6 Content

Name	Data Type	Mandatory	Comment
CONTRACTYEAR	NUMBER(4,0)	X	Billing Contract Year
WEEKNO	NUMBER(3,0)	X	Billing Week number
BILLRUNNO	NUMBER(3,0)	X	Billing Run number
MR_DATE	DATE	X	Trading Date of Mandatory Restriction event; Mandatory Restriction imposition date
REGIONID	VARCHAR2(10)	X	Unique Region Identifier
PARTICIPANTID	VARCHAR2(10)		Unique Participant identifier
DUID	VARCHAR2(10)	X	Unique identifier for DUID / MNSP LinkID
MR_AMOUNT	NUMBER(16,6)		Payment amount to AEMO
LASTCHANGED	DATE		Date/Time record inserted/modified

9.16 Table: BILLING_MR_SHORTFALL

9.16.1 BILLING_MR_SHORTFALL

Name	BILLING_MR_SHORTFALL
Comment	BILLING_MR_SHORTFALL shows aggregate MR shortfall payments (or recovery charges) to each participant in the region for the MR event.

9.16.2 Description

BILLING_MR_SHORTFALL data is confidential, and is available only to the relevant participant.

Source

Ad hoc - MR events only.

Volume

400 rows per year.

9.16.3 Notes

Name	Comment	Value
Visibility	Data in this table is:	Private

9.16.4 Primary Key Columns

- Name
- BILLRUNNO
- CONTRACTYEAR
- MR_DATE
- PARTICIPANTID
- REGIONID
- WEEKNO

9.16.5 Index Columns

Name

LASTCHANGED

9.16.6 Content

Name	Data Type	Mandatory	Comment
CONTRACTYEAR	NUMBER(4,0)	X	Billing Contract Year
WEEKNO	NUMBER(3,0)	X	Billing Week number
BILLRUNNO	NUMBER(3,0)	X	Billing Run number
MR_DATE	DATE	X	Trading Date of Mandatory Restriction event; Mandatory Restriction imposition date
REGIONID	VARCHAR2(10)	X	Unique Region Identifier
PARTICIPANTID	VARCHAR2(10)	X	Unique Participant Identifier
AGE	NUMBER(16,6)		The adjusted gross energy for the market customer in the restricted region for the duration of the mandatory restriction event (MWh)
RSA	NUMBER(16,6)		Restriction Shortfall amount payable to AEMO for a mandatory restriction period
LASTCHANGED	DATE		Date/Time record inserted/modified

9.17 Table: BILLING_MR_SUMMARY

9.17.1 BILLING_MR_SUMMARY

Name	BILLING_MR_SUMMARY
Comment	BILLING_MR_SUMMARY shows aggregate payment/recovery and shortfall figures for an MR Event.

9.17.2 Description

BILLING_MR_SUMMARY data is public to all participants.

Source

Ad hoc - MR events only.

Volume

200 rows per year.

9.17.3 Notes

Name	Comment	Value
Visibility	Data in this table is:	Public

9.17.4 Primary Key Columns

Name

BILLRUNNO

CONTRACTYEAR

MR_DATE

REGIONID

WEEKNO

9.17.5 Index Columns

Name

LASTCHANGED

9.17.6 Content

Name	Data Type	Mandatory	Comment
CONTRACTYEAR	NUMBER(4,0)	X	Billing Contract Year
WEEKNO	NUMBER(3,0)	X	Billing Week number
BILLRUNNO	NUMBER(3,0)	X	Billing Run number
MR_DATE	DATE	X	Trading Date of Mandatory Restriction event; Mandatory Restriction imposition date
REGIONID	VARCHAR2(10)	X	Unique Region Identifier
TOTAL_PAYMENTS	NUMBER(16,6)		Total payments by AEMO
TOTAL_RECOVERY	NUMBER(16,6)		Total payments to AEMO
TOTAL_RSA	NUMBER(16,6)		Total Restriction Shortfall Amount
AAGE	NUMBER(16,6)		The aggregate of then adjusted gross energy of all the market customer in the restricted region for the duration of the mandatory restriction period (MWh)
LASTCHANGED	DATE		Date/Time record inserted/modified

9.18 Table: BILLING_NMAS_TST_PAYMENTS

9.18.1 BILLING_NMAS_TST_PAYMENTS

Name	BILLING_NMAS_TST_PAYMENTS
Comment	BILLING_NMAS_TEST_PAYMENTS publish the NSCAS/SRAS Testing Payments data for a posted billing week.

9.18.2 Notes

Name	Comment	Value
Visibility	Data in this table is:	Private

9.18.3 Primary Key Columns

Name

BILLRUNNO

CONTRACTID

CONTRACTYEAR

PARTICIPANTID

SERVICE

WEEKNO

9.18.4 Content

Name	Data Type	Mandatory	Comment
CONTRACTYEAR	NUMBER(4,0)	X	AEMO Contract Year number starting in week containing 1 January

WEEKNO	NUMBER(3,0)	X	Week no within the contract year. Week no 1 is the week containing 1 January
BILLRUNNO	NUMBER(3,0)	X	The current Billing RunNo for the week
PARTICIPANTID	VARCHAR(20)	X	The Participant from whom the amount is recovered
SERVICE	VARCHAR(10)	X	The type of NSCAS service. Current value values are: - REACTIVE - LOADSHED
CONTRACTID	VARCHAR(10)	X	The NMAS Contract Id
PAYMENT_AMOUNT	NUMBER(18,8)		The Testing Payment Amount to recover

9.19 Table: BILLING_NMAS_TST_RECOVERY

9.19.1 BILLING_NMAS_TST_RECOVERY

Name	BILLING_NMAS_TST_RECOVERY
Comment	BILLING_NMAS_TEST_RECOVERY sets out the recovery of NMAS testing payments

9.19.2 Notes

Name	Comment	Value
Visibility	Data in this table is:	Private

9.19.3 Primary Key Columns

Name

BILLRUNNO

CONTRACTID

CONTRACTYEAR

PARTICIPANTID

REGIONID

SERVICE

WEEKNO

9.19.4 Index Columns

Name

LASTCHANGED

9.19.5 Content

Name	Data Type	Mandatory	Comment
CONTRACTYEAR	NUMBER(4,0)	X	AEMO Contract Year number starting in week containing 1 January
WEEKNO	NUMBER(3,0)	X	Week no within the contract year. Week no 1 is the week containing 1 January
BILLRUNNO	NUMBER(3,0)	X	The current Billing RunNo for the week
PARTICIPANTID	VARCHAR(20)	X	The Participant from whom the amount is recovered
SERVICE	VARCHAR(10)	X	The type of NSCAS service. Current value values are: - REACTIVE - LOADSHED - RESTART
CONTRACTID	VARCHAR(10)	X	The NMAS Contract Id
REGIONID	VARCHAR(10)	X	The region from where the amount is recovered
RBF	NUMBER(18,8)		The Benefitting Factor for the RegionId
TEST_PAYMENT	NUMBER(18,8)		The total Testing Payment Amount to recover from all benefitting regions
RECOVERY_START_DATE	DATE		The Recovery Start Date for the Testing Payment Calculation

RECOVERY_END_DATE	DATE		The Recovery End Date for the Testing Payment Calculation
PARTICIPANT_ENERGY	NUMBER(18,8)		The Participant energy in MWh for the recovery period
REGION_ENERGY	NUMBER(18,8)		The RegionId energy in MWh for the recovery period
NEM_ENERGY	NUMBER(18,8)		The NEM energy in MWh for the recovery period
CUSTOMER_PROPORTION	NUMBER(18,8)		The Customer Proportion for recovery amount in Percent
GENERATOR_PROPORTION	NUMBER(18,8)		The Generator Proportion for recovery amount in Percent (100-Customer Portion)
PARTICIPANT_GENERATION	NUMBER(18,8)		The Participant Generation for the recovery period
NEM_GENERATION	NUMBER(18,8)		The NEM Generation for the recovery period
RECOVERY_AMOUNT	NUMBER(18,8)		The Total recovery amount for the billing week, being the sum of the customer and generator proportions for the PARTICIPANTID in REGIONID
LASTCHANGED	DATE		The Last Updated date and time

9.20 Table: BILLING_NMAS_TST_RECVRY_RBF

9.20.1 BILLING_NMAS_TST_RECVRY_RBF

Name	BILLING_NMAS_TST_RECVRY_RBF
Comment	BILLING_NMAS_TEST_RECVRY_RBF sets out the NSCAS/SRAS Testing Payment recovery data for the posted billing week.

9.20.2 Notes

Name	Comment	Value
Visibility	Data in this table is:	Public

9.20.3 Primary Key Columns

Name

BILLRUNNO

CONTRACTID

CONTRACTYEAR

REGIONID

SERVICE

WEEKNO

9.20.4 Index Columns

Name

LASTCHANGED

9.20.5 Content

Name	Data Type	Mandatory	Comment
CONTRACTYEAR	NUMBER(4,0)	X	AEMO Contract Year number starting in week containing 1 January
WEEKNO	NUMBER(3,0)	X	Week no within the contract year. Week no 1 is the week containing 1 January
BILLRUNNO	NUMBER(3,0)	X	The current Billing RunNo for the week
SERVICE	VARCHAR(10)	X	The type of NSCAS service. Current value values are: - REACTIVE - LOADSHED
CONTRACTID	VARCHAR(10)	X	The NMAS Contract Id
REGIONID	VARCHAR(10)	X	The region from where the amount is recovered
RBF	NUMBER(18,8)		The Benefitting Factor for the RegionId
PAYMENT_AMOUNT	NUMBER(18,8)		The total Testing Payment Amount to recover from all benefitting regions
RECOVERY_AMOUNT	NUMBER(18,8)		The Testing Payment amount to recover from RegionId
LASTCHANGED	DATE		The Last Updated date and time

9.21 Table: BILLING_NMAS_TST_RECVRV_TRK

9.21.1 BILLING_NMAS_TST_RECVRV_TRK

Name BILLING_NMAS_TST_RECVRV_TRK

Comment BILLING_NMAS_TEST_RECVRV_TRK tracks the energy data used to allocate the test payment recovery over the recovery period.

9.21.2 Notes

Name	Comment	Value
Visibility	Data in this table is:	Public

9.21.3 Primary Key Columns

Name

BILLRUNNO

CONTRACTYEAR

RECOVERY_BILLRUNNO

RECOVERY_CONTRACTYEAR

RECOVERY_WEEKNO

WEEKNO

9.21.4 Content

Name	Data Type	Mandatory	Comment
CONTRACTYEAR	NUMBER(4,0)	X	AEMO Contract Year number starting in week containing 1 January

WEEKNO	NUMBER(3,0)	X	Week no within the contract year. Week no 1 is the week containing 1 January
BILLRUNNO	NUMBER(3,0)	X	The current Billing RunNo for the week
RECOVERY_CONTRACTYEAR	NUMBER(4,0)	X	AEMO Contract Year for energy data used in recovery calculation
RECOVERY_WEEKNO	NUMBER(3,0)	X	Week no for energy data used in recovery calculation
RECOVERY_BILLRUNNO	NUMBER(3,0)	X	Billing RunNo for energy data used in recovery calculation

9.22 Table: BILLING_RES_TRADER_PAYMENT

9.22.1 BILLING_RES_TRADER_PAYMENT

Name BILLING_RES_TRADER_PAYMENT
 Comment Billing result table for reserve trader contract payments

9.22.2 Notes

Name Comment Value
 Visibility Data in this table is: Private

9.22.3 Primary Key Columns

Name
 BILLRUNNO
 CONTRACTID
 CONTRACTYEAR
 PARTICIPANTID
 PAYMENT_TYPE
 WEEKNO

9.22.4 Content

Name	Data Type	Mandatory	Comment
CONTRACTYEAR	NUMBER(4)	X	Billing contract year
WEEKNO	NUMBER(3)	X	Billing week number
BILLRUNNO	NUMBER(3)	X	Billing run number

CONTRACTID	VARCHAR2(20)	X	Reserve trader contract identifier
PAYMENT_TYPE	VARCHAR2(40)	X	Payment type for the reserve trader contract payment amount
PARTICIPANTID	VARCHAR2(20)	X	Participant identifier associated with the contract
PAYMENT_AMOUNT	NUMBER(18,8)		Payment amount to the participant

9.23 Table: BILLING_RES_TRADER_RECOVERY

9.23.1 BILLING_RES_TRADER_RECOVERY

Name BILLING_RES_TRADER_RECOVERY

Comment Billing result table for reserve trader contract recovery

9.23.2 Notes

Name Comment Value

Visibility Data in this table is: Private

9.23.3 Primary Key Columns

Name

BILLRUNNO

CONTRACTYEAR

PARTICIPANTID

REGIONID

WEEKNO

9.23.4 Content

Name	Data Type	Mandatory	Comment
CONTRACTYEAR	NUMBER(4)	X	Billing contract year
WEEKNO	NUMBER(3)	X	Billing week number
BILLRUNNO	NUMBER(3)	X	Billing run number
REGIONID	VARCHAR2(20)	X	Region id for the aggregated

)		recovery amount
PARTICIPANTID	VARCHAR2(20)	X	Participant identifier
RECOVERY_AMOUNT	NUMBER(18,8)		Payment amount to be recovered from the participant

9.24 Table: BILLING_SECDEP_INTEREST_PAY

9.24.1 BILLING_SECDEP_INTEREST_PAY

Name	BILLING_SECDEP_INTEREST_PAY
Comment	The interest amount for security deposit calculated by billing, based on whether it is a fixed/floating rate

9.24.2 Description

BILLING_SECDEP_INTEREST_PAY data is confidential, and is available only to the relevant participant.

9.24.3 Notes

Name	Comment	Value
Visibility	Data in this table is:	Private

9.24.4 Primary Key Columns

Name

BILLRUNNO

CONTRACTYEAR

PARTICIPANTID

SECURITY_DEPOSIT_ID

WEEKNO

9.24.5 Content

Name	Data Type	Mandatory	Comment
CONTRACTYEAR	NUMBER(4,0)	X	The billing contract year the SDA

			application is processed and interest calculated
WEEKNO	NUMBER(3,0)	X	The billing week no. the SDA application is processed and interest calculated
BILLRUNNO	NUMBER(3,0)	X	The billing run no. the SDA application is processed and interest calculated
SECURITY_DEPOSIT_ID	VARCHAR2(20)	X	The security deposit ID for which billing has calculated the Interest amount
PARTICIPANTID	VARCHAR2(20)	X	The participant ID of the security deposit for whom the interest is paid
INTEREST_AMOUNT	NUMBER(18,8)		The security deposit interest amount calculated by billing
INTEREST_CALC_TYPE	VARCHAR2(20)		FIXED or DAILY
INTEREST_ACCT_ID	VARCHAR2(20)		The interest account ID used by billing for calculating the interest. NULL if INTEREST_CALC_TYPE = FIXED
INTEREST_RATE	NUMBER(18,8)		The STATIC Interest Rate used by Billing for calculating the interest. This is NULL if INTEREST_CALC_TYPE <> FIXED

9.25 Table: BILLING_SECDEP_INTEREST_RATE

9.25.1 BILLING_SECDEP_INTEREST_RATE

Name	BILLING_SECDEP_INTEREST_RATE
Comment	The DAILY interest rates used by billing when calculating the interest amount

9.25.2 Notes

Name	Comment	Value
Visibility	Data in this table is:	Public

9.25.3 Primary Key Columns

Name

BILLRUNNO

CONTRACTYEAR

EFFECTIVEDATE

INTEREST_ACCT_ID

WEEKNO

9.25.4 Content

Name	Data Type	Mandatory	Comment
CONTRACTYEAR	NUMBER(4,0)	X	The billing contract year the SDA application is processed and interest calculated
WEEKNO	NUMBER(3,0)	X	The billing week no. the SDA application is processed and

			interest calculated
BILLRUNNO	NUMBER(3,0)	X	The billing run no. the SDA application is processed and interest calculated
INTEREST_ACCT_ID	VARCHAR2(20)	X	The interest account ID used by security deposit interest calculation
EFFECTIVEDATE	DATE	X	The effective date of the new interest change
INTEREST_RATE	NUMBER(18,8)		The interest rate to apply from the effective date

9.26 Table: BILLING_SECDEPOSIT_APPLICATION

9.26.1 BILLING_SECDEPOSIT_APPLICATION

Name	BILLING_SECDEPOSIT_APPLICATION
Comment	The security deposit application details

9.26.2 Description

BILLING_SECDEPOSIT_APPLICATION data is confidential, and is available only to the relevant participant.

9.26.3 Notes

Name	Comment	Value
Visibility	Data in this table is:	Private

9.26.4 Primary Key Columns

Name

BILLRUNNO

CONTRACTYEAR

PARTICIPANTID

WEEKNO

9.26.5 Content

Name	Data Type	Mandatory	Comment
CONTRACTYEAR	NUMBER(4,0)	X	The billing contract year where (security deposit application) SDA is applied

WEEKNO	NUMBER(3,0)	X	The billing week no. where the SDA is applied
BILLRUNNO	NUMBER(3,0)	X	The billing run no. where the SDA is applied
PARTICIPANTID	VARCHAR2(20)	X	The Participant ID lodging the SDA
APPLICATION_AMOUNT	NUMBER(18,8)		The SDA application amount

9.27 Table: BILLINGAPCCOMPENSATION

9.27.1 BILLINGAPCCOMPENSATION

Name	BILLINGAPCCOMPENSATION
Comment	BILLINGAPCCOMPENSATION shows Administered Price Cap (APC) compensation amounts for the billing period. Data is for each participant by region.

9.27.2 Description

Updated with each billing run

9.27.3 Notes

Name	Comment	Value
Visibility	Data in this table is:	Private

9.27.4 Primary Key Columns

Name
 BILLRUNNO
 CONTRACTYEAR
 PARTICIPANTID
 REGIONID
 WEEKNO

9.27.5 Index Columns

Name
 LASTCHANGED

9.27.6 Content

Name	Data Type	Mandatory	Comment
CONTRACTYEAR	NUMBER(4,0)	X	AEMO Contract Year number starting in week containing 1st January
WEEKNO	NUMBER(3,0)	X	Week no within the contract year. Week no 1 is the week containing 1st January
BILLRUNNO	NUMBER(3,0)	X	Unique run no within a given contract year and week no
PARTICIPANTID	VARCHAR2(10)	X	Unique participant identifier
REGIONID	VARCHAR2(10)	X	Region Identifier
APCCOMPENSATION	NUMBER(15,5)		APC Compensation
LASTCHANGED	DATE		Last changed date and time

9.28 Table: BILLINGAPCRECOVERY

9.28.1 BILLINGAPCRECOVERY

Name	BILLINGAPCRECOVERY
Comment	BILLINGAPCRECOVERY shows the Administered Price Cap (APC) Recovery for the billing period. Data is for each participant by region.

9.28.2 Description

Source

Obsolete; was updated weekly with each billing run.

9.28.3 Notes

Name	Comment	Value
Visibility	Data in this table is:	Private

9.28.4 Primary Key Columns

Name

BILLRUNNO

CONTRACTYEAR

PARTICIPANTID

REGIONID

WEEKNO

9.28.5 Index Columns

Name

LASTCHANGED

9.28.6 Content

Name	Data Type	Mandatory	Comment
CONTRACTYEAR	NUMBER(4,0)	X	Contract year
WEEKNO	NUMBER(3,0)	X	Billing week
BILLRUNNO	NUMBER(3,0)	X	Billing run number
PARTICIPANTID	VARCHAR2(10))	X	Participant identifier
REGIONID	VARCHAR2(10))	X	Region Identifier
APCRECOVERY	NUMBER(15,0)		APC Recovery amount for week
LASTCHANGED	DATE		Last date and time record changed

9.29 Table: BILLINGASPAYMENTS

9.29.1 BILLINGASPAYMENTS

Name	BILLINGASPAYMENTS
Comment	BILLINGASPAYMENTS shows Ancillary Service payments for each billing period by each of the Ancillary Service types for each participant's connection points.

9.29.2 Description

BILLINGASPAYMENTS data is confidential to relevant participant.

Source

Updated with each billing run.

Volume

The volume is according to the number of Transmission ConnectionPointIDs a Participant may have subject to ancillary payment per billrunno. An indicative maximum is approximately 20 records are inserted per billrunno, or about 220 records inserted per week.

9.29.3 Notes

Name	Comment	Value
Visibility	Data in this table is:	Private

9.29.4 Primary Key Columns

Name
 BILLRUNNO
 CONNECTIONPOINTID
 CONTRACTYEAR
 PARTICIPANTID
 WEEKNO

9.29.5 Index Columns

Name

LASTCHANGED

9.29.6 Content

Name	Data Type	Mandatory	Comment
REGIONID	VARCHAR2(10)		Region Identifier
CONTRACTYEAR	NUMBER(4,0)	X	Contract Year
WEEKNO	NUMBER(3,0)	X	Week No
BILLRUNNO	NUMBER(3,0)	X	Billing Run No.
PARTICIPANTID	VARCHAR2(10)	X	Participant Identifier
CONNECTIONPOINTID	VARCHAR2(10)	X	Connection point identifier
RAISE6SEC	NUMBER(15,5)		Raise 6 Sec Payments
LOWER6SEC	NUMBER(15,5)		Lower 6 Sec Payments
RAISE60SEC	NUMBER(15,5)		Raise 60 Sec Payments
LOWER60SEC	NUMBER(15,5)		Lower 60 Sec Payments
AGC	NUMBER(15,5)		AGC Payments
FCASCOMP	NUMBER(15,5)		Frequency Control Compensation Payments
LOADSHED	NUMBER(15,5)		Load Shed Payments

RGUL	NUMBER(15,5)		Rapid Generator unit Loading Payments
RGUU	NUMBER(15,5)		Rapid Generator Unit Unloading Payments
REACTIVEPOWER	NUMBER(15,5)		Reactive Power Payments
SYSTEMRESTART	NUMBER(15,5)		System Restart Payments
LASTCHANGED	DATE		The latest date and time that a file was updated or inserted
LOWER5MIN	NUMBER(15,5)		Lower 5 Minute Payment
RAISE5MIN	NUMBER(15,5)		Raise 5 Minute Payment
LOWERREG	NUMBER(15,5)		Lower 5 Minute Regulation Payment
RAISEREG	NUMBER(15,5)		Raise 5 Minute Regulation Payment
AVAILABILITY_REACTIVE	NUMBER(18,8)		The total availability payment
AVAILABILITY_REACTIVE_RBT	NUMBER(18,8)		The total availability payment rebate

9.30 Table: BILLINGASRECOVERY

9.30.1 BILLINGASRECOVERY

Name	BILLINGASRECOVERY
Comment	BILLINGASRECOVERY shows participant charges for Ancillary Services for the billing period. This view shows the billing amounts for Ancillary Service Recovery.

9.30.2 Description

BILLINGASRECOVERY data is confidential to relevant participant.

Source

Updated with each billing run.

Volume

Approximately 5 records are inserted per billrunno, or about 55 records inserted per week.

9.30.3 Notes

Name	Comment	Value
Visibility	Data in this table is:	Private

9.30.4 Primary Key Columns

- Name
- BILLRUNNO
- CONTRACTYEAR
- PARTICIPANTID
- REGIONID
- WEEKNO

9.30.5 Index Columns

Name

LASTCHANGED

9.30.6 Content

Name	Data Type	Mandatory	Comment
REGIONID	VARCHAR2(10)	X	Region Identifier
CONTRACTYEAR	NUMBER(4,0)	X	Contract Year
WEEKNO	NUMBER(3,0)	X	Week No
BILLRUNNO	NUMBER(3,0)	X	Billing Run No.
PARTICIPANTID	VARCHAR2(10)	X	Participant Identifier
RAISE6SEC	NUMBER(15,5)		Raise 6 Sec Recovery
LOWER6SEC	NUMBER(15,5)		Lower 6 Sec Recovery
RAISE60SEC	NUMBER(15,5)		Raise 60 Sec Recovery
LOWER60SEC	NUMBER(15,5)		Lower 60 Sec Recovery
AGC	NUMBER(15,5)		AGC Recovery - Not used since circa 2000
FCASCOMP	NUMBER(15,5)		Frequency Control Compensation Recovery - Not used since circa 2000
LOADSHED	NUMBER(15,5)		Load Shed Recovery
RGUL	NUMBER(15,5)		Rapid Generator Unit Loading Recovery - Not used since

			December 2001
RGUU	NUMBER(15,5)		Rapid Generator Unit Unloading Recovery - Not used since December 2001
REACTIVEPOWER	NUMBER(15,5)		Reactive Power Recovery
SYSTEMRESTART	NUMBER(15,5)		System Restart Recovery
LASTCHANGED	DATE		The latest date and time a file was updated/inserted
RAISE6SEC_GEN	NUMBER(15,5)		Raise 6 Sec Recovery for Generator
LOWER6SEC_GEN	NUMBER(15,5)		Lower 6 Sec Recovery for Generator
RAISE60SEC_GEN	NUMBER(15,5)		Raise 60 Sec Recovery for Generator
LOWER60SEC_GEN	NUMBER(15,5)		Lower 60 Sec Recovery for Generator
AGC_GEN	NUMBER(15,5)		AGC Recovery for Generator
FCASCOMP_GEN	NUMBER(15,5)		Frequency Control Compensation Recovery for Generator
LOADSHED_GEN	NUMBER(15,5)		Load Shed Recovery for Generator
RGUL_GEN	NUMBER(15,5)		Rapid Generator unit Loading Recovery for. Generator - Not used since December 2001
RGUU_GEN	NUMBER(15,5)		Rapid Generator Unit Unloading Recovery for Generator - Not used since December 2001
REACTIVEPOWER_GEN	NUMBER(15,5)		Reactive Power Recovery for Generator
SYSTEMRESTART_GEN	NUMBER(15,5)		System Restart Recovery for

			Generator
LOWER5MIN	NUMBER(15,5)		Recovery amount for the Lower 5 Minute service attributable to customer connection points
RAISE5MIN	NUMBER(15,5)		Recovery amount for the Raise 5 Minute service attributable to customer connection points
LOWERREG	NUMBER(15,5)		Recovery amount for the Lower Regulation service attributable to customer connection points
RAISEREG	NUMBER(15,5)		Recovery amount for the Raise Regulation Second service attributable to customer connection points
LOWER5MIN_GEN	NUMBER(16,6)		Recovery amount for the Lower 5 Minute service attributable to generator connection points
RAISE5MIN_GEN	NUMBER(16,6)		Recovery amount for the Raise 5 Minute service attributable to generator connection points
LOWERREG_GEN	NUMBER(16,6)		Recovery amount for the Lower Regulation service attributable to generator connection points
RAISEREG_GEN	NUMBER(16,6)		Recovery amount for the Raise Regulation Second service attributable to generator connection points
AVAILABILITY_REACTIVE	NUMBER(18,8)		The total availability payment recovery amount (customer).
AVAILABILITY_REACTIVE_RBT	NUMBER(18,8)		The total availability payment rebate recovery amount (customer).

AVAILABILITY_REACTIVE_G EN	NUMBER(18,8)		The total availability payment recovery amount (Generator).
AVAILABILITY_REACTIVE_R BT_GEN	NUMBER(18,8)		The total availability payment rebate recovery amount (Generator).

9.31 Table: BILLINGCPDATA

9.31.1 BILLINGCPDATA

Name	BILLINGCPDATA
Comment	BILLINGCPDATA shows energy quantity and \$ value purchased per participant connection point.

9.31.2 Description

BILLINGCPDATA data is confidential to relevant participant.

Source

Populated by the posting of a billing run, being several times each week.

Volume

The number of records depends on the number of Transmission ConnectionPointIDs a participant may use to purchase energy. An indicative maximum is approximately 150 records per billrunno, or about 1,500 records inserted per week.

9.31.3 Notes

Name	Comment	Value
Visibility	Data in this table is:	Private

9.31.4 Primary Key Columns

- Name
- BILLRUNNO
- CONNECTIONPOINTID
- CONTRACTYEAR
- MDA
- PARTICIPANTID

WEEKNO

9.31.5 Index Columns

Name

LASTCHANGED

9.31.6 Index Columns

Name

PARTICIPANTID

9.31.7 Content

Name	Data Type	Mandatory	Comment
CONTRACTYEAR	NUMBER(4,0)	X	AEMO Contract Year number starting in week containing 1st January
WEEKNO	NUMBER(3,0)	X	Week no within the contract year. Week no 1 is the week containing 1st January
BILLRUNNO	NUMBER(3,0)	X	Unique run no within a given contract year and week no
PARTICIPANTID	VARCHAR2(10)	X	Unique participant identifier
CONNECTIONPOINTID	VARCHAR2(10)	X	Unique connection point identifier
AGGREGATEENERGY	NUMBER(16,6)		Aggregate energy purchased/sold by customer, in MWh

PURCHASES	NUMBER(16,6)		Value of energy purchased/sold by customer, in \$
LASTCHANGED	DATE		Last date and time record changed
MDA	VARCHAR2(10)	X	relevant MDA for this connection point.

9.32 Table: BILLINGDAYTRK

9.32.1 BILLINGDAYTRK

Name	BILLINGDAYTRK
Comment	BILLINGDAYTRK is key for matching settlement versions with billing runs. BILLINGDAYTRK displays the billrunnos per billing week, and the settlement version numbers per settlement day comprising the billrunno.

9.32.2 Description

BILLINGDAYTRK is public data, and is available to all participants.

Source

BILLINGDAYTRK is populated by the posting of a billing run, being several times each week.

Volume

Each billing run inserts approximately 7 records, being about 77 records per week.

9.32.3 Notes

Name	Comment	Value
Visibility	Data in this table is:	Public

9.32.4 Primary Key Columns

- Name
- BILLRUNNO
- CONTRACTYEAR
- SETTLEMENTDATE
- WEEKNO

9.32.5 Index Columns

Name

LASTCHANGED

9.32.6 Content

Name	Data Type	Mandatory	Comment
CONTRACTYEAR	NUMBER(4,0)	X	AEMO Contract Year number starting in week containing 1st January
WEEKNO	NUMBER(3,0)	X	Week no within the contract year. Week no 1 is the week containing 1st January
BILLRUNNO	NUMBER(3,0)	X	Unique run no within a given contract year and week no
SETTLEMENTDATE	DATE	X	Calendar Settlement Date contained in the billing run.
RUNNO	NUMBER(3,0)		Settlement run number used for each settlement date in that billing run.
LASTCHANGED	DATE		Last date and time record changed

9.33 Table: BILLINGFEES

9.33.1 BILLINGFEES

Name	BILLINGFEES
Comment	BILLINGFEES presents pool fees applied to the statement, per billing run.

9.33.2 Description

BILLINGFEES data is confidential to the relevant participant.

Source

BILLINGFEES is populated by the posting of a billing run, being several times each week.

Volume

The number of records varies according to the number of pool fee types the participant may be subject to. An indicative maximum is about 13 records inserted per billrunno or 143 records inserted per week.

9.33.3 Notes

Name	Comment	Value
Visibility	Data in this table is:	Private

9.33.4 Primary Key Columns

Name

BILLRUNNO

CONTRACTYEAR

MARKETFEEID

PARTICIPANTCATEGORYID

PARTICIPANTID

WEEKNO

9.33.5 Index Columns

Name

LASTCHANGED

9.33.6 Index Columns

Name

PARTICIPANTID

9.33.7 Content

Name	Data Type	Mandatory	Comment
CONTRACTYEAR	NUMBER(4,0)	X	AEMO Contract Year number starting in week containing 1st January
WEEKNO	NUMBER(3,0)	X	Week no within the contract year. Week no 1 is the week containing 1st January
BILLRUNNO	NUMBER(3,0)	X	Unique run no within a given contract year and week no
PARTICIPANTID	VARCHAR2(10)	X	Unique participant identifier
MARKETFEEID	VARCHAR2(10)	X	Market fee identifier
RATE	NUMBER(15,5)		Market fee rate
ENERGY	NUMBER(16,6)		Energy, in MWh

VALUE	NUMBER(15,5)		Fee in \$
LASTCHANGED	DATE		Last date and time record changed
PARTICIPANTCATEGORYID	VARCHAR2(10)	X	The participant category pertaining to the market fee recovery. Corresponds to the PARTICIPANTCATEGORYID column of the SETMARKETFEEES table.

9.34 Table: BILLINGFINANCIALADJUSTMENTS

9.34.1 BILLINGFINANCIALADJUSTMENTS

Name	BILLINGFINANCIALADJUSTMENTS
Comment	BILLINGFINANCIALADJUSTMENTS contains any manual adjustments included in the billing run.

9.34.2 Description

BILLINGFINANCIALADJUSTMENTS data is confidential to the relevant participant.

Source

BILLINGFINANCIALADJUSTMENTS is populated by the posting of a billing run, being several times each week. The insertion of a manual adjustment in a billing run is infrequent.

Volume

Infrequent and, if included in a billing run, low volume. An indicative maximum is 15 records inserted.

9.34.3 Notes

Name	Comment	Value
Visibility	Data in this table is:	Private

9.34.4 Primary Key Columns

Name
 ADJUSTMENTITEM
 BILLRUNNO
 CONTRACTYEAR
 PARTICIPANTID
 WEEKNO

9.34.5 Index Columns

Name

LASTCHANGED

9.34.6 Content

Name	Data Type	Mandatory	Comment
CONTRACTYEAR	NUMBER(4,0)	X	AEMO Contract Year number starting in week containing 1st January
WEEKNO	NUMBER(3,0)	X	Week no within the contract year. Week no 1 is the week containing 1st January
BILLRUNNO	NUMBER(3,0)	X	Unique run no within a given contract year and week no
PARTICIPANTID	VARCHAR2(10)	X	Unique participant identifier
PARTICIPANTTYPE	VARCHAR2(10)		Not Used
ADJUSTMENTITEM	VARCHAR2(64)	X	Description of the adjustment being made
AMOUNT	NUMBER(15,5)		The amount of the manual adjustment line item
VALUE	NUMBER(15,5)		Not Used
LASTCHANGED	DATE		Last date and time the record changed.
FINANCIALCODE	NUMBER(10,0)		The GL financial code of the manual adjustment line item. Used internally by AEMO systems.

BAS_CLASS	VARCHAR2(30)		The BAS classification of the manual adjustment line item.
-----------	------------------	--	--

9.35 Table: BILLINGGENDATA

9.35.1 BILLINGGENDATA

Name	BILLINGGENDATA
Comment	BILLINGGENDATA shows the total energy sold and purchased per participant transmission connection point for a billing period.

9.35.2 Description

BILLINGGENDATA data is confidential to the the relevant participant.

Source

BILLINGGENDATA is populated by the posting of a billing run, being several times each week.

Volume

The number of records depends on the number of transmission ConnectionPointIDs a Participant may have sold energy from per billrunno. An indicative maximum is approximately 15 records inserted per billrunno, or about 165 records inserted per week.

BILLINGGENDATA is confidential to the the relevant participant.

9.35.3 Notes

Name	Comment	Value
Visibility	Data in this table is:	Private

9.35.4 Primary Key Columns

- Name
- BILLRUNNO
- CONNECTIONPOINTID
- CONTRACTYEAR
- PARTICIPANTID
- WEEKNO

9.35.5 Index Columns

Name

LASTCHANGED

9.35.6 Index Columns

Name

PARTICIPANTID

9.35.7 Content

Name	Data Type	Mandatory	Comment
CONTRACTYEAR	NUMBER(4,0)	X	AEMO Contract Year number starting in week containing 1st January
WEEKNO	NUMBER(3,0)	X	Week no within the contract year. Week no 1 is the week containing 1st January
BILLRUNNO	NUMBER(3,0)	X	Unique run no within a given contract year and week no
PARTICIPANTID	VARCHAR2(10)	X	Unique participant identifier
CONNECTIONPOINTID	VARCHAR2(10)	X	Connection point identifier
STATIONID	VARCHAR2(10)		not populated
DUID	VARCHAR2(10)		not populated

AGGREGATEENERGY	NUMBER(16,6)		Aggregate energy sold, in MWh
SALES	NUMBER(16,6)		\$ income
PURCHASES	NUMBER(16,6)		\$ outgoing
LASTCHANGED	DATE		Last date and time record changed
PURCHASEDENERGY	NUMBER(16,6)		Amount of energy purchased in MWh
MDA	VARCHAR2(10)		Metering Data Agent supplying data

9.36 Table: BILLINGINTERRESIDUES

9.36.1 BILLINGINTERRESIDUES

Name BILLINGINTERRESIDUES
Comment BILLINGINTERRESIDUES shows interregion residues payable to NSP.

9.36.2 Description

Source

Obsolete, was weekly with billing run.

9.36.3 Notes

Name	Comment	Value
Visibility	Data in this table is:	Private

9.36.4 Primary Key Columns

Name
BILLRUNNO
CONTRACTYEAR
INTERCONNECTORID
PARTICIPANTID
REGIONID
WEEKNO

9.36.5 Index Columns

Name

LASTCHANGED

9.36.6 Content

Name	Data Type	Mandatory	Comment
ALLOCATION	NUMBER(6,3)		May not be necessary
TOTALSURPLUS	NUMBER(15,5)		May not be necessary
INTERCONNECTORID	VARCHAR2(10)	X	Unique identifier for an interconnector which joins two regions.
CONTRACTYEAR	NUMBER(4,0)	X	AEMO Contract Year number starting in week containing 1st January
WEEKNO	NUMBER(3,0)	X	Week no within the contract year. Week no 1 is the week containing 1st January
BILLRUNNO	NUMBER(3,0)	X	Unique run no within a given contract year and week no
PARTICIPANTID	VARCHAR2(10)	X	Unique participant identifier
SURPLUSVALUE	NUMBER(15,6)		Amount NSP is paid for Inter-Regional Residues
LASTCHANGED	DATE		Last date and time record changed
REGIONID	VARCHAR2(10)	X	Region ID

9.37 Table: BILLINGINTRARESIDUES

9.37.1 BILLINGINTRARESIDUES

Name	BILLINGINTRARESIDUES
Comment	BILLINGINTRARESIDUES shows intra-region settlement residue details for each Transmission Network Service Provider participant by region.

9.37.2 Description

BILLINGINTRARESIDUES is confidential to the relevant participant.

Source

BILLINGINTRARESIDUES is populated by the posting of a billing run, being several times each week.

Volume

An indicative maximum is two records inserted per billing run, or 22 records inserted per week.

9.37.3 Notes

Name	Comment	Value
Visibility	Data in this table is:	Private

9.37.4 Primary Key Columns

Name

BILLRUNNO

CONTRACTYEAR

PARTICIPANTID

REGIONID

WEEKNO

9.37.5 Index Columns

Name

LASTCHANGED

9.37.6 Content

Name	Data Type	Mandatory	Comment
ALLOCATION	NUMBER(6,3)		TNSP allocation
TOTALSURPLUS	NUMBER(15,5)		Total \$ residue amount for the region
CONTRACTYEAR	NUMBER(4,0)	X	AEMO Contract Year number starting in week containing 1st January
WEEKNO	NUMBER(3,0)	X	Week no within the contract year. Week no 1 is the week containing 1st January
BILLRUNNO	NUMBER(3,0)	X	Unique run no within a given contract year and week no
PARTICIPANTID	VARCHAR2(10)	X	Unique participant identifier
SURPLUSVALUE	NUMBER(15,6)		Amount TNSP is paid for Intra-Regional Residues
LASTCHANGED	DATE		Last changed date
REGIONID	VARCHAR2(10)	X	Region ID

9.38 Table: BILLINGIRAUCSURPLUS

9.38.1 BILLINGIRAUCSURPLUS

Name	BILLINGIRAUCSURPLUS
Comment	BILLINGIRAUCSURPLUS supports the Settlements Residue Auction, by showing the weekly billing Interconnector Residue (IR) payments as calculated for each bill run for Network Service Providers (NSPs) from the amount not auctioned.

9.38.2 Description

Source

Obsolete

Volume

This view contains a maximum of 30, 000 records per year.

9.38.3 Notes

Name	Comment	Value
Visibility	Data in this table is:	Private

9.38.4 Primary Key Columns

Name

BILLRUNNO

CONTRACTID

CONTRACTYEAR

FROMREGIONID

INTERCONNECTORID

PARTICIPANTID

WEEKNO

9.38.5 Index Columns

Name

LASTCHANGED

9.38.6 Content

Name	Data Type	Mandatory	Comment
CONTRACTYEAR	NUMBER(4,0)	X	SRA Contracted Year (calendar year)
WEEKNO	NUMBER(2,0)	X	Week no within the contract year. Week no 1 is the week containing 1st January
RESIDUEYEAR	NUMBER(4,0)		Year of the Residue Contract; may differ from the calendar year at week 1.
QUARTER	NUMBER(2,0)		Residue Contract Quarter
BILLRUNNO	NUMBER(3,0)	X	The sequential number of a billing run
CONTRACTID	VARCHAR2(30)	X	SRA Contract unique identifier
PARTICIPANTID	VARCHAR2(10)	X	Unique participant identifier
INTERCONNECTORID	VARCHAR2(10)	X	Contracted Interconnector
FROMREGIONID	VARCHAR2(10)	X	Nominated source region for Interconnector

TOTALRESIDUES	NUMBER(15,5)		Total residues allocated to participant
ADJUSTMENT	NUMBER(15,5)		Adjustment allocated to participant
LASTCHANGED	DATE		Date and time this record was last modified

9.39 Table: BILLINGIRAUCSURPLUSSUM

9.39.1 BILLINGIRAUCSURPLUSSUM

Name	BILLINGIRAUCSURPLUSSUM
Comment	BILLINGIRAUCSURPLUSSUM contains Auction fees and Settlements Residue Auction distribution that may arise from unpurchased auction units that accrue to Transmission Network Service Providers.

9.39.2 Description

BILLINGIRAUCSURPLUSSUM is confidential to the relevant participant.

Source

BILLINGIRAUCSURPLUSSUM is populated by the posting of a billing run where there are unpurchased auction units.

Volume

An indicative maximum is eight records inserted per billing run, or 88 records inserted per week.

9.39.3 Notes

Name	Comment	Value
Visibility	Data in this table is:	Private

9.39.4 Primary Key Columns

- Name
- BILLRUNNO
- CONTRACTYEAR
- FROMREGIONID
- INTERCONNECTORID
- PARTICIPANTID

QUARTER

RESIDUEYEAR

WEEKNO

9.39.5 Index Columns

Name

LASTCHANGED

9.39.6 Content

Name	Data Type	Mandatory	Comment
CONTRACTYEAR	NUMBER(4,0)	X	Contracted Year (calendar year)
WEEKNO	NUMBER(3,0)	X	Week no within the contract year. Week no 1 is the week containing 1st January
RESIDUEYEAR	NUMBER(4,0)	X	Year of the Residue Contract; may differ from the calendar year at week 1.
QUARTER	NUMBER(2,0)	X	Residue Contract Quarter
BILLRUNNO	NUMBER(3,0)	X	The sequential number of a billing run
INTERCONNECTORID	VARCHAR2(10)	X	Contracted Interconnector
FROMREGIONID	VARCHAR2(10)	X	Nominated source region for Interconnector
PARTICIPANTID	VARCHAR2(10)	X	Unique participant identifier

TOTALSURPLUS	NUMBER(15,5)		Total residue amount allocated to participant
AUCTIONFEES	NUMBER(15,5)		Total auction fees payable in this week (negative amount). If $AUCTIONFEES + AUCTIONFEES_GST \geq TOTALSURPLUS$ then ACTUALPAYMENT is zero
ACTUALPAYMENT	NUMBER(15,5)		Net payment to participant, including auction fees
AUCTIONFEES_GST	NUMBER(15,5)		The GST amount on the auction fees, always being zero.
LASTCHANGED	DATE		Date and time this record was last modified
CSP_DEROGATION_AMOUNT	NUMBER(18,8)		The CSP derogation amount applied as an adjustment to SRA.
UNADJUSTED_IRSR	NUMBER(18,8)		The SRA amount unadjusted by CSP.
NEGATIVE_RESIDUES	NUMBER(18,8)		Negative residues in the billing week for this participant in the SRA Year/Quarter

9.40 Table: BILLINGIRFM

9.40.1 BILLINGIRFM

Name	BILLINGIRFM
Comment	BILLINGIRFM shows billing amounts associated with Industrial Relations Forced Majeure events for each participant.

9.40.2 Description

BILLINGIRFM is confidential to the relevant participant.

Source

BILLINGIRFM is updated with each billing run as required.

9.40.3 Notes

Name	Comment	Value
Visibility	Data in this table is:	Private

9.40.4 Primary Key Columns

- Name
- BILLRUNNO
- CONTRACTYEAR
- PARTICIPANTID
- WEEKNO

9.40.5 Index Columns

- Name
- LASTCHANGED

9.40.6 Content

Name	Data Type	Mandatory	Comment
CONTRACTYEAR	NUMBER(4,0)	X	Settlement Year
WEEKNO	NUMBER(3,0)	X	Week number starting 1 Jan each year.
BILLRUNNO	NUMBER(3,0)	X	Unique bill run
PARTICIPANTID	VARCHAR2(10)	X	Participant Identifier
IRFMPAYMENT	NUMBER(15,5)		Industrial Relations Forced Majeure payment for the billing period.
LASTCHANGED	DATE		Last changed.

9.41 Table: BILLINGIRNSPSURPLUS

9.41.1 BILLINGIRNSPSURPLUS

Name	BILLINGIRNSPSURPLUS
Comment	BILLINGIRNSPSURPLUS supports the Settlements Residue Auction (SRA), by showing the weekly billing Interconnector Residue (IR) payments as calculated for each bill run for Transmission Network Service Providers (TNSP) from the amount paid by participants (i.e. derogated amounts).

9.41.2 Description

BILLINGIRNSPSURPLUS data is confidential to the relevant participant.

Source

BILLINGIRNSPSURPLUS updates in a billing run where any derogated Settlement Residue Auction purchase flows to a TNSP.

Volume

BILLINGIRNSPSURPLUS contains a maximum of 30, 000 records per year.

9.41.3 Notes

Name	Comment	Value
Visibility	Data in this table is:	Private

9.41.4 Primary Key Columns

- Name
- BILLRUNNO
- CONTRACTID
- CONTRACTYEAR
- FROMREGIONID

INTERCONNECTORID

PARTICIPANTID

WEEKNO

9.41.5 Index Columns

Name

LASTCHANGED

9.41.6 Content

Name	Data Type	Mandatory	Comment
CONTRACTYEAR	NUMBER(4,0)	X	AEMO Contract Year number starting in week containing 1st January
WEEKNO	NUMBER(2,0)	X	Week no within the contract year. Week no 1 is the week containing 1st January
RESIDUEYEAR	NUMBER(4,0)		Year of the Residue Contract; may differ from the calendar year at week 1.
QUARTER	NUMBER(2,0)		Residue Contract Quarter
BILLRUNNO	NUMBER(3,0)	X	The sequential number of a billing run
CONTRACTID	VARCHAR2(30)	X	SRA Contract unique identifier
PARTICIPANTID	VARCHAR2(10)	X	Unique participant identifier

INTERCONNECTORID	VARCHAR2(10))	X	Contracted Interconnector
FROMREGIONID	VARCHAR2(10))	X	Nominated source region for Interconnector
TOTALRESIDUES	NUMBER(15,5)		Total residues allocated to participant
ADJUSTMENT	NUMBER(15,5)		Adjustment allocated to participant
LASTCHANGED	DATE		Date and time this record was last modified

9.42 Table: BILLINGIRNSPURPLUSSUM

9.42.1 BILLINGIRNSPURPLUSSUM

Name	BILLINGIRNSPURPLUSSUM
Comment	BILLINGIRNSPURPLUSSUM contains derogated payments made to TNSPs arising from the Settlements Residue Auction process.

9.42.2 Description

BILLINGIRNSPURPLUSSUM data is confidential to the relevant participant.

Source

BILLINGIRNSPURPLUSSUM is populated by the posting of a billing run where derogated payments apply.

Volume

An indicative maximum is two records inserted per billing run, or 22 records inserted per week.

9.42.3 Notes

Name	Comment	Value
Visibility	Data in this table is:	Private

9.42.4 Primary Key Columns

- Name
- BILLRUNNO
- CONTRACTYEAR
- FROMREGIONID
- INTERCONNECTORID
- PARTICIPANTID
- QUARTER

RESIDUEYEAR

WEEKNO

9.42.5 Index Columns

Name

LASTCHANGED

9.42.6 Content

Name	Data Type	Mandatory	Comment
CONTRACTYEAR	NUMBER(4,0)	X	SRA Contracted Year (calendar year)
WEEKNO	NUMBER(3,0)	X	Week no within the contract year. Week no 1 is the week containing 1st January
RESIDUEYEAR	NUMBER(4,0)	X	Year of the Residue Contract; may differ from the calendar year at week 1.
QUARTER	NUMBER(2,0)	X	SRA Contracted Quarter
BILLRUNNO	NUMBER(3,0)	X	The sequential number of a billing run
INTERCONNECTORID	VARCHAR2(10)	X	Contracted Interconnector
FROMREGIONID	VARCHAR2(10)	X	Nominated source region for Interconnector
PARTICIPANTID	VARCHAR2(10)	X	Unique participant identifier

TOTALSURPLUS	NUMBER(15,5)		Total residue amount allocated to participant
AUCTIONFEES	NUMBER(15,5)		This field is 0.
AUCTIONFEES_GST	NUMBER(15,5)		The GST amount on the auction fees, always being zero.
LASTCHANGED	DATE		Date and time this record was last modified
CSP_DEROGATION_AMOUNT	NUMBER(18,8)		The CSP derogation amount applied as an adjustment to SRA.
UNADJUSTED_IRSR	NUMBER(18,8)		The SRA amount unadjusted by CSP.

9.43 Table: BILLINGIRPARTSURPLUS

9.43.1 BILLINGIRPARTSURPLUS

Name	BILLINGIRPARTSURPLUS
Comment	BILLINGIRPARTSURPLUS supports the Settlements Residue Auction, by showing the weekly billing SRA distribution to Auction participants by Contract Identifier.

9.43.2 Description

BILLINGIRPARTSURPLUS data is confidential to the relevant participant.

Source

BILLINGIRPARTSURPLUS is populated by the posting of a billing run where the participant has purchased auction units relating to that billing run.

Volume

An indicative maximum is 64 records inserted per billing run, or 700 records inserted per week.

9.43.3 Notes

Name	Comment	Value
Visibility	Data in this table is:	Private

9.43.4 Primary Key Columns

Name

BILLRUNNO

CONTRACTID

CONTRACTYEAR

FROMREGIONID

INTERCONNECTORID

PARTICIPANTID

WEEKNO

9.43.5 Index Columns

Name

LASTCHANGED

9.43.6 Content

Name	Data Type	Mandatory	Comment
CONTRACTYEAR	NUMBER(4,0)	X	SRA Contracted Year (calendar year)
WEEKNO	NUMBER(2,0)	X	Week no within the contract year. Week no 1 is the week containing 1st January
RESIDUEYEAR	NUMBER(4,0)		Year of the Residue Contract; may differ from the calendar year at week 1.
QUARTER	NUMBER(2,0)		Residue Contract Quarter
BILLRUNNO	NUMBER(3,0)	X	The sequential number of a billing run
CONTRACTID	VARCHAR2(30)	X	SRA Contract unique identifier
PARTICIPANTID	VARCHAR2(10)	X	Unique participant identifier
INTERCONNECTORID	VARCHAR2(10)	X	Contracted Interconnector

FROMREGIONID	VARCHAR2(10)	X	Nominated source region for Interconnector
TOTALRESIDUES	NUMBER(15,5)		Total residues allocated to participant
ADJUSTMENT	NUMBER(15,5)		Adjustment allocated to participant
LASTCHANGED	DATE		Date and time this record was last modified
ACTUALPAYMENT	NUMBER(15,5)		Net actual payment to participant, including auction fees

9.44 Table: BILLINGIRPARTSURPLUSSUM

9.44.1 BILLINGIRPARTSURPLUSSUM

Name	BILLINGIRPARTSURPLUSSUM
Comment	BILLINGIRPARTSURPLUSSUM supports the Settlements Residue Auction, by showing the weekly billing SRA distribution and associated fees to Auction participants.

9.44.2 Description

BILLINGIRPARTSURPLUSSUM data is confidential to the relevant participant.

Source

BILLINGIRPARTSURPLUSSUM is populated by the posting of a billing run where the participant has purchased auction units relating to that billing run.

Volume

An indicative maximum is 16 records inserted per billing run, or 166 records inserted per week.

9.44.3 Notes

Name	Comment	Value
Visibility	Data in this table is:	Private

9.44.4 Primary Key Columns

- Name
- BILLRUNNO
- CONTRACTYEAR
- FROMREGIONID
- INTERCONNECTORID
- PARTICIPANTID

QUARTER

RESIDUEYEAR

WEEKNO

9.44.5 Index Columns

Name

RESIDUEYEAR

QUARTER

9.44.6 Index Columns

Name

LASTCHANGED

9.44.7 Content

Name	Data Type	Mandatory	Comment
CONTRACTYEAR	NUMBER(4,0)	X	SRA Contracted Year (calendar year)
WEEKNO	NUMBER(3,0)	X	Week no within the contract year. Week no 1 is the week containing 1st January
RESIDUEYEAR	NUMBER(4,0)	X	Year of the Residue Contract; may differ from the calendar year at week 1.
QUARTER	NUMBER(2,0)	X	Residue Contract Quarter
BILLRUNNO	NUMBER(3,0)	X	The sequential number of a billing

			run
INTERCONNECTORID	VARCHAR2(10))	X	Contracted Interconnector
FROMREGIONID	VARCHAR2(10))	X	Nominated source region for Interconnector
PARTICIPANTID	VARCHAR2(10))	X	Unique participant identifier
TOTALSURPLUS	NUMBER(15,5)		Total residue amount allocated to participant
AUCTIONFEES	NUMBER(15,5)		Total auction fees payable in this week (negative amount). If AUCTIONFEES + AUCTIONFEES_GST >= TOTALSURPLUS then ACTUALPAYMENT is zero.
ACTUALPAYMENT	NUMBER(15,5)		Net payment to participant, including auction fees
AUCTIONFEES_GST	NUMBER(15,5)		The GST amount on the auction fees, always being zero.
LASTCHANGED	DATE		Date and time this record was last modified
CSP_DEROGATION_AMOUNT	NUMBER(18,8)		The CSP derogation amount applied as an adjustment to SRA.
UNADJUSTED_IRSR	NUMBER(18,8)		The SRA amount unadjusted by CSP.
AUCTIONFEES_TOTALGROSS_ADJ	Number(18,8)		The adjusted total Auction fees for the Directional Interconnector. Calculated as the amount of the total fees due from the SRA Auction Participant, pro-rated based on the total surplus for each

			Directional Interconnector the SRA Auction Participant contracted.
--	--	--	--

9.45 Table: BILLINGPRIORADJUSTMENTS

9.45.1 BILLINGPRIORADJUSTMENTS

Name	BILLINGPRIORADJUSTMENTS
Comment	BILLINGPRIORADJUSTMENTS sets out prior period adjustments and associated interest inserted in subsequent Final Statements arising from Revision Statement postings.

9.45.2 Description

BILLINGPRIORADJUSTMENTS data is confidential to the relevant participant.

Source

BILLINGPRIORADJUSTMENTS is populated on the posting of a Final billing run only.

Volume

Approximately two records inserted per week.

Note

Actual adjustment payable is $ADJAMOUNT - PERAMOUNT + INTEREST\ AMOUNT$.

9.45.3 Notes

Name	Comment	Value
Visibility	Data in this table is:	Private

9.45.4 Primary Key Columns

- Name
- ADJBILLRUNNO
- ADJCONTRACTYEAR
- ADJWEEKNO
- BILLRUNNO
- CONTRACTYEAR

PARTICIPANTID

WEEKNO

9.45.5 Index Columns

Name

LASTCHANGED

9.45.6 Index Columns

Name

PARTICIPANTID

LASTCHANGED

9.45.7 Content

Name	Data Type	Mandatory	Comment
CONTRACTYEAR	NUMBER(4,0)	X	Settlement year.
WEEKNO	NUMBER(3,0)	X	Settlement week number.
BILLRUNNO	NUMBER(3,0)	X	Billing run number.
ADJCONTRACTYEAR	NUMBER(4,0)	X	ContractYear of the posted revision statement inserted to the Final Statement
ADJWEEKNO	NUMBER(3,0)	X	WeekNo of the posted revision statement inserted to the Final Statement
ADJBILLRUNNO	NUMBER(3,0)	X	Bill run number of the posted revision statement inserted to the

			Final Statement
PARTICIPANTID	VARCHAR2(10)	X	Participant ID
PREVAMOUNT	NUMBER(15,5)		Statement total of the previous posted revision statement inserted to the Final Statement.
ADJAMOUNT	NUMBER(15,5)		Adjusted amount.
IRN	NUMBER(15,5)		Interest rate applied to the revision adjustment
IRP	NUMBER(15,5)		unused; always null
INTERESTAMOUNT	NUMBER(15,5)		Interest amount.
LASTCHANGED	DATE		Last changed.
IRSR_PREVAMOUNT	NUMBER(15,5)		unused; always null
IRSR_ADJAMOUNT	NUMBER(15,5)		unused; always null
IRSR_INTERESTAMOUNT	NUMBER(15,5)		unused; always null

9.46 Table: BILLINGREALLOC

9.46.1 BILLINGREALLOC

Name	BILLINGREALLOC
Comment	BILLINGREALLOC shows reallocation contract values in each billing run, where participants have used reallocations.

9.46.2 Description

BILLINGREALLOC data is confidential to the relevant participant.

Source

BILLINGREALLOC is populated by the posting of a billing run.

Volume

An indicative maximum is two records inserted per billing run, or 22 records inserted per week.

9.46.3 Notes

Name	Comment	Value
Visibility	Data in this table is:	Private

9.46.4 Primary Key Columns

Name
 BILLRUNNO
 CONTRACTYEAR
 COUNTERPARTY
 PARTICIPANTID
 WEEKNO

9.46.5 Index Columns

Name

LASTCHANGED

9.46.6 Index Columns

Name

PARTICIPANTID

9.46.7 Content

Name	Data Type	Mandatory	Comment
CONTRACTYEAR	NUMBER(4,0)	X	AEMO Contract Year number starting in week containing 1st January
WEEKNO	NUMBER(3,0)	X	Week no within the contract year. Week no 1 is the week containing 1st January
BILLRUNNO	NUMBER(3,0)	X	Unique run no within a given contract year and week no
PARTICIPANTID	VARCHAR2(10)	X	Unique participant identifier
COUNTERPARTY	VARCHAR2(10)	X	Participant who is the counter party to this contract
VALUE	NUMBER(15,5)		Value billed on this contract
LASTCHANGED	DATE		Last date and time record changed

9.47 Table: BILLINGREALLOC_DETAIL

9.47.1 BILLINGREALLOC_DETAIL

Name	BILLINGREALLOC_DETAIL
Comment	Billing Reallocation Data aggregated by REALLOCATIONID for each billing run over the billing week.

9.47.2 Description

The BILLINGREALLOC_DETAIL table that will give a breakdown of the reallocations that form part of that billing run. This assists participants in their settlement reconciliation process.

Private data

Volume max 100 rows per day

9.47.3 Notes

Name	Comment	Value
Visibility	Data in this table is:	Private

9.47.4 Primary Key Columns

Name

BILLRUNNO

CONTRACTYEAR

COUNTERPARTY

PARTICIPANTID

REALLOCATIONID

WEEKNO

9.47.5 Index Columns

Name

LASTCHANGED

9.47.6 Content

Name	Data Type	Mandatory	Comment
CONTRACTYEAR	NUMBER(4,0)	X	BILLING CONTRACTYEAR
WEEKNO	NUMBER(3,0)	X	BILLING WEEKNO
BILLRUNNO	NUMBER(3,0)	X	BILLING RUN NO
PARTICIPANTID	VARCHAR2(10)	X	REALLOCATION PARTICIPANTID
COUNTERPARTY	VARCHAR2(10)	X	REALLOCATION COUNTERPARTY PARTICIPANTID
REALLOCATIONID	VARCHAR2(20)	X	REALLOCATIONID
VALUE	NUMBER(15,5)		REALLOCATION VALUE
LASTCHANGED	DATE		DATETIME WHEN RECORD SAVED

9.48 Table: BILLINGREGIONEXPORTS

9.48.1 BILLINGREGIONEXPORTS

Name	BILLINGREGIONEXPORTS
Comment	BILLINGREGIONEXPORTS sets out the region summary table of overall energy exported to and from each region for each billing run.

9.48.2 Description

BILLINGREGIONEXPORTS data is public, and is available to all participants.

Source

BILLINGREGIONEXPORTS is populated by the posting of a billing run.

Volume

Eight records inserted per billing run, or 88 records inserted per week.

9.48.3 Notes

Name	Comment	Value
Visibility	Data in this table is:	Public

9.48.4 Primary Key Columns

- Name
- BILLRUNNO
- CONTRACTYEAR
- EXPORTTO
- REGIONID
- WEEKNO

9.48.5 Index Columns

Name

LASTCHANGED

9.48.6 Content

Name	Data Type	Mandatory	Comment
CONTRACTYEAR	NUMBER(4,0)	X	AEMO Contract Year number starting in week containing 1st January
WEEKNO	NUMBER(3,0)	X	Week no within the contract year. Week no 1 is the week containing 1st January
BILLRUNNO	NUMBER(3,0)	X	Unique run no within a given contract year and week no
REGIONID	VARCHAR2(10)	X	Unique region identifier
EXPORTTO	VARCHAR2(10)	X	Region exported to
ENERGY	NUMBER(16,6)		MWh Energy value exported
VALUE	NUMBER(15,5)		\$ Value of energy exported
SURPLUSENERGY	NUMBER(16,6)		This field is populated with 0
SURPLUSVALUE	NUMBER(15,5)		\$ Interregional residue
LASTCHANGED	DATE		Last date and time record changed

9.49 Table: BILLINGREGIONFIGURES

9.49.1 BILLINGREGIONFIGURES

Name	BILLINGREGIONFIGURES
Comment	BILLINGREGIONFIGURES sets out additional summary region details including ancillary service amounts for each billing run.

9.49.2 Description

BILLINGREGIONFIGURES is public data, and is available to all participants.

Source

BILLINGREGIONFIGURES is populated by the posting of a billing run.

Volume

Five records inserted per billing run, or 55 records inserted per week.

9.49.3 Notes

Name	Comment	Value
Visibility	Data in this table is:	Public

9.49.4 Primary Key Columns

- Name
- BILLRUNNO
- CONTRACTYEAR
- REGIONID
- WEEKNO

9.49.5 Index Columns

- Name

LASTCHANGED

9.49.6 Content

Name	Data Type	Mandatory	Comment
CONTRACTYEAR	NUMBER(4,0)	X	AEMO Contract Year number starting in week containing 1st January
WEEKNO	NUMBER(3,0)	X	Week no within the contract year. Week no 1 is the week containing 1st January
BILLRUNNO	NUMBER(3,0)	X	Unique run no within a given contract year and week no
REGIONID	VARCHAR2(10)	X	Unique region identifier
ENERGYOUT	NUMBER(16,6)		MWh Energy output in the region during the billing period
VALUEOUT	NUMBER(16,6)		\$ Value of energy output in region during billing period
ENERGYPURCHASED	NUMBER(16,6)		MWh Amount of energy purchased in region during billing period
VALUEPURCHASED	NUMBER(16,6)		\$ Value of energy purchased during billing period
EXCESSGEN	NUMBER(16,6)		This field is populated with 0
RESERVETRAIDING	NUMBER(16,6)		This field is populated with 0
INTCOMPO	NUMBER(16,6)		This field is populated with 0
ADMINPRICECOMPO	NUMBER(16,6)		This field is populated with 0

SETTSURPLUS	NUMBER(16,6)		Intraregional residues in \$
ASPAYMENT	NUMBER(16,6)		Ancillary service payments in \$
POOLFEES	NUMBER(16,6)		This field is populated with 0
LASTCHANGED	DATE		Last date and time record changed

9.50 Table: BILLINGREGIONIMPORTS

9.50.1 BILLINGREGIONIMPORTS

Name	BILLINGREGIONIMPORTS
Comment	BILLINGREGIONIMPORTS sets out the region summary table of overall energy imported to and from each region for each billing run.

9.50.2 Description

BILLINGREGIONIMPORTS is public data, and is available to all participants.

Source

BILLINGREGIONIMPORTS is populated by the posting of a billing run.

Volume

Eight records inserted per billing run, or 88 records inserted per week.

9.50.3 Notes

Name	Comment	Value
Visibility	Data in this table is:	Public

9.50.4 Primary Key Columns

- Name
- BILLRUNNO
- CONTRACTYEAR
- IMPORTFROM
- REGIONID
- WEEKNO

9.50.5 Index Columns

Name

LASTCHANGED

9.50.6 Content

Name	Data Type	Mandatory	Comment
CONTRACTYEAR	NUMBER(4,0)	X	AEMO Contract Year number starting in week containing 1st January
WEEKNO	NUMBER(3,0)	X	Week no within the contract year. Week no 1 is the week containing 1st January
BILLRUNNO	NUMBER(3,0)	X	Unique run no within a given contract year and week no
REGIONID	VARCHAR2(10)	X	Unique region identifier
IMPORTFROM	VARCHAR2(10)	X	Region energy imported from
ENERGY	NUMBER(16,6)		Amount of energy imported
VALUE	NUMBER(15,5)		Value of energy imported
SURPLUSENERGY	NUMBER(16,6)		Populated with 0
SURPLUSVALUE	NUMBER(15,5)		Interregional residue
LASTCHANGED	DATE		Last date and time record changed

9.51 Table: BILLINGRUNTRK

9.51.1 BILLINGRUNTRK

Name	BILLINGRUNTRK
Comment	BILLINGRUNTRK identifies the Statement type (i.e. Status of PRELIM, FINAL, REVISE) and date of the BillRunNo posted, per WeekNo. This provides a further extension of tracking data from the BILLINGDAYTRK table.

9.51.2 Description

BILLINGRUNTRK is public data, and is available to all participants.

Source

BILLINGRUNTRK is populated by the posting of a billing run.

Volume

An indicative maximum is one record inserted per billing run, or 11 records inserted per week.

9.51.3 Notes

Name	Comment	Value
Visibility	Data in this table is:	Public

9.51.4 Primary Key Columns

Name
 BILLRUNNO
 CONTRACTYEAR
 WEEKNO

9.51.5 Index Columns

Name

LASTCHANGED

9.51.6 Content

Name	Data Type	Mandatory	Comment
CONTRACTYEAR	NUMBER(4,0)	X	Year of the run
WEEKNO	NUMBER(3,0)	X	Week number of the run
BILLRUNNO	NUMBER(3,0)	X	Sequential run number
STATUS	VARCHAR2(6)		The billing run type, PRELIM, FINAL, REVISE or INTERIM
ADJ_CLEARED	VARCHAR2(1)		Flag
AUTHORISEDDATE	DATE		null, since not used
AUTHORISEDBY	VARCHAR2(10)		null, since not used
POSTDATE	DATE		When the results were posted
POSTBY	VARCHAR2(10)		Who posted the results
LASTCHANGED	DATE		Last date and time record changed
RECEIPTPOSTDATE	DATE		null, since not used
RECEIPTPOSTBY	VARCHAR2(10)		null, since not used
PAYMENTPOSTDATE	DATE		When the payment was posted
PAYMENTPOSTBY	VARCHAR2(10)		Who posted the payment
SHORTFALL	NUMBER(16,6)		Payment shortfall amount

MAKEUP	NUMBER(15,5)		Not Used
--------	--------------	--	----------

9.52 Table: BILLINGSMELTERREDUCTION

9.52.1 BILLINGSMELTERREDUCTION

Name	BILLINGSMELTERREDUCTION
Comment	BILLINGSMELTERREDUCTION shows the smelter reduction payment (only applies to participants with Victorian customer connection points).

9.52.2 Description

BILLINGSMELTERREDUCTION data is confidential to the relevant participant.

Source

BILLINGSMELTERREDUCTION is populated by the posting of a billing run where the participant has Victorian customer connectionpoints.

Volume

One record inserted per billing run, or 11 records inserted per week.

9.52.3 Notes

Name	Comment	Value
Visibility	Data in this table is:	Private

9.52.4 Primary Key Columns

- Name
- BILLRUNNO
- CONTRACTYEAR
- PARTICIPANTID
- WEEKNO

9.52.5 Index Columns

Name

PARTICIPANTID

9.52.6 Index Columns

Name

LASTCHANGED

9.52.7 Content

Name	Data Type	Mandatory	Comment
CONTRACTYEAR	NUMBER(22,0)	X	AEMO Contract Year number starting in week containing 1st January
WEEKNO	NUMBER(22,0)	X	Week no within the contract year. Week no 1 is the week containing 1st January
BILLRUNNO	NUMBER(22,0)	X	Unique run no within a given contract year and week no
PARTICIPANTID	VARCHAR2(10)	X	Unique participant identifier
RATE1	NUMBER(15,6)		Rate in \$/MWh
RA1	NUMBER(15,6)		Payment
RATE2	NUMBER(15,6)		Rate in \$/MWh
RA2	NUMBER(15,6)		Payment
TE	NUMBER(15,6)		Tabulated Energy

PCSD	NUMBER(15,6)		Victorian Demand as defined by Code Chapter 9 definitions
LASTCHANGED	DATE		Last date and time record changed

9.53 Table: BILLWHITEHOLE

9.53.1 BILLWHITEHOLE

Name	BILLWHITEHOLE
Comment	BILLWHITEHOLE shows white hole payments based on participant vs region demand.

9.53.2 Description

Confidential

Source

Obsolete; was updated weekly with each billing run.

9.53.3 Notes

Name	Comment	Value
Visibility	Data in this table is:	Private

9.53.4 Primary Key Columns

Name

BILLRUNNO

CONTRACTYEAR

INTERCONNECTORID

PARTICIPANTID

WEEKNO

9.53.5 Index Columns

Name

LASTCHANGED

9.53.6 Content

Name	Data Type	Mandatory	Comment
CONTRACTYEAR	NUMBER(22,0)	X	AEMO Contract Year number starting in week containing 1st January
WEEKNO	NUMBER(22,0)	X	Week no within the contract year. Week no 1 is the week containing 1st January
BILLRUNNO	NUMBER(22,0)	X	Unique run no within a given contract year and week no
PARTICIPANTID	VARCHAR2(10)	X	Unique participant identifier
NL	NUMBER(15,6)		Sum of billing week (RRP * interconnector flow)
PARTICIPANTDEMAND	NUMBER(15,6)		The sum of all customer purchases in MWh
REGIONDEMAND	NUMBER(15,6)		Sum of all region purchases in MWh
WHITEHOLEPAYMENT	NUMBER(15,6)		Payment in \$
LASTCHANGED	DATE		The latest date and time that a file was updated or inserted
INTERCONNECTORID	VARCHAR2(10)	X	Interconnector ID

10 Package: DEMAND_FORECASTS

<i>Name</i>	DEMAND_FORECASTS
<i>Comment</i>	Regional Demand Forecasts and Intermittent Generation forecasts.

10.1 List of tables

Name	Comment
DEMANDOPERATIONALACTUAL	Shows Actual Operational Demand for a particular date time interval.
DEMANDOPERATIONALFORECAST	Shows Forecast Operational Demand for a particular date time interval.
INTERMITTENT_CLUSTER_AVAIL	A submission of Elements Unavailable for an intermittent generating unit cluster, by Trading Day and Trading Interval
INTERMITTENT_CLUSTER_AVAIL_DAY	Summary record for an Elements Unavailable submission for an intermittent generating unit cluster for a Trading Day
INTERMITTENT_DS_PRED	Unconstrained Intermittent Generation Forecasts (UIGF) for Dispatch
INTERMITTENT_DS_RUN	Unconstrained Intermittent Generation Forecasts (UIGF) for Dispatch.
INTERMITTENT_GEN_FCST	Identifying record for a given forecast of an intermittent generation. This table is the version table for the INTERMITTENT_GEN_FCST_DATA table which stores the individual forecast values
INTERMITTENT_GEN_FCST_DATA	Stores the forecast generation (MW) for each interval within a given forecast of an intermittent generator.
INTERMITTENT_GEN_LIMIT	A submission of Upper MW Limit for an intermittent

	generating unit, by Trading Day and Trading Interval
INTERMITTENT_GEN_LIMIT_DAY	Summary record for an Upper MW Limit submission for an intermittent generating unit for a Trading Day
INTERMITTENT_P5_PRED	Unconstrained Intermittent Generation Forecasts (UIGF) for 5-Minute Pre-dispatch
INTERMITTENT_P5_RUN	Unconstrained Intermittent Generation Forecasts (UIGF) for 5-Minute Pre-dispatch
MTPASA_INTERMITTENT_AVAIL	A submission of expected plant availability for intermittent generators for use in MTPASA intermittent generation forecasts
MTPASA_INTERMITTENT_LIMIT	A submission of expected maximum availability for intermittent generators for use in MTPASA intermittent generation forecasts
PERDEMAND	PERDEMAND sets out the regional demands and MR schedule data for each half-hour period. PERDEMAND is a child table to RESDEMANDTRK.
RESDEMANDTRK	<p>RESDEMANDTRK defines the existence and versioning information of a forecast for a specific region and trading date.</p> <p>RESDEMANDTRK and PERDEMAND have a parent/child relationship, and are for defined forecast regional demands since market start. RESDEMANDTRK defines the existence and versioning information of a forecast for a specific region and trading date. PERDEMAND defines the numerical forecast values for each trading interval of a the trading day for that region. A complete trading day forecast for one region consists of one RESDEMANDTRK record and 48 PERDEMAND records.</p>
ROOFTOP_PV_ACTUAL	Estimate of regional Rooftop Solar actual generation for each half-hour interval in a day

ROOFTOP_PV_FORECAST	Regional forecasts of Rooftop Solar generation across the half-hour intervals over 8 days
---------------------	---

10.2 Diagram: Entities: Demand Forecasts

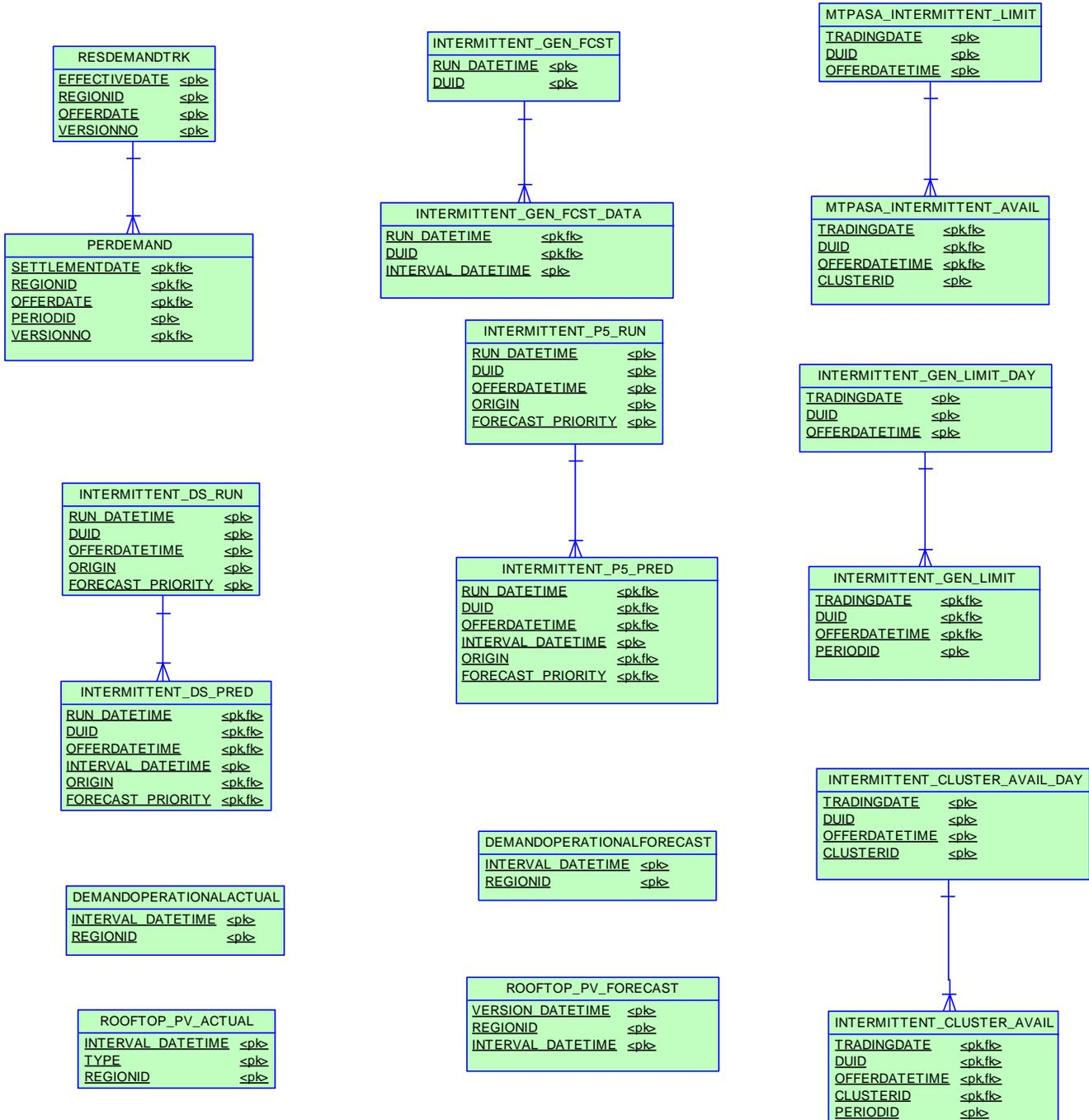

10.3 Table: DEMANDOPERATIONALACTUAL

10.3.1 DEMANDOPERATIONALACTUAL

Name DEMANDOPERATIONALACTUAL

Comment Shows Actual Operational Demand for a particular date time interval.

10.3.2 Notes

Name	Comment	Value
Visibility	Data in this table is:	Public

10.3.3 Primary Key Columns

Name

INTERVAL_DATETIME

REGIONID

10.3.4 Index Columns

Name

INTERVAL_DATETIME

REGIONID

10.3.5 Content

Name	Data Type	Mandatory	Comment
INTERVAL_DATETIME	date	X	Date time interval for operational demand value

REGIONID	Varchar2(20)	X	Region identifier
OPERATIONAL_DEMAND	number(10,0)		Operational demand value
LASTCHANGED	date		Last date and time record changed

10.4 Table: DEMANDOPERATIONALFORECAST

10.4.1 DEMANDOPERATIONALFORECAST

Name DEMANDOPERATIONALFORECAST

Comment Shows Forecast Operational Demand for a particular date time interval.

10.4.2 Notes

Name	Comment	Value
Visibility	Data in this table is:	Public

10.4.3 Primary Key Columns

Name

INTERVAL_DATETIME

REGIONID

10.4.4 Index Columns

Name

INTERVAL_DATETIME

REGIONID

10.4.5 Content

Name	Data Type	Mandatory	Comment
INTERVAL_DATETIME	date	X	Forecast for a particular date time interval

REGIONID	Varchar2(20)	X	Region identifier
LOAD_DATE	date		Date time this forecast was produced
OPERATIONAL_DEMAND_POE10	number(15,2)		10% probability of exceedance operational demand forecast value
OPERATIONAL_DEMAND_POE50	number(15,2)		50% probability of exceedance operational demand forecast value
OPERATIONAL_DEMAND_POE90	number(15,2)		90% probability of exceedance operational demand forecast value
LASTCHANGED	date		Last date and time record changed

10.5 Table: INTERMITTENT_CLUSTER_AVAIL

10.5.1 INTERMITTENT_CLUSTER_AVAIL

Name	INTERMITTENT_CLUSTER_AVAIL
Comment	A submission of Elements Unavailable for an intermittent generating unit cluster, by Trading Day and Trading Interval

10.5.2 Primary Key Columns

Name

CLUSTERID

DUID

OFFERDATETIME

PERIODID

TRADINGDATE

10.5.3 Content

Name	Data Type	Mandatory	Comment
TRADINGDATE	DATE	X	The trading day to which the availability submission applies
DUID	VARCHAR2(20)	X	Unique Identifier of Dispatchable Unit
OFFERDATETIME	DATE	X	Date and Time when this cluster availability submission was loaded
CLUSTERID	VARCHAR2(20)	X	Unique Cluster Identifier for this cluster within the DUID
PERIODID	NUMBER(3,0)	X	Trading interval number (1...48)

			within this TRADINGDATE for which ELEMENTS_UNAVAILABLE applies
ELEMENTS_UNAVAILABLE	NUMBER(3,0)		Number of elements within this CLUSTERID (turbines for wind, or inverters for solar) that are not available for this TRADINGDATE and PERIODID (scheduled maintenance in ANEMOS). Value between 0 and the registered Number of Cluster Elements. Value = 0 means no elements unavailable

10.6 Table: INTERMITTENT_CLUSTER_AVAIL_DAY

10.6.1 INTERMITTENT_CLUSTER_AVAIL_DAY

Name	INTERMITTENT_CLUSTER_AVAIL_DAY
Comment	Summary record for an Elements Unavailable submission for an intermittent generating unit cluster for a Trading Day

10.6.2 Primary Key Columns

Name
CLUSTERID
DUID
OFFERDATETIME
TRADINGDATE

10.6.3 Content

Name	Data Type	Mandatory	Comment
TRADINGDATE	DATE	X	Trading Day for which this cluster availability submission applies
DUID	VARCHAR2(20)	X	Unique Identifier of Dispatchable Unit
OFFERDATETIME	DATE	X	Date and Time when this cluster availability submission was loaded
CLUSTERID	VARCHAR2(20)	X	Unique Cluster Identifier for this cluster within the DUID

10.7 Table: INTERMITTENT_DS_PRED

10.7.1 INTERMITTENT_DS_PRED

Name INTERMITTENT_DS_PRED
 Comment Unconstrained Intermittent Generation Forecasts (UIGF) for Dispatch

10.7.2 Notes

Name Comment Value
 Visibility Data in this table is: Private; Public Next-Day

10.7.3 Primary Key Columns

Name
 DUID
 FORECAST_PRIORITY
 INTERVAL_DATETIME
 OFFERDATETIME
 ORIGIN
 RUN_DATETIME

10.7.4 Content

Name	Data Type	Mandatory	Comment
RUN_DATETIME	DATE	X	Date and Time when the forecast applies (dispatch interval ending)

DUID	VARCHAR2(20)	X	DUID (or Area for non-scheduled) where this forecast applies
OFFERDATETIME	DATE	X	Date and Time when this forecast submission was loaded
INTERVAL_DATETIME	DATE	X	Date and Time when the forecast applies (dispatch interval ending)
ORIGIN	VARCHAR2(20)	X	Origin of this forecast (PARTICIPANTID, AWEFS/ASEFS, or another vendor)
FORECAST_PRIORITY	NUMBER(10,0)	X	Unsuppressed forecasts with higher priority values are used in Dispatch in preference to unsuppressed forecasts with lower priority values
FORECAST_MEAN	NUMBER(18,8)		Forecast MW value for this interval_DateTime
FORECAST_POE10	NUMBER(18,8)		Forecast 10% POE MW value for this interval_DateTime
FORECAST_POE50	NUMBER(18,8)		Forecast 50% POE MW value for this interval_DateTime. Used in Dispatch.
FORECAST_POE90	NUMBER(18,8)		Forecast 90% POE MW value for this interval_DateTime

10.8 Table: INTERMITTENT_DS_RUN

10.8.1 INTERMITTENT_DS_RUN

Name	INTERMITTENT_DS_RUN
Comment	Unconstrained Intermittent Generation Forecasts (UIGF) for Dispatch.

10.8.2 Notes

Name	Comment	Value
Visibility	Data in this table is:	Private; Public Next-Day

10.8.3 Primary Key Columns

Name
 DUID
 FORECAST_PRIORITY
 OFFERDATETIME
 ORIGIN
 RUN_DATETIME

10.8.4 Content

Name	Data Type	Mandatory	Comment
RUN_DATETIME	DATE	X	Date and Time where the forecast applies (dispatch interval ending)
DUID	Varchar2(20)	X	DUID (or Area for non-scheduled) where this forecast applies

OFFERDATETIME	DATE	X	Date and Time when this forecast submission was loaded.
ORIGIN	Varchar2(20)	X	Origin of this forecast (PARTICIPANTID, AWEFS/ASEFS, or another vendor)
FORECAST_PRIORITY	NUMBER(10,0)	X	Unsuppressed forecasts with higher priority values are used in Dispatch in preference to unsuppressed forecasts with lower priority values.
AUTHORISED_BY	Varchar2(20)		Authorising officer of this forecast (applicable for participant forecasts only). This column is not made available to the public.
COMMENTS	Varchar2(200)		Comments relating to the forecast. This column is not made available to the public.
LASTCHANGED	DATE		Last date and time the record changed.
MODEL	Varchar2(30)		Metadata relating to the forecast. This column is not made available to the public.
PARTICIPANT_TIMESTAMP	DATE		Participant can document when the forecast was created
SUPPRESSED_AEMO	NUMBER(1,0)		Was this forecast suppressed by AEMO? Suppressed = 1, Not suppressed = 0
SUPPRESSED_PARTICIPANT	NUMBER(1,0)		Was this forecast suppressed by the participant? Suppressed submissions may not be used, Suppressed = 1, Not suppressed

			=0
TRANSACTION_ID	Varchar2(100)		Uniquely identifies this interaction

10.9 Table: INTERMITTENT_GEN_FCST

10.9.1 INTERMITTENT_GEN_FCST

Name	INTERMITTENT_GEN_FCST
Comment	Identifying record for a given forecast of an intermittent generation. This table is the version table for the INTERMITTENT_GEN_FCST_DATA table which stores the individual forecast values

10.9.2 Description

Source

INTERMITTENT_GEN_FCST updates every 30 minutes when AEMO issues a new 30-minute forecast of wind generation out to 40 hours ahead.

Volume

~18,000 rows per generator per year

10.9.3 Notes

Name	Comment	Value
Visibility	Data in this table is:	Private

10.9.4 Primary Key Columns

Name
 DUID
 RUN_DATETIME

10.9.5 Content

Name	Data Type	Mandatory	Comment

RUN_DATETIME	DATE	X	Date Time of forecast (AEST).
DUID	VARCHAR2(20)	X	Identifier of the intermittent generator.
START_INTERVAL_DATETIME	DATE	X	Date Time (AEST) of the first half-hour interval being forecast.
END_INTERVAL_DATETIME	DATE	X	Date Time (AEST) of the final half-hour interval being forecast.
VERSIONNO	NUMBER(10,0)		Versioning information for resolution back to AEMO's wind generation forecasting system.
LASTCHANGED	DATE		Date Time record was created

10.10 Table: INTERMITTENT_GEN_FCST_DATA

10.10.1 INTERMITTENT_GEN_FCST_DATA

Name	INTERMITTENT_GEN_FCST_DATA
Comment	Stores the forecast generation (MW) for each interval within a given forecast of an intermittent generator.

10.10.2 Description

Source

INTERMITTENT_GEN_FCST_DATA updates every 30 minutes when AEMO issues a new 30-minute forecast of wind generation out to 40 hours ahead.

Volume

~1,500,000 rows per generator per year

10.10.3 Notes

Name	Comment	Value
Visibility	Data in this table is:	Private

10.10.4 Primary Key Columns

- Name
- DUID
- INTERVAL_DATETIME
- RUN_DATETIME

10.10.5 Content

Name	Data Type	Mandatory	Comment
RUN_DATETIME	DATE	X	

DUID	VARCHAR2(20)	X	
INTERVAL_DATETIME	DATE	X	
POWERMEAN	NUMBER(9,3)		
POWERPOE50	NUMBER(9,3)		
POWERPOELOW	NUMBER(9,3)		
POWERPOEHIGH	NUMBER(9,3)		
LASTCHANGED	DATE		

10.11 Table: INTERMITTENT_GEN_LIMIT

10.11.1 INTERMITTENT_GEN_LIMIT

Name	INTERMITTENT_GEN_LIMIT
Comment	A submission of Upper MW Limit for an intermittent generating unit, by Trading Day and Trading Interval

10.11.2 Primary Key Columns

Name
DUID
OFFERDATETIME
PERIODID
TRADINGDATE

10.11.3 Content

Name	Data Type	Mandatory	Comment
TRADINGDATE	DATE	X	Trading Day for which this unit availability submission applies
DUID	VARCHAR2(20)	X	Unique Identifier of Dispatchable Unit
OFFERDATETIME	DATE	X	Date and Time when this unit availability submission was loaded
PERIODID	NUMBER(3,0)	X	Trading interval number (1...48) within this TRADINGDATE for which UPPERMWLIMIT applies
UPPERMWLIMIT	NUMBER(6)		Maximum imposed MW limit (down regulation in ANEMOS).

			Value between 0 and the registered DUID Maximum Capacity. Value = -1 means no limit applies
--	--	--	---

10.12 Table: INTERMITTENT_GEN_LIMIT_DAY

10.12.1 INTERMITTENT_GEN_LIMIT_DAY

Name	INTERMITTENT_GEN_LIMIT_DAY
Comment	Summary record for an Upper MW Limit submission for an intermittent generating unit for a Trading Day

10.12.2 Primary Key Columns

Name
DUID
OFFERDATETIME
TRADINGDATE

10.12.3 Content

Name	Data Type	Mandatory	Comment
TRADINGDATE	DATE	X	Trading Day for which this unit availability submission applies
DUID	VARCHAR2(20)	X	Unique Identifier of Dispatchable Unit
OFFERDATETIME	DATE	X	Date and Time when this unit availability submission was loaded
PARTICIPANTID	VARCHAR2(20)		Unique participant identifier
LASTCHANGED	DATE		Last date and time record changed
AUTHORISEDUSER	VARCHAR2(20)		User entering the unit availability submission

AUTHORISED BY PARTICIPANT ID	VARCHAR2(20)		Participant entering the unit availability submission
------------------------------	--------------	--	---

10.13 Table: INTERMITTENT_P5_PRED

10.13.1 INTERMITTENT_P5_PRED

Name INTERMITTENT_P5_PRED

Comment Unconstrained Intermittent Generation Forecasts (UIGF) for 5-Minute Pre-dispatch

10.13.2 Notes

Name	Comment	Value
Visibility	Data in this table is:	Private

10.13.3 Primary Key Columns

Name

DUID

FORECAST_PRIORITY

INTERVAL_DATETIME

OFFERDATETIME

ORIGIN

RUN_DATETIME

10.13.4 Content

Name	Data Type	Mandatory	Comment
RUN_DATETIME	DATE	X	Date and Time of the first interval of 5-Minute Pre-dispatch where the forecast applies (dispatch interval

			ending)
DUID	VARCHAR2(20)	X	DUID (or Area for non-scheduled) where this forecast applies
OFFERDATETIME	DATE	X	Date and Time when this forecast submission was loaded
INTERVAL_DATETIME	DATE	X	Interval within the current RUN_DATETIME where this forecast applies (dispatch interval ending)
ORIGIN	VARCHAR2(20)	X	Origin of this forecast (PARTICIPANTID, AWEFS/ASEFS, or another vendor)
FORECAST_PRIORITY	NUMBER(10,0)	X	Unsuppressed forecasts with higher priority values are used in 5-Minute Predispatch in preference to unsuppressed forecasts with lower priority values
FORECAST_MEAN	NUMBER(18,8)		Forecast MW value for this interval_DateTime
FORECAST_POE10	NUMBER(18,8)		Forecast 10% POE MW value for this interval_DateTime
FORECAST_POE50	NUMBER(18,8)		Forecast 50% POE MW value for this interval_DateTime.
FORECAST_POE90	NUMBER(18,8)		Forecast 90% POE MW value for this interval_DateTime

10.14 Table: INTERMITTENT_P5_RUN

10.14.1 INTERMITTENT_P5_RUN

Name	INTERMITTENT_P5_RUN
Comment	Unconstrained Intermittent Generation Forecasts (UIGF) for 5-Minute Pre-dispatch

10.14.2 Notes

Name	Comment	Value
Visibility	Data in this table is:	Private

10.14.3 Primary Key Columns

Name
 DUID
 FORECAST_PRIORITY
 OFFERDATETIME
 ORIGIN
 RUN_DATETIME

10.14.4 Content

Name	Data Type	Mandatory	Comment
RUN_DATETIME	DATE	X	Date and Time of the first interval of 5-minute pre-dispatch where the forecast applies.
DUID	Varchar2(20)	X	DUID (or Area for non-scheduled)

			where this forecast applies
OFFERDATETIME	DATE	X	Date and Time when this forecast submission was loaded
ORIGIN	Varchar2(20)	X	Origin of this forecast (PARTICIPANTID, AWEFS/ASEFS, or another vendor)
FORECAST_PRIORITY	NUMBER(10,0)	X	Unsuppressed forecasts with higher priority values are used in 5-Minute Predispatch in preference to unsuppressed forecasts with lower priority values
AUTHORISED_BY	Varchar2(20)		Authorising officer of this forecast
COMMENTS	Varchar2(200)		Comments relating to the forecast
LASTCHANGED	DATE		Last date and time the record changed.
MODEL	Varchar2(30)		Metadata relating to the forecast.
PARTICIPANT_TIMESTAMP	DATE		Participant can document when the forecast was created
SUPPRESSED_AEMO	NUMBER(1,0)		Was this forecast suppressed by AEMO? Suppressed = 1, Not suppressed = 0
SUPPRESSED_PARTICIPANT	NUMBER(1,0)		Was this forecast suppressed by the participant? Suppressed submissions may not be used, Suppressed = 1, Not suppressed = 0
TRANSACTION_ID	Varchar2(100)		Uniquely identifies this interaction

10.15 Table: MTPASA_INTERMITTENT_AVAIL

10.15.1 MTPASA_INTERMITTENT_AVAIL

Name MTPASA_INTERMITTENT_AVAIL

Comment A submission of expected plant availability for intermittent generators for use in MTPASA intermittent generation forecasts

10.15.2 Primary Key Columns

Name

CLUSTERID

DUID

OFFERDATETIME

TRADINGDATE

10.15.3 Content

Name	Data Type	Mandatory	Comment
TRADINGDATE	DATE	X	Trading Day for which this cluster availability submission applies
DUID	VARCHAR2(20)	X	Unique Identifier of Dispatchable Unit
OFFERDATETIME	DATE	X	Date and Time when this cluster availability submission was loaded
CLUSTERID	VARCHAR2(20)	X	Unique Cluster Identifier for this cluster within the DUID
LASTCHANGED	DATE		Last date and time record changed

ELEMENTS_UNAVAILABLE	NUMBER(3,0)		Number of elements within this CLUSTERID (turbines for wind, or inverters for solar) that are not available for this TRADINGDATE. Value between 0 and the registered Number of Cluster Elements. Value = 0 means no elements unavailable.
----------------------	-------------	--	---

10.16 Table: MTPASA_INTERMITTENT_LIMIT

10.16.1 MTPASA_INTERMITTENT_LIMIT

Name	MTPASA_INTERMITTENT_LIMIT
Comment	A submission of expected maximum availability for intermittent generators for use in MTPASA intermittent generation forecasts

10.16.2 Primary Key Columns

Name
DUID
OFFERDATETIME
TRADINGDATE

10.16.3 Content

Name	Data Type	Mandatory	Comment
TRADINGDATE	DATE	X	Trading Day for which this unit availability submission applies
DUID	VARCHAR2(20)	X	Unique Identifier of Dispatchable Unit
OFFERDATETIME	DATE	X	Date time file processed
LASTCHANGED	DATE		Last date and time record changed
UPPERMWLIMIT	NUMBER(6)		Maximum imposed MW limit. Value between 0 and the registered DUID Maximum Capacity. Value = -1 means no limit applies.

AUTHORISEDUSER	VARCHAR2(20)		User entering the unit availability submission
AUTHORISEDPARTICIPANTID	VARCHAR2(20)		Participant entering the unit availability submission

10.17 Table: PERDEMAND

10.17.1 PERDEMAND

Name	PERDEMAND
Comment	PERDEMAND sets out the regional demands and MR schedule data for each half-hour period. PERDEMAND is a child table to RESDEMANDTRK.

10.17.2 Description

The RESDEMANDTRK and PERDEMAND tables have a parent/child relationship, and define forecast regional demands since market start. RESDEMANDTRK defines the existence and versioning information of a forecast for a specific region and trading date. PERDEMAND defines the numerical forecast values for each trading interval of a the trading day for that region. A complete trading day forecast for one region consists of one RESDEMANDTRK record and 48 PERDEMAND records.

Source

PERDEMAND updates whenever AEMO issues a new or revised forecast. ST PASA forecasts update seven days at a time. Predispatch updates one date.

Volume

1296000 rows per year

Note

In the context of a mandatory restrictions event the forecast schedule (MW) of restrictions are reported through the RESDEMANDTRK and PERDEMAND tables using the new field PerDemand.MR_Schedule. The relationship between fields and mandatory restriction terms for the 50% probability of exceedence forecast are:

- UnRestricted Profile = ResDemand + MR_Schedule
- Restricted Profile = ResDemand

10.17.3 Notes

Name	Comment	Value
Visibility	Data in this table is:	Public

10.17.4 Primary Key Columns

Name

OFFERDATE

PERIODID

REGIONID

SETTLEMENTDATE

VERSIONNO

10.17.5 Index Columns

Name

LASTCHANGED

10.17.6 Content

Name	Data Type	Mandatory	Comment
EFFECTIVEDATE	DATE		Market date the forecast is made for. First date of the 7 days.
SETTLEMENTDATE	DATE	X	Market date of forecast up to 7 days ahead.
REGIONID	VARCHAR2(10)	X	Differentiates this region from all other regions
OFFERDATE	DATE	X	Date record issued
PERIODID	NUMBER(3,0)	X	Half hourly trading intervals from 04:30.
VERSIONNO	NUMBER(3,0)	X	The version of the RESDEMAND file for this date
RESDEMAND	NUMBER(10,0)		Base Demand forecast for period
DEMAND90PROBABILITY	NUMBER(10,0)		Demand at 90% probability of

			exceedance
DEMAND10PROBABILITY	NUMBER(10,0)		Demand level for a 10% probability of exceedance
LASTCHANGED	DATE		Last date and time record changed
MR_SCHEDULE	NUMBER(6,0)		MR_Schedule = Unrestricted Demand - POE

10.18 Table: RESDEMANDTRK

10.18.1 RESDEMANDTRK

Name	RESDEMANDTRK
Comment	<p>RESDEMANDTRK defines the existence and versioning information of a forecast for a specific region and trading date.</p> <p>RESDEMANDTRK and PERDEMAND have a parent/child relationship, and are for defined forecast regional demands since market start. RESDEMANDTRK defines the existence and versioning information of a forecast for a specific region and trading date. PERDEMAND defines the numerical forecast values for each trading interval of a the trading day for that region. A complete trading day forecast for one region consists of one RESDEMANDTRK record and 48 PERDEMAND records.</p>

10.18.2 Description

RESDEMANDTRK data is public, so is available to all participants.

Source

RESDEMANDTRK updates are ad hoc.

Volume

27000 rows per year.

10.18.3 Notes

Name	Comment	Value
Visibility	Data in this table is:	Public

10.18.4 Primary Key Columns

Name
EFFECTIVEDATE

OFFERDATE

REGIONID

VERSIONNO

10.18.5 Index Columns

Name

LASTCHANGED

10.18.6 Content

Name	Data Type	Mandatory	Comment
EFFECTIVEDATE	DATE	X	Trading Date of the regional forecast
REGIONID	VARCHAR2(10)	X	Unique RegionID
OFFERDATE	DATE	X	Date the forecast was created
VERSIONNO	NUMBER(3,0)	X	Version of this forecast with respect to the Effectivedate and Offerdate
FILENAME	VARCHAR2(40)		Tracking purposes only
AUTHORISEDDATE	DATE		Date forecast authorised
AUTHORISEDBY	VARCHAR2(10)		Identifier of authorising user
LASTCHANGED	DATE		Date and time the record was last modified

10.19 Table: ROOFTOP_PV_ACTUAL

10.19.1 ROOFTOP_PV_ACTUAL

Name ROOFTOP_PV_ACTUAL
 Comment Estimate of regional Rooftop Solar actual generation for each half-hour interval in a day

10.19.2 Notes

Name	Comment	Value
Visibility	Data in this table is:	Public

10.19.3 Primary Key Columns

Name
 INTERVAL_DATETIME
 REGIONID
 TYPE

10.19.4 Index Columns

Name
 INTERVAL_DATETIME
 TYPE
 REGIONID

10.19.5 Content

Name	Data Type	Manda	Comment
------	-----------	-------	---------

		tory	
INTERVAL_DATETIME	DATE	X	The forecast half-hour interval (time ending)
TYPE	VARCHAR2(20)	X	One of DAILY, MEASUREMENT or SATELLITE
REGIONID	VARCHAR2(20)	X	Region identifier
POWER	NUMBER(12,3)		Estimated generation in MW at the interval end
QI	NUMBER(2,1)		Quality indicator. Represents the quality of the estimate.
LASTCHANGED	DATE		Last date and time record changed

10.20 Table: ROOFTOP_PV_FORECAST

10.20.1 ROOFTOP_PV_FORECAST

Name ROOFTOP_PV_FORECAST

Comment Regional forecasts of Rooftop Solar generation across the half-hour intervals over 8 days

10.20.2 Notes

Name	Comment	Value
Visibility	Data in this table is:	Public

10.20.3 Primary Key Columns

Name

INTERVAL_DATETIME

REGIONID

VERSION_DATETIME

10.20.4 Index Columns

Name

VERSION_DATETIME

INTERVAL_DATETIME

REGIONID

10.20.5 Content

Name	Data Type	Manda	Comment
------	-----------	-------	---------

		tory	
VERSION_DATETIME	DATE	X	Date time this forecast was produced
REGIONID	VARCHAR2(20)	X	Region identifier
INTERVAL_DATETIME	DATE	X	The forecast half-hour interval (time ending)
POWERMEAN	NUMBER(12,3)		The average forecast value in MW at the interval end
POWERPOE50	NUMBER(12,3)		50% probability of exceedance forecast value in MW at the interval end
POWERPOELOW	NUMBER(12,3)		10% probability of exceedance forecast value in MW at the interval end
POWERPOEHIGH	NUMBER(12,3)		90% probability of exceedance forecast value in MW at the interval end
LASTCHANGED	DATE		Last date and time record changed

11 Package: DISPATCH

<i>Name</i>	DISPATCH
<i>Comment</i>	Results from a published Dispatch Run

11.1 List of tables

Name	Comment
CONSTRAINTRELAXATION_OCD	CONSTRAINTRELAXATION_OCD contains details of interconnector constraints and unit ancillary service constraints relaxed in the over-constrained dispatch (OCD) re-run for this interval (if there was one). Note: INTERVENTION is not included in CONSTRAINTRELAXATION_OCD, since the relaxation of the same constraint is the same amount in both intervened and non-intervened cases.
DISPATCH_CONSTRAINT_FCAS_OCD	FCAS constraint solution from OCD re-run.
DISPATCH_FCAS_REQ	DISPATCH_FCAS_REQ shows Dispatch Constraint tracking for Regional FCAS recovery.
DISPATCH_INTERCONNECTION	Inter-regional flow information common to or aggregated for regulated (i.e. not MNSP) Interconnectors spanning the From-Region and To-Region - NB only the physical run is calculated'
DISPATCH_LOCAL_PRICE	Sets out local pricing offsets associated with each DUID connection point for each dispatch period. Note that from 2014 Mid year release only records with non-zero Local_Price_Adjustment values are issued
DISPATCH_MNSPBIDTRK	DISPATCH_MNSPBIDTRK shows the MNSP bid tracking, including the bid version used in each dispatch run for

	<p>each MNSP Interconnector Link.</p> <p>DISPATCH_MNSPBIDTRK is the audit trail of the bids actually used for each dispatch run.</p>
DISPATCH_MR_SCHEDULE_TRK	<p>DISPATCH_MR_SCHEDULE_TRK records the Mandatory Restrictions Acceptance Schedule applied to this dispatch interval for this region.</p> <p>DISPATCH_MR_SCHEDULE_TRK is populated by the Dispatch process and records the MR Offer Stack applied in each dispatch interval.</p> <p>DISPATCH_MR_SCHEDULE_TRK is used by Settlements to calculate payments according to the correct MR offer stack.</p>
DISPATCH_PRICE_REVISION	<p>An audit trail of price changes on the DISPATCHPRICE table (i.e. for 5 minute dispatch prices for energy and FCAS).</p>
DISPATCH_UNIT_CONFORMANCE	<p>DISPATCH_UNIT_CONFORMANCE details the conformance of a scheduled units operation with respect to a cleared target on dispatch interval basis.</p> <p>Data is confidential</p>
DISPATCH_UNIT_SCADA	<p>Dispatchable unit MW from SCADA at the start of the dispatch interval. The table includes all scheduled and semi-scheduled (and non-scheduled units where SCADA is available)</p>
DISPATCHBLOCKEDCONSTRAINT	<p>DISPATCH Blocked Constraints lists any constraints that were blocked in a dispatch run. If no constraints are blocked, there will be no rows for that dispatch run.</p>
DISPATCHCASESOLUTION	<p>DISPATCHCASESOLUTION shows information relating to the complete dispatch run. The fields in DISPATCHCASESOLUTION provide an overview of the dispatch run results allowing immediate identification of conditions such as energy or FCAS deficiencies.</p>
DISPATCHCONSTRAINT	<p>DISPATCHCONSTRAINT sets out details of all binding</p>

	and interregion constraints in each dispatch run. Note: invoked constraints can be established from GENCONSETINVOKE. Binding constraints show as marginal value >\$0. Interconnector constraints are listed so RHS (SCADA calculated limits) can be reported.
DISPATCHINTERCONNECTORRES	DISPATCHINTERCONNECTORRES sets out MW flow and losses on each interconnector for each dispatch period, including fields for the Frequency Controlled Ancillary Services export and import limits and extra reporting of the generic constraints set the energy import and export limits.
DISPATCHLOAD	DISPATCHLOAD set out the current SCADA MW and target MW for each dispatchable unit, including relevant Frequency Control Ancillary Services (FCAS) enabling targets for each five minutes and additional fields to handle the new Ancillary Services functionality. Fast Start Plant status is indicated by dispatch mode.
DISPATCHOFFERTRK	DISPATCHOFFERTRK is the energy and ancillary service bid tracking table for the Dispatch process. The table identifies which bids from BIDDAYOFFER and BIDPEROFFER were applied for a given unit and bid type for each dispatch interval.
DISPATCHPRICE	DISPATCHPRICE records 5 minute dispatch prices for energy and FCAS, including whether an intervention has occurred, or price override (e.g. for Administered Price Cap). DISPATCHPRICE updates when price adjustments occur, in which case the new price is written to the RRP field, and the old price to the ROP field as an audit trail.
DISPATCHREGIONSUM	DISPATCHREGIONSUM sets out the 5-minute solution for each dispatch run for each region, including the Frequency Control Ancillary Services (FCAS) services provided. Additional fields are for the Raise Regulation and Lower Regulation Ancillary Services plus improvements to demand calculations.
INTERMITTENT_FORECAST_TRK	Uniquely tracks which Intermittent Generation forecast

	was used for the DUID in which Dispatch run
NEGATIVE_RESIDUE	Shows the inputs provided to the Negative Residue Constraints in the Dispatch horizon

11.2 Diagram: Entities: Dispatch

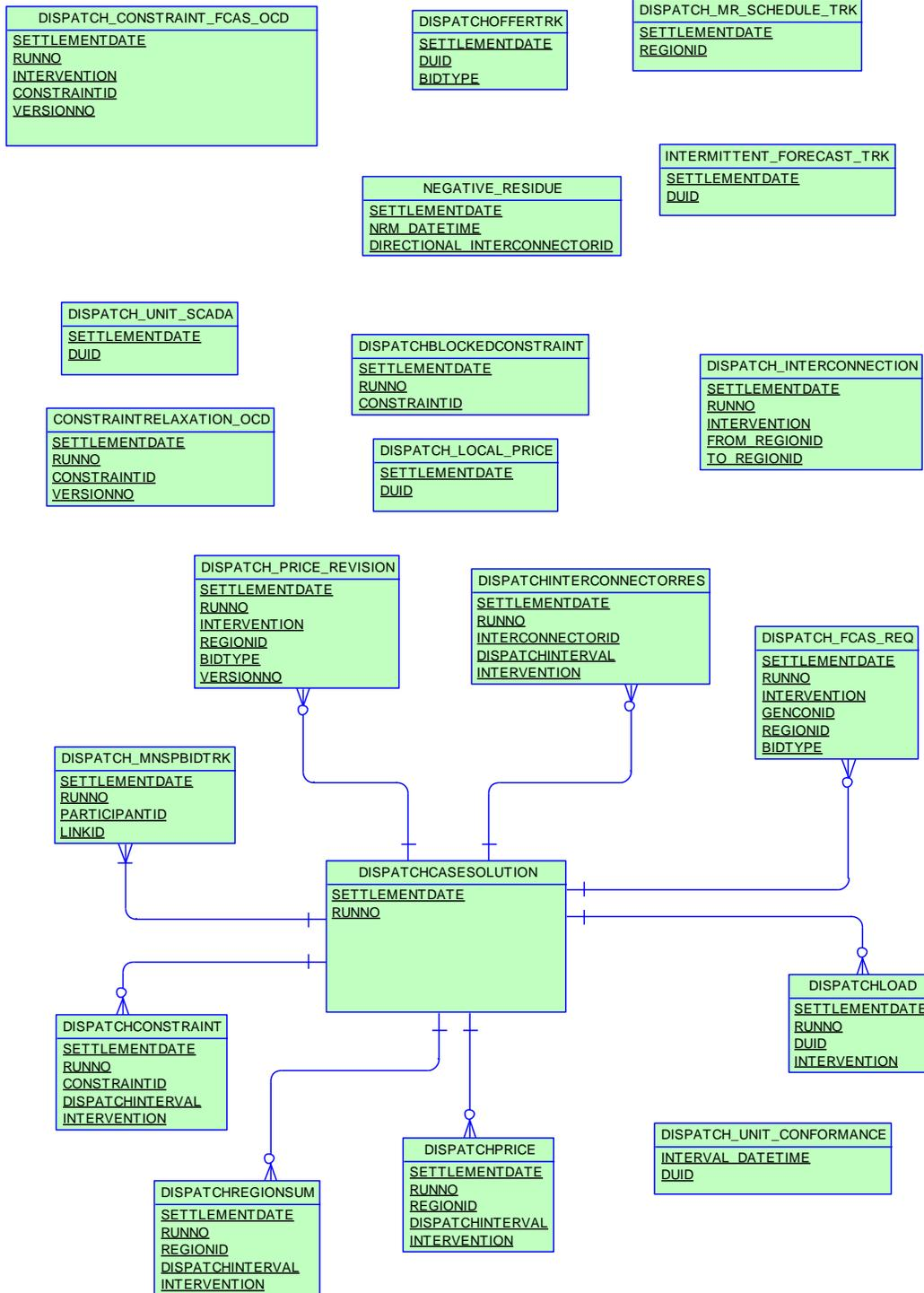

11.3 Table: CONSTRAINTRELAXATION_OCD

11.3.1 CONSTRAINTRELAXATION_OCD

Name	CONSTRAINTRELAXATION_OCD
Comment	<p>CONSTRAINTRELAXATION_OCD contains details of interconnector constraints and unit ancillary service constraints relaxed in the over-constrained dispatch (OCD) re-run for this interval (if there was one).</p> <p>Note: INTERVENTION is not included in CONSTRAINTRELAXATION_OCD, since the relaxation of the same constraint is the same amount in both intervened and non-intervened cases.</p>

11.3.2 Description

Source

The occurrences of Over-Constrained Dispatch (OCD) re-runs are ad hoc, with significant dependencies on the configuration or events in the physical power system.

Over-constrained dispatch (OCD) re-run (if there was one).

Volume

Rows per day: ~2

Mb per month: <1

The estimates on the number of rows are based on a 1% occurrence rate for OCD runs.

11.3.3 Notes

Name	Comment	Value
Visibility	Data in this table is:	Public

11.3.4 Primary Key Columns

Name	CONSTRAINTID
------	--------------

RUNNO

SETTLEMENTDATE

VERSIONNO

11.3.5 Index Columns

Name

LASTCHANGED

11.3.6 Content

Name	Data Type	Mandatory	Comment
SETTLEMENTDATE	DATE	X	End date and time of the dispatch interval
RUNNO	NUMBER(3,0)	X	Dispatch run no
CONSTRAINTID	VARCHAR2(20)	X	Constraint identifier
RHS	NUMBER(16,6)		Relaxed RHS used in attempt to avoid constraint violation
LASTCHANGED	DATE		Last date and time record changed
VERSIONNO	NUMBER(3,0)	X	Version Number

11.4 Table: DISPATCH_CONSTRAINT_FCAS_OCD

11.4.1 DISPATCH_CONSTRAINT_FCAS_OCD

Name DISPATCH_CONSTRAINT_FCAS_OCD
 Comment FCAS constraint solution from OCD re-run.

11.4.2 Notes

Name	Comment	Value
Visibility	Data in this table is:	Public

11.4.3 Primary Key Columns

Name
 CONSTRAINTID
 INTERVENTION
 RUNNO
 SETTLEMENTDATE
 VERSIONNO

11.4.4 Index Columns

Name
 LASTCHANGED

11.4.5 Content

Name	Data Type	Mandatory	Comment

SETTLEMENTDATE	DATE	X	Dispatch interval that the prices were loaded to
RUNNO	NUMBER(3)	X	Dispatch run no; always 1
INTERVENTION	NUMBER(2)	X	Intervention 0/1
CONSTRAINTID	VARCHAR2(20)	X	ConstraintID/GenconID
VERSIONNO	NUMBER(3)	X	VersionNo
LASTCHANGED	DATE		The datetime that the record was last changed
RHS	NUMBER(15,5)		RHS from OCD re-run
MARGINALVALUE	NUMBER(15,5)		marginalvalue from OCD re-run
VIOLATIONDEGREE	NUMBER(15,5)		The violation degree of this constraint in the solution result

11.5 Table: DISPATCH_FCAS_REQ

11.5.1 DISPATCH_FCAS_REQ

Name	DISPATCH_FCAS_REQ
Comment	DISPATCH_FCAS_REQ shows Dispatch Constraint tracking for Regional FCAS recovery.

11.5.2 Description

DISPATCH_FCAS_REQ is public data and is available to all participants.

Source

DISPATCH_FCAS_REQ updates with each dispatch run (5 minutes).

Volume

Approximately 10,000 rows per day

11.5.3 Notes

Name	Comment	Value
Visibility	Data in this table is:	Public

11.5.4 Primary Key Columns

Name

BIDTYPE

GENCONID

INTERVENTION

REGIONID

RUNNO

SETTLEMENTDATE

11.5.5 Index Columns

Name

LASTCHANGED

11.5.6 Content

Name	Data Type	Mandatory	Comment
SETTLEMENTDATE	DATE	X	Settlement date and time of Dispatch Interval
RUNNO	NUMBER(3,0)	X	Dispatch run no; always 1
INTERVENTION	NUMBER(2,0)	X	Intervention Flag
GENCONID	VARCHAR2(20)	X	Generic Constraint ID - Join to table GenConData
REGIONID	VARCHAR2(10)	X	
BIDTYPE	VARCHAR2(10)	X	DUID offered type
GENCONEFFECTIVEDATE	DATE		Generic Constraint EffectiveDate - Join to table GenConData
GENCONVERSIONNO	NUMBER(3,0)		Generic Constraint Version number - Join to table GenConData
MARGINALVALUE	NUMBER(16,6)		
LASTCHANGED	DATE		Date record is changed
BASE_COST	NUMBER(18,8)		The base cost of the constraint for this service, before the

			regulation/contingency split
ADJUSTED_COST	NUMBER(18,8)		The adjusted cost of the constraint for this service, before the regulation/contingency split
ESTIMATED_CMPF	NUMBER(18,8)		An estimated value for the constraint CMPF, based on dispatched data
ESTIMATED_CRMPF	NUMBER(18,8)		An estimated value for the constraint CRMPF, based on dispatched data
RECOVERY_FACTOR_CMPF	NUMBER(18,8)		Estimated recovery factor for CMPF based recovery
RECOVERY_FACTOR_CRMPF	NUMBER(18,8)		Estimated recovery factor for CRMPF based recovery

11.6 Table: DISPATCH_INTERCONNECTION

11.6.1 DISPATCH_INTERCONNECTION

Name DISPATCH_INTERCONNECTION

Comment Inter-regional flow information common to or aggregated for regulated (i.e. not MNSP) Interconnectors spanning the From-Region and To-Region - NB only the physical run is calculated'

11.6.2 Notes

Name	Comment	Value
Visibility	Data in this table is:	Public

11.6.3 Primary Key Columns

Name

FROM_REGIONID

INTERVENTION

RUNNO

SETTLEMENTDATE

TO_REGIONID

11.6.4 Content

Name	Data Type	Mandatory	Comment
SETTLEMENTDATE	DATE	X	Market date starting at 04:05
RUNNO	NUMBER(3,0)	X	Dispatch run no; always 1

INTERVENTION	NUMBER(2,0)	X	Intervention case or not
FROM_REGIONID	VARCHAR2(20)	X	Nominated RegionID from which the energy flows
TO_REGIONID	VARCHAR2(20)	X	Nominated RegionID to which the energy flows
DISPATCHINTERVAL	NUMBER(22,0)		Dispatch period identifier, from 001 to 288 in format YYYYMMDDPPP
IRLF	NUMBER(15,5)		Inter-Regional Loss Factor. Calculated based on the MWFLOW and the nominal From and To Region losses.
MWFLOW	NUMBER(16,6)		Summed MW flow of the parallel regulated Interconnectors
METEREDMWFLOW	NUMBER(16,6)		Summed Metered MW flow of the parallel regulated Interconnectors
FROM_REGION_MW_LOSSES	NUMBER(16,6)		Losses across the Interconnection attributable to the nominal From Region
TO_REGION_MW_LOSSES	NUMBER(16,6)		Losses across the Interconnection attributable to the nominal To Region
LASTCHANGED	DATE		The datetime that the record was last changed

11.7 Table: DISPATCH_LOCAL_PRICE

11.7.1 DISPATCH_LOCAL_PRICE

Name DISPATCH_LOCAL_PRICE

Comment Sets out local pricing offsets associated with each DUID connection point for each dispatch period. Note that from 2014 Mid year release only records with non-zero Local_Price_Adjustment values are issued

11.7.2 Notes

Name	Comment	Value
Visibility	Data in this table is:	Private; Public Next-Day

11.7.3 Primary Key Columns

Name

DUID

SETTLEMENTDATE

11.7.4 Index Columns

Name

SETTLEMENTDATE

DUID

11.7.5 Content

Name	Data Type	Mandatory	Comment
------	-----------	-----------	---------

SETTLEMENTDATE	DATE	X	Market date time starting at 04:05
DUID	VARCHAR2(20)	X	Dispatchable unit identifier
LOCAL_PRICE_ADJUSTMENT	NUMBER(10,2)		Aggregate Constraint contribution cost of this unit: Sum(MarginalValue x Factor) for all relevant Constraints
LOCALLY_CONSTRAINED	NUMBER(1,0)		Key for Local_Price_Adjustment: 2 = at least one Outage Constraint; 1 = at least 1 System Normal Constraint (and no Outage Constraint); 0 = No System Normal or Outage Constraints

11.8 Table: DISPATCH_MNSPBIDTRK

11.8.1 DISPATCH_MNSPBIDTRK

Name	DISPATCH_MNSPBIDTRK
Comment	DISPATCH_MNSPBIDTRK shows the MNSP bid tracking, including the bid version used in each dispatch run for each MNSP Interconnector Link. DISPATCH_MNSPBIDTRK is the audit trail of the bids actually used for each dispatch run.

11.8.2 Description

DISPATCH_MNSPBIDTRK shows own details for participant as they occur, with all details until close of business yesterday being available to all participants after end of day.

Source

DISPATCH_MNSPBIDTRK potentially updates every 5 minutes.

Volume

220, 000 per year

11.8.3 Notes

Name	Comment	Value
Visibility	Data in this table is:	Private; Public Next-Day

11.8.4 Primary Key Columns

- Name
- LINKID
- PARTICIPANTID
- RUNNO
- SETTLEMENTDATE

11.8.5 Index Columns

Name

LASTCHANGED

11.8.6 Content

Name	Data Type	Mandatory	Comment
SETTLEMENTDATE	DATE	X	Market date starting at 04:05
RUNNO	NUMBER(3,0)	X	Dispatch run no; always 1
PARTICIPANTID	VARCHAR2(10)	X	Participant that owns unit during effective record period
LINKID	VARCHAR2(10)	X	Identifier for each of the two MNSP Interconnector Links. Each link pertains to the direction from and to.
OFFERSETTLEMENTDATE	DATE		Offer date for bid
OFFEREFFECTIVEDATE	DATE		Date the bid/offer becomes effective
OFFERVERSIONNO	NUMBER(3,0)		VersionNo of the bid/offer used
LASTCHANGED	DATE		Record creation timestamp

11.9 Table: DISPATCH_MR_SCHEDULE_TRK

11.9.1 DISPATCH_MR_SCHEDULE_TRK

Name	DISPATCH_MR_SCHEDULE_TRK
Comment	DISPATCH_MR_SCHEDULE_TRK records the Mandatory Restrictions Acceptance Schedule applied to this dispatch interval for this region. DISPATCH_MR_SCHEDULE_TRK is populated by the Dispatch process and records the MR Offer Stack applied in each dispatch interval. DISPATCH_MR_SCHEDULE_TRK is used by Settlements to calculate payments according to the correct MR offer stack.

11.9.2 Description

DISPATCH_MR_SCHEDULE_TRK data is public to all participants.

Source

DISPATCH_MR_SCHEDULE_TRK updates are ad hoc.

Volume

2 rows per year.

11.9.3 Notes

Name	Comment	Value
Visibility	Data in this table is:	Public

11.9.4 Primary Key Columns

- Name
- REGIONID
- SETTLEMENTDATE

11.9.5 Index Columns

Name

LASTCHANGED

11.9.6 Content

Name	Data Type	Mandatory	Comment
SETTLEMENTDATE	DATE	X	Date Time of the Dispatch Interval
REGIONID	VARCHAR2(10)	X	Unique RegionID; Key reference to MR_Event_Schedule
MR_DATE	DATE		Mandatory Restriction date; Key reference to MR_Event_Schedule table
VERSION_DATETIME	DATE		Date Time the MR acceptance stack was created; Key reference to MR_Event_Schedule table
LASTCHANGED	DATE		Date and time the record was last inserted/modified

11.10 Table: DISPATCH_PRICE_REVISION

11.10.1 DISPATCH_PRICE_REVISION

Name	DISPATCH_PRICE_REVISION
Comment	An audit trail of price changes on the DISPATCHPRICE table (i.e. for 5 minute dispatch prices for energy and FCAS).

11.10.2 Notes

Name	Comment	Value
Visibility	Data in this table is:	Public

11.10.3 Primary Key Columns

Name

BIDTYPE

INTERVENTION

REGIONID

RUNNO

SETTLEMENTDATE

VERSIONNO

11.10.4 Index Columns

Name

LASTCHANGED

11.10.5 Content

Name	Data Type	Mandatory	Comment
SETTLEMENTDATE	DATE	X	Market date and time starting at 04:05
RUNNO	NUMBER(3,0)	X	Dispatch run no; always 1
INTERVENTION	NUMBER(2,0)	X	Manual intervention flag; always 0
REGIONID	VARCHAR2(10)	X	Affected Region Identifier
BIDTYPE	VARCHAR2(10)	X	Affected Bid Type Identifier
VERSIONNO	NUMBER(3)	X	Version No of price revision for this settlement date
RRP_NEW	NUMBER(15,5)		New RRP in DISPATCHPRICE table
RRP_OLD	NUMBER(15,5)		Old RRP from DISPATCHPRICE table
LASTCHANGED	DATE		The datetime the record was last changed

11.11 Table: DISPATCH_UNIT_CONFORMANCE

11.11.1 DISPATCH_UNIT_CONFORMANCE

Name	DISPATCH_UNIT_CONFORMANCE
Comment	DISPATCH_UNIT_CONFORMANCE details the conformance of a scheduled units operation with respect to a cleared target on dispatch interval basis. Data is confidential

11.11.2 Description

DISPATCH_UNIT_CONFORMANCE data is confidential.

Source

DISPATCH_UNIT_CONFORMANCE shows data for every 5 minutes for all scheduled units

Volume

Rows per day: 288 per scheduled unit

11.11.3 Notes

Name	Comment	Value
Visibility	Data in this table is:	Private

11.11.4 Primary Key Columns

Name
DUID
INTERVAL_DATETIME

11.11.5 Index Columns

Name
LASTCHANGED

11.11.6 Content

Name	Data Type	Mandatory	Comment
INTERVAL_DATETIME	DATE	X	Dispatch Interval that the conformance data applies to
DUID	VARCHAR2(20)	X	Dispatchable Unit Identifier
TOTALCLEARED	NUMBER(16,6)		Dispatch Target - MW
ACTUALMW	NUMBER(16,6)		Unit output measured at the conclusion of the dispatch interval - MW (MWB)
ROC	NUMBER(16,6)		Rate of Change in direction of error MW per hour
AVAILABILITY	NUMBER(16,6)		Offered unit capacity - MW (MWO)
LOWERREG	NUMBER(16,6)		Lower Regulation FCAS enabled - MW (FCL)
RAISEREG	NUMBER(16,6)		Raise Regulation FCAS enabled - MW (FCR)
STRIGLM	NUMBER(16,6)		Calculated small trigger error limit in MW
LTRIGLM	NUMBER(16,6)		Calculated large trigger error limit in MW
MWERROR	NUMBER(16,6)		Calculated actual error
MAX_MWERROR	NUMBER(16,6)		Max of mwerror while that unit was not in a normal state
LECOUNT	NUMBER(6)		Large trigger error count. Reset when mwerror changes sign

SECOUNT	NUMBER(6)		Small trigger error count. Reset when mwerror changes sign
STATUS	VARCHAR2(20)		Unit conformance status. NORMAL OFF-TARGET NOT-RESPONDING NC-PENDING NON-CONFORMING SUSPENDED
PARTICIPANT_STATUS_ACTION	VARCHAR2(100)		Participant action required in response to current STATUS
OPERATING_MODE	VARCHAR2(20)		conformance operating mode MANUAL AUTO
LASTCHANGED	DATE		Last date and time record changed

11.12 Table: DISPATCH_UNIT_SCADA

11.12.1 DISPATCH_UNIT_SCADA

Name	DISPATCH_UNIT_SCADA
Comment	Dispatchable unit MW from SCADA at the start of the dispatch interval. The table includes all scheduled and semi-scheduled (and non-scheduled units where SCADA is available)

11.12.2 Description

DISPATCH_UNIT_SCADA data is public data, and is available to all participants.

Source

DISPATCH_UNIT_SCADA shows data for every 5 minutes for all scheduled units

Volume

Rows per day: 288 per each scheduled, semi-scheduled (and non-scheduled unit where SCADA is available)

11.12.3 Notes

Name	Comment	Value
Visibility	Data in this table is:	Public

11.12.4 Primary Key Columns

- Name
- DUID
- SETTLEMENTDATE

11.12.5 Index Columns

- Name
- SETTLEMENTDATE

DUID

11.12.6 Content

Name	Data Type	Mandatory	Comment
SETTLEMENTDATE	Date	X	Date Time of the Dispatch Interval
DUID	varchar2(20)	X	Dispatchable Unit Identifier
SCADAVALUE	Number(16,6)		Instantaneous MW reading from SCADA at the start of the Dispatch interval

11.13 Table: DISPATCHBLOCKEDCONSTRAINT

11.13.1 DISPATCHBLOCKEDCONSTRAINT

Name DISPATCHBLOCKEDCONSTRAINT

Comment DISPATCH Blocked Constraints lists any constraints that were blocked in a dispatch run. If no constraints are blocked, there will be no rows for that dispatch run.

11.13.2 Notes

Name	Comment	Value
Visibility	Data in this table is:	Public

11.13.3 Primary Key Columns

Name

CONSTRAINTID

RUNNO

SETTLEMENTDATE

11.13.4 Content

Name	Data Type	Mandatory	Comment
SETTLEMENTDATE	DATE	X	Dispatch Interval
RUNNO	NUMBER(3,0)	X	Dispatch run no; always 1
CONSTRAINTID	VARCHAR2(20)	X	Generic Constraint identifier (synonymous with GenConID)

11.14 Table: DISPATCHCASESOLUTION

11.14.1 DISPATCHCASESOLUTION

Name	DISPATCHCASESOLUTION
Comment	DISPATCHCASESOLUTION shows information relating to the complete dispatch run. The fields in DISPATCHCASESOLUTION provide an overview of the dispatch run results allowing immediate identification of conditions such as energy or FCAS deficiencies.

11.14.2 Description

The DISPATCHCASESOLUTION data is public.

Source

DISPATCHCASESOLUTION updates every 5 minutes.

Volume

Approximately 288 records per day.

11.14.3 Notes

Name	Comment	Value
Visibility	Data in this table is:	Public

11.14.4 Primary Key Columns

- Name
- RUNNO
- SETTLEMENTDATE

11.14.5 Index Columns

- Name
- LASTCHANGED

11.14.6 Content

Name	Data Type	Mandatory	Comment
SETTLEMENTDATE	DATE	X	Date and time of the dispatch interval (e.g. five minute dispatch interval ending 28/09/2000 16:35)
RUNNO	NUMBER(3,0)	X	Dispatch run no; always 1
INTERVENTION	NUMBER(2,0)	X	Intervention flag - refer to package documentation for definition and practical query examples
CASESUBTYPE	VARCHAR2(3)		Overconstrained dispatch indicator: * OCD = detecting over-constrained dispatch * null = no special condition
SOLUTIONSTATUS	NUMBER(2,0)		If non-zero indicated one of the following conditions: * 1 = Supply Scarcity, Excess generation or constraint violations * X = Model failure
SPDVERSION	VARCHAR2(20)		Current version of SPD
NONPHYSICALLOSSES	NUMBER(1,0)		Non-Physical Losses algorithm invoked occurred during this run
TOTALOBJECTIVE	NUMBER(27,10)		The Objective function from the LP
TOTALAREAGENVIO LATION	NUMBER(15,5)		Total Region Demand violations

TOTALINTERCONNECTORVIOLATION	NUMBER(15,5)		Total interconnector violations
TOTALGENERICVIOLATION	NUMBER(15,5)		Total generic constraint violations
TOTALRAMPRATEVIOLATION	NUMBER(15,5)		Total ramp rate violations
TOTALUNITMWCAPACITYVIOLATION	NUMBER(15,5)		Total unit capacity violations
TOTAL5MINVIOLATION	NUMBER(15,5)		Total of 5 minute ancillary service region violations
TOTALREGVIOLATION	NUMBER(15,5)		Total of Regulation ancillary service region violations
TOTAL6SECVIOLATION	NUMBER(15,5)		Total of 6 second ancillary service region violations
TOTAL60SECVIOLATION	NUMBER(15,5)		Total of 60 second ancillary service region violations
TOTALASPROFILEVIOLATION	NUMBER(15,5)		Total of ancillary service trader profile violations
TOTALFASTSTARTVIOLATION	NUMBER(15,5)		Total of fast start trader profile violations
TOTALENERGYOFFERVIOLATION	NUMBER(15,5)		Total of unit summated offer band violations
LASTCHANGED	DATE		Last date and time record changed
SWITCHRUNINITIALSTATUS	NUMBER(1,0)		Flag indicating the SCADA status for FCAS Interconnector dead-band. "0" if SCADA Status or requesting Constraint not invoked. "1" if SCADA Status AND requesting Constraint is invoked
SWITCHRUNBESTSTATUS	NUMBER(1,0)		Flag indicating which Switch run

			was used for the Solution – from PeriodSolution
SWITCHRUNBESTSTATUS_I NT	NUMBER(1,0)		Flag indicating which Switch run was used for the Intervention Physical Solution - from PeriodSolution

11.15 Table: DISPATCHCONSTRAINT

11.15.1 DISPATCHCONSTRAINT

Name	DISPATCHCONSTRAINT
Comment	DISPATCHCONSTRAINT sets out details of all binding and interregion constraints in each dispatch run. Note: invoked constraints can be established from GENCONSETINVOKE. Binding constraints show as marginal value >\$0. Interconnector constraints are listed so RHS (SCADA calculated limits) can be reported.

11.15.2 Description

DISPATCHCONSTRAINT is public data, and is available to all participants.

Source

DISPATCHCONSTRAINT updates every five minutes.

11.15.3 Notes

Name	Comment	Value
Visibility	Data in this table is:	Private; Public Next-Day

11.15.4 Primary Key Columns

Name

CONSTRAINTID

DISPATCHINTERVAL

INTERVENTION

RUNNO

SETTLEMENTDATE

11.15.5 Index Columns

Name

LASTCHANGED

11.15.6 Index Columns

Name

SETTLEMENTDATE

11.15.7 Content

Name	Data Type	Mandatory	Comment
SETTLEMENTDATE	DATE	X	Market date starting at 04:05
RUNNO	NUMBER(3,0)	X	Dispatch run no; always 1
CONSTRAINTID	VARCHAR2(20)	X	Generic Constraint identifier (synonymous with GenConID)
DISPATCHINTERVAL	NUMBER(22,0)	X	Dispatch period identifier, from 001 to 288 in format YYYYMMDDPPP.
INTERVENTION	NUMBER(2,0)	X	Manual Intervention flag, which, if set (1), causes predispatch to solve twice.
RHS	NUMBER(15,5)		Right hand Side value as used in dispatch.
MARGINALVALUE	NUMBER(15,5)		\$ Value of binding constraint
VIOLATIONDEGREE	NUMBER(15,5)		Degree of violation in MW
LASTCHANGED	DATE		Last date and time record changed

DUID	VARCHAR2(20))		DUID to which the Constraint is confidential. Null denotes non-confidential
GENCONID_EFFECTIVEDATE	DATE		Effective date of the Generic Constraint (ConstraintID). This field is used to track the version of this generic constraint applied in this dispatch interval
GENCONID_VERSIONNO	NUMBER(22,0)		Version number of the Generic Constraint (ConstraintID). This field is used to track the version of this generic constraint applied in this dispatch interval
LHS	number(15,5)		Aggregation of the constraints LHS term solution values

11.16 Table: DISPATCHINTERCONNECTORRES

11.16.1 DISPATCHINTERCONNECTORRES

Name	DISPATCHINTERCONNECTORRES
Comment	DISPATCHINTERCONNECTORRES sets out MW flow and losses on each interconnector for each dispatch period, including fields for the Frequency Controlled Ancillary Services export and import limits and extra reporting of the generic constraints set the energy import and export limits.

11.16.2 Description

DISPATCHINTERCONNECTORRES is public data, and is available to all participants.

Source

DISPATCHINTERCONNECTORRES updates every 5 minutes.

Note

MW losses can be negative depending on the flow.
The definition of direction of flow for an interconnector is that positive flow starts from the FROMREGION in the INTERCONNECTOR table.

11.16.3 Notes

Name	Comment	Value
Visibility	Data in this table is:	Public

11.16.4 Primary Key Columns

- Name
- DISPATCHINTERVAL
- INTERCONNECTORID
- INTERVENTION
- RUNNO

SETTLEMENTDATE

11.16.5 Index Columns

Name

LASTCHANGED

11.16.6 Content

Name	Data Type	Mandatory	Comment
SETTLEMENTDATE	DATE	X	Market date starting at 04:05
RUNNO	NUMBER(3,0)	X	Dispatch run no; always 1
INTERCONNECTORID	VARCHAR2(10)	X	Interconnector identifier
DISPATCHINTERVAL	NUMBER(22,0)	X	Dispatch period identifier, from 001 to 288 in format YYYYMMDDPPP.
INTERVENTION	NUMBER(2,0)	X	Intervention case or not
METEREDMWFLOW	NUMBER(15,5)		Metered MW Flow from SCADA.
MWFLOW	NUMBER(15,5)		Target MW Flow for next 5 mins.
MWLOSSES	NUMBER(15,5)		Calculated MW Losses
MARGINALVALUE	NUMBER(15,5)		Shadow price resulting from thermal or reserve sharing constraints on Interconnector import/export (0 unless binding) - NEMDE Solution InterconnectorSolution element "Price" attribute

VIOATIONDEGREE	NUMBER(15,5)		Degree of violation on interconnector constraints
LASTCHANGED	DATE		Last changed.
EXPORTLIMIT	NUMBER(15,5)		Calculated export limit applying to energy only.
IMPORTLIMIT	NUMBER(15,5)		Calculated import limit applying to energy only.
MARGINALLOSS	NUMBER(15,5)		Marginal loss factor. Use this to adjust prices between regions.
EXPORTGENCONID	VARCHAR2(20)		Generic Constraint setting the export limit
IMPORTGENCONID	VARCHAR2(20)		Generic Constraint setting the import limit
FCASEXPORTLIMIT	NUMBER(15,5)		Calculated export limit applying to energy + FCAS.
FCASIMPORTLIMIT	NUMBER(15,5)		Calculated import limit applying to energy + FCAS.
LOCAL_PRICE_ADJUSTMENT_EXPORT	NUMBER(10,2)		Aggregate Constraint contribution cost of this Interconnector: Sum(MarginalValue x Factor) for all relevant Constraints, for Export (Factor >= 0)
LOCALLY_CONSTRAINED_EXPORT	NUMBER(1,0)		Key for Local_Price_Adjustment_Export: 2 = at least one Outage Constraint; 1 = at least 1 System Normal Constraint (and no Outage Constraint); 0 = No System Normal or Outage Constraints
LOCAL_PRICE_ADJUSTMENT_IMPORT	NUMBER(10,2)		Aggregate Constraint contribution cost of this Interconnector:

			Sum(MarginalValue x Factor) for all relevant Constraints, for Import (Factor >= 0)
LOCALLY_CONSTRAINED_IMPORT	NUMBER(1,0)		Key for Local_Price_Adjustment_Import: 2 = at least one Outage Constraint; 1 = at least 1 System Normal Constraint (and no Outage Constraint); 0 = No System Normal or Outage Constraints

11.17 Table: DISPATCHLOAD

11.17.1 DISPATCHLOAD

Name DISPATCHLOAD

Comment DISPATCHLOAD set out the current SCADA MW and target MW for each dispatchable unit, including relevant Frequency Control Ancillary Services (FCAS) enabling targets for each five minutes and additional fields to handle the new Ancillary Services functionality. Fast Start Plant status is indicated by dispatch mode.

11.17.2 Description

DISPATCHLOAD data is confidential for the current day, showing own details for participant and becomes public after close of business yesterday, and is available to all participants.

Source

DISPATCHLOAD shows data for every 5 minutes for all units, even zero targets.

Volume

Expect 40-50,000 records per day. All units are repeated, even zero targets.

Note

** A flag exists for each ancillary service type such that a unit trapped or stranded in one or more service type can be immediately identified. The flag is defined using the low 3 bits as follows:

Flag Name	Bit	Description
Enabled	0	The unit is enabled to provide this ancillary service type.
Trapped	1	The unit is enabled to provide this ancillary service type, however the profile for this service type is causing the unit to be trapped in the energy market.
Stranded	2	The unit is bid available to provide this ancillary service type, however, the unit is operating in the energy market outside of the profile for this service type and is stranded from providing this service.

Interpretation of the bit-flags as a number gives the following possibilities (i.e. other combinations are not possible):

Numeric Value	Bit (2,1,0)	Meaning
0	000	Not stranded, not trapped, not enabled (i.e. is unavailable).
1	001	Not stranded, not trapped, is enabled (i.e. available).
3	011	Not stranded, is trapped, is enabled (i.e. trapped).
4	100	Is stranded, not trapped, not enabled (i.e. stranded).

For example, testing for availability can be done by checking for odd (=available) or even (=unavailable) number (e.g. $\text{mod}(\text{flag}, 2)$ results in 0 for unavailable and 1 for available).

*** "Actual FCAS availability" is determined in a post-processing step based on the energy target (TotalCleared) and bid FCAS trapezium for that interval. However, if the unit is outside the bid FCAS trapezium at the start of the interval (InitialMW), the "Actual FCAS availability" is set to zero. For regulation services, the trapezium is the most restrictive of the bid/SCADA trapezium values.

11.17.3 Notes

Name	Comment	Value
Visibility	Data in this table is:	Private; Public Next-Day

11.17.4 Primary Key Columns

Name
 DUID
 INTERVENTION
 RUNNO
 SETTLEMENTDATE

11.17.5 Index Columns

Name
 LASTCHANGED

11.17.6 Index Columns

Name
 DUID
 LASTCHANGED

11.17.7 Content

Name	Data Type	Mandatory	Comment
SETTLEMENTDATE	DATE	X	Market date and time starting at 04:05

RUNNO	NUMBER(3,0)	X	Dispatch run no; always 1
DUID	VARCHAR2(10))	X	Dispatchable unit identifier
TRADETYPE	NUMBER(2,0)		Not used
DISPATCHINTERVAL	NUMBER(22,0)		Dispatch period identifier, from 001 to 288 in format YYYYMMDDPPP.
INTERVENTION	NUMBER(2,0)	X	Intervention flag if intervention run
CONNECTIONPOINTID	VARCHAR2(12))		Connection point identifier for DUID
DISPATCHMODE	NUMBER(2,0)		Dispatch mode for fast start plant (0 to 4).
AGCSTATUS	NUMBER(2,0)		AGC Status from EMS * 1 = on * 0 = off
INITIALMW	NUMBER(15,5)		Initial MW at start of period
TOTALCleared	NUMBER(15,5)		Target MW for end of period
RAMPDOWNRATE	NUMBER(15,5)		Ramp down rate used in dispatch (lesser of bid or telemetered rate).
RAMPUPRATE	NUMBER(15,5)		Ramp up rate (lesser of bid or telemetered rate).
LOWER5MIN	NUMBER(15,5)		Lower 5 min reserve target
LOWER60SEC	NUMBER(15,5)		Lower 60 sec reserve target
LOWER6SEC	NUMBER(15,5)		Lower 6 sec reserve target
RAISE5MIN	NUMBER(15,5)		Raise 5 min reserve target
RAISE60SEC	NUMBER(15,5)		Raise 60 sec reserve target

RAISE6SEC	NUMBER(15,5)		Raise 6 sec reserve target
DOWNEPF	NUMBER(15,5)		Not Used
UPEPF	NUMBER(15,5)		Not Used
MARGINAL5MINVALUE	NUMBER(15,5)		Marginal \$ value for 5 min
MARGINAL60SECVALUE	NUMBER(15,5)		Marginal \$ value for 60 seconds
MARGINAL6SECVALUE	NUMBER(15,5)		Marginal \$ value for 6 seconds
MARGINALVALUE	NUMBER(15,5)		Marginal \$ value for energy
VIOLATION5MINDEGREE	NUMBER(15,5)		Violation MW 5 min
VIOLATION60SECDEGREE	NUMBER(15,5)		Violation MW 60 seconds
VIOLATION6SECDEGREE	NUMBER(15,5)		Violation MW 6 seconds
VIOLATIONDEGREE	NUMBER(15,5)		Violation MW energy
LASTCHANGED	DATE		Last date and time record changed
LOWERREG	NUMBER(15,5)		Lower Regulation reserve target
RAISEREG	NUMBER(15,5)		Raise Regulation reserve target
AVAILABILITY	NUMBER(15,5)		Bid energy availability
RAISE6SECFLAGS	NUMBER(3,0)		Raise 6sec status flag - see
RAISE60SECFLAGS	NUMBER(3,0)		Raise 60sec status flag - see
RAISE5MINFLAGS	NUMBER(3,0)		
RAISEREGFLAGS	NUMBER(3,0)		Raise Reg status flag - see
LOWER6SECFLAGS	NUMBER(3,0)		Lower 6sec status flag - see
LOWER60SECFLAGS	NUMBER(3,0)		Lower 60sec status flag
LOWER5MINFLAGS	NUMBER(3,0)		Lower 5min status flag

LOWERREGFLAGS	NUMBER(3,0)		Lower Reg status flag - see
RAISEREGAVAILABILITY	NUMBER(15,5)		RaiseReg availability - minimum of bid and telemetered value
RAISEREGENABLEMENTMAX	NUMBER(15,5)		RaiseReg enablement max point - minimum of bid and telemetered value
RAISEREGENABLEMENTMIN	NUMBER(15,5)		RaiseReg Enablement Min point - maximum of bid and telemetered value
LOWERREGAVAILABILITY	NUMBER(15,5)		Lower Reg availability - minimum of bid and telemetered value
LOWERREGENABLEMENTMAX	NUMBER(15,5)		Lower Reg enablement Max point - minimum of bid and telemetered value
LOWERREGENABLEMENTMIN	NUMBER(15,5)		Lower Reg Enablement Min point - maximum of bid and telemetered value
RAISE6SECACTUALAVAILABILITY	NUMBER(16,6)		trapezium adjusted raise 6sec availability
RAISE60SECACTUALAVAILABILITY	NUMBER(16,6)		trapezium adjusted raise 60sec availability
RAISE5MINACTUALAVAILABILITY	NUMBER(16,6)		trapezium adjusted raise 5min availability
RAISEREGACTUALAVAILABILITY	NUMBER(16,6)		trapezium adjusted raise reg availability
LOWER6SECACTUALAVAILABILITY	NUMBER(16,6)		trapezium adjusted lower 6sec availability
LOWER60SECACTUALAVAILABILITY	NUMBER(16,6)		trapezium adjusted lower 60sec availability

LOWER5MINACTUALAVAILABILITY	NUMBER(16,6)		trapezium adjusted lower 5min availability
LOWERREGACTUALAVAILABILITY	NUMBER(16,6)		trapezium adjusted lower reg availability
SEMIDISPATCHCAP	NUMBER(3,0)		Boolean representation flagging if the Target is Capped

11.18 Table: DISPATCHOFFERTRK

11.18.1 DISPATCHOFFERTRK

Name	DISPATCHOFFERTRK
Comment	DISPATCHOFFERTRK is the energy and ancillary service bid tracking table for the Dispatch process. The table identifies which bids from BIDDAYOFFER and BIDPEROFFER were applied for a given unit and bid type for each dispatch interval.

11.18.2 Description

DISPATCHOFFERTRK data is confidential to each participant until the next trading day, when the data is public to all participants.

Source

DISPATCHOFFERTRK updates every 5 minutes.

Volume

Approximately 250,000 records per day.

11.18.3 Notes

Name	Comment	Value
Visibility	Data in this table is:	Private; Public Next-Day

11.18.4 Primary Key Columns

- Name
- BIDTYPE
- DUID
- SETTLEMENTDATE

11.18.5 Index Columns

Name

LASTCHANGED

11.18.6 Index Columns

Name

DUID

LASTCHANGED

11.18.7 Content

Name	Data Type	Mandatory	Comment
SETTLEMENTDATE	DATE	X	Date and time of the dispatch interval (e.g. five minute dispatch interval ending 28/09/2000 16:35)
DUID	VARCHAR2(10)	X	Dispatchable unit identifier
BIDTYPE	VARCHAR2(10)	X	Bid type Identifier - the ancillary service to which the bid applies
BIDSETTLEMENTDATE	DATE		Settlement date of bid applied
BIDOFFERDATE	DATE		Offer date of bid applied
LASTCHANGED	DATE		Last date and time record changed

11.19 Table: DISPATCHPRICE

11.19.1 DISPATCHPRICE

Name	DISPATCHPRICE
Comment	DISPATCHPRICE records 5 minute dispatch prices for energy and FCAS, including whether an intervention has occurred, or price override (e.g. for Administered Price Cap). DISPATCHPRICE updates when price adjustments occur, in which case the new price is written to the RRP field, and the old price to the ROP field as an audit trail.

11.19.2 Description

Source

DISPATCHPRICE updates every 5 minutes.

Note

APCFLAG is a 5-bit Region-based field indicating that the original Dispatch Price (ROP) calculated by the Dispatch Algorithm for a region has undergone modification by one of more of the following processes:

Bit	Value	Description
5	16	Price Scaling via Inter-regional Loss Factor (IRLF)
4	8	Price manually overwritten
3	4	MPC or MPF binding (ROP was outside of MPC/MPF)
2	2	VoLL Override applied
1	1	APC or APF binding (ROP was outside of APC/APF)

Where:

- MPC = Market Price Cap
- MPF = Market Price Floor
- APC = Administered Price Cap
- APF = Administered Price Floor

xxxAPCFLAGS are each a 5-bit Region-based field indicating FCAS price post-processing (where "ROP" is the original NEMDE Solver price):

Bit	Cum Value	Description
5	16	Not applicable
4	8	Price manually overwritten
3	4	MPC (\$VoLL) or MPF (\$zero) binding (xxFCAS ROP was outside of MPC/MPF)
2	2	Not applicable
1	1	APC or APF binding (ROP was outside of APC/APF)

11.19.3 Notes

Name	Comment	Value
Visibility	Data in this table is:	Public

11.19.4 Primary Key Columns

Name

DISPATCHINTERVAL

INTERVENTION

REGIONID

RUNNO

SETTLEMENTDATE

11.19.5 Index Columns

Name

LASTCHANGED

11.19.6 Content

Name	Data Type	Mandatory	Comment
SETTLEMENTDATE	DATE	X	Market date and time starting at 04:05
RUNNO	NUMBER(3,0)	X	Dispatch run no; always 1
REGIONID	VARCHAR2(10)	X	Region Identifier
DISPATCHINTERVAL	VARCHAR2(22)	X	Dispatch interval identifier 001 to

)		288 in format YYYYMMDDPPP
INTERVENTION	NUMBER(2,0)	X	Manual intervention flag
RRP	NUMBER(15,5)		Regional Reference Price for this dispatch period. RRP is the price used to settle the market
EEP	NUMBER(15,5)		Excess energy price - no longer used
ROP	NUMBER(15,5)		Regional Override Price, being the original price prior to any price scaling, price capping or VoLL override being applied. The APC flag allows the determination of whether capping, scaling or override occurred
APCFLAG	NUMBER(3,0)		APC Active flag (see note)
MARKETSUSPENDEDFLAG	NUMBER(3,0)		Market suspended flag
LASTCHANGED	DATE		Last date and time record changed
RAISE6SECRRP	NUMBER(15,5)		
RAISE6SECROP	NUMBER(15,5)		
RAISE6SECAPCFLAG	NUMBER(3,0)		
RAISE60SECRRP	NUMBER(15,5)		
RAISE60SECROP	NUMBER(15,5)		
RAISE60SECAPCFLAG	NUMBER(3,0)		
RAISE5MINRRP	NUMBER(15,5)		
RAISE5MINROP	NUMBER(15,5)		
RAISE5MINAPCFLAG	NUMBER(3,0)		

RAISEREGRRP	NUMBER(15,5)		
RAISEREGROP	NUMBER(15,5)		
RAISEREGAPCFLAG	NUMBER(3,0)		
LOWER6SECRRP	NUMBER(15,5)		
LOWER6SECROP	NUMBER(15,5)		
LOWER6SECAPCFLAG	NUMBER(3,0)		
LOWER60SECRRP	NUMBER(15,5)		
LOWER60SECROP	NUMBER(15,5)		
LOWER60SECAPCFLAG	NUMBER(3,0)		
LOWER5MINRRP	NUMBER(15,5)		
LOWER5MINROP	NUMBER(15,5)		
LOWER5MINAPCFLAG	NUMBER(3,0)		
LOWERREGRRP	NUMBER(15,5)		
LOWERREGROP	NUMBER(15,5)		
LOWERREGAPCFLAG	NUMBER(3,0)		
PRICE_STATUS	VARCHAR2(20)		Status of regional prices for this dispatch interval "NOT FIRM" or "FIRM"
PRE_AP_ENERGY_PRICE	NUMBER(15,5)		Price before ap capping or scaling - for rolling sum price monitoring
PRE_AP_RAISE6_PRICE	NUMBER(15,5)		Price before ap capping or scaling - for rolling sum price monitoring
PRE_AP_RAISE60_PRICE	NUMBER(15,5)		Price before ap capping or scaling - for rolling sum price monitoring

PRE_AP_RAISE5MIN_PRICE	NUMBER(15,5)		Price before ap capping or scaling - for rolling sum price monitoring
PRE_AP_RAISEREG_PRICE	NUMBER(15,5)		Price before ap capping or scaling - for rolling sum price monitoring
PRE_AP_LOWER6_PRICE	NUMBER(15,5)		Price before ap capping or scaling - for rolling sum price monitoring
PRE_AP_LOWER60_PRICE	NUMBER(15,5)		Price before ap capping or scaling - for rolling sum price monitoring
PRE_AP_LOWER5MIN_PRICE	NUMBER(15,5)		Price before ap capping or scaling - for rolling sum price monitoring
PRE_AP_LOWERREG_PRICE	NUMBER(15,5)		Price before ap capping or scaling - for rolling sum price monitoring
CUMUL_PRE_AP_ENERGY_PRICE	NUMBER(15,5)		Cumulative price that triggers administered pricing event if above the threshold
CUMUL_PRE_AP_RAISE6_PRICE	NUMBER(15,5)		Cumulative price that triggers administered pricing event if above the threshold
CUMUL_PRE_AP_RAISE60_PRICE	NUMBER(15,5)		Cumulative price that triggers administered pricing event if above the threshold
CUMUL_PRE_AP_RAISE5MIN_PRICE	NUMBER(15,5)		Cumulative price that triggers administered pricing event if above the threshold
CUMUL_PRE_AP_RAISEREG_PRICE	NUMBER(15,5)		Cumulative price that triggers administered pricing event if above the threshold
CUMUL_PRE_AP_LOWER6_PRICE	NUMBER(15,5)		Cumulative price that triggers administered pricing event if above the threshold

CUMUL_PRE_AP_LOWER60_PRICE	NUMBER(15,5)		Cumulative price that triggers administered pricing event if above the threshold
CUMUL_PRE_AP_LOWER5_MIN_PRICE	NUMBER(15,5)		Cumulative price that triggers administered pricing event if above the threshold
CUMUL_PRE_AP_LOWERREG_PRICE	NUMBER(15,5)		Cumulative price that triggers administered pricing event if above the threshold
OCD_STATUS	VARCHAR2(14)		Communicates the current OCD status for this dispatch interval. Values of: 'NOT_OCD', 'OCD_UNRESOLVED', 'OCD_RESOLVED'.
MII_STATUS	VARCHAR2(21)		Communicates the current MII status for this dispatch interval. Values of: 'NOT_MII', 'MII_SUBJECT_TO_REVIEW', 'MII_PRICE_REJECTED', 'MII_PRICE_ACCEPTED'.

11.20 Table: DISPATCHREGIONSUM

11.20.1 DISPATCHREGIONSUM

Name	DISPATCHREGIONSUM
Comment	DISPATCHREGIONSUM sets out the 5-minute solution for each dispatch run for each region, including the Frequency Control Ancillary Services (FCAS) services provided. Additional fields are for the Raise Regulation and Lower Regulation Ancillary Services plus improvements to demand calculations.

11.20.2 Description

DISPATCHREGIONSUM is public data, and is available to all participants.

Source

DISPATCHREGIONSUM updates every 5 minutes.

Note

For details of calculations about load calculations, refer to Chapter 3 of the "Statement of Opportunities"

*** "Actual FCAS availability" is determined in a post-processing step based on the energy target (TotalCleared) and bid FCAS trapezium for that interval. However, if the unit is outside the bid FCAS trapezium at the start of the interval (InitialMW), the "Actual FCAS availability" is set to zero. For regulation services, the trapezium is the most restrictive of the bid/SCADA trapezium values.

From 16 February 2006, the old reserve values are no longer populated (i.e. are null), being LORSurplus and LRCSurplus. For more details on the changes to Reporting of Reserve Condition Data, refer to AEMO Communication 2042. For the best available indicator of reserve condition in each of the regions of the NEM for each trading interval, refer to the latest run of the Pre-Dispatch PASA (see table PDPASA_REGIONSOLUTION).

11.20.3 Notes

Name	Comment	Value
Visibility	Data in this table is:	Public

11.20.4 Primary Key Columns

Name	DISPATCHINTERVAL
------	------------------

INTERVENTION

REGIONID

RUNNO

SETTLEMENTDATE

11.20.5 Index Columns

Name

LASTCHANGED

11.20.6 Content

Name	Data Type	Mandatory	Comment
SETTLEMENTDATE	DATE	X	Market date and time starting at 04:05
RUNNO	NUMBER(3,0)	X	Dispatch run no; always 1
REGIONID	VARCHAR2(10)	X	Region Identifier
DISPATCHINTERVAL	NUMBER(22,0)	X	Dispatch period identifier, from 001 to 288 in format YYYYMMDDPPP.
INTERVENTION	NUMBER(2,0)	X	Manual Intervention flag
TOTALDEMAND	NUMBER(15,5)		Demand (less loads)
AVAILABLEGENERATION	NUMBER(15,5)		Aggregate generation bid available in region
AVAILABLELOAD	NUMBER(15,5)		Aggregate load bid available in region

DEMANDFORECAST	NUMBER(15,5)		5 minute forecast adjust
DISPATCHABLEGENERATION	NUMBER(15,5)		Dispatched Generation
DISPATCHABLELOAD	NUMBER(15,5)		Dispatched Load (add to total demand to get inherent region demand).
NETINTERCHANGE	NUMBER(15,5)		Net interconnector flow from the regional reference node
EXCESSGENERATION	NUMBER(15,5)		MW quantity of excess
LOWER5MINDISPATCH	NUMBER(15,5)		Not used since Dec 2003. Lower 5 min MW dispatch
LOWER5MINIMPORT	NUMBER(15,5)		Not used since Dec 2003. Lower 5 min MW imported
LOWER5MINLOCALDISPATCH	NUMBER(15,5)		Lower 5 min local dispatch
LOWER5MINLOCALPRICE	NUMBER(15,5)		Not used since Dec 2003. Local price of lower 5 min
LOWER5MINLOCALREQ	NUMBER(15,5)		Not used since Dec 2003. Lower 5 min local requirement
LOWER5MINPRICE	NUMBER(15,5)		Not used since Dec 2003. Regional price of lower 5 min
LOWER5MINREQ	NUMBER(15,5)		Not used since Dec 2003. Lower 5 min total requirement
LOWER5MINSUPPLYPRICE	NUMBER(15,5)		Not used since Dec 2003. Supply price of lower 5 min
LOWER60SECDISPATCH	NUMBER(15,5)		Not used since Dec 2003. Lower 60 sec MW dispatch
LOWER60SECIMPORT	NUMBER(15,5)		Not used since Dec 2003. Lower 60

			sec MW imported
LOWER60SECLOCALDISPATCH	NUMBER(15,5)		Lower 60 sec local dispatch
LOWER60SECLOCALPRICE	NUMBER(15,5)		Not used since Dec 2003. Local price of lower 60 sec
LOWER60SECLOCALREQ	NUMBER(15,5)		Not used since Dec 2003. Lower 60 sec local requirement
LOWER60SECPRICE	NUMBER(15,5)		Not used since Dec 2003. Regional price of lower 60 sec
LOWER60SECREQ	NUMBER(15,5)		Not used since Dec 2003. Lower 60 sec total requirement
LOWER60SECSUPPLYPRICE	NUMBER(15,5)		Not used since Dec 2003. Supply price of lower 60 sec
LOWER6SECDISPATCH	NUMBER(15,5)		Not used since Dec 2003. Lower 6 sec MW dispatch
LOWER6SECIMPORT	NUMBER(15,5)		Not used since Dec 2003. Lower 6 sec MW imported
LOWER6SECLOCALDISPATCH	NUMBER(15,5)		Lower 6 sec local dispatch
LOWER6SECLOCALPRICE	NUMBER(15,5)		Not used since Dec 2003. Local price of lower 6 sec
LOWER6SECLOCALREQ	NUMBER(15,5)		Not used since Dec 2003. Lower 6 sec local requirement
LOWER6SECPRICE	NUMBER(15,5)		Not used since Dec 2003. Regional price of lower 6 sec
LOWER6SECREQ	NUMBER(15,5)		Not used since Dec 2003. Lower 6 sec total requirement
LOWER6SECSUPPLYPRICE	NUMBER(15,5)		Not used since Dec 2003. Supply price of lower 6 sec

RAISE5MINDISPATCH	NUMBER(15,5)		Not used since Dec 2003. Raise 5 min MW dispatch
RAISE5MINIMPORT	NUMBER(15,5)		Not used since Dec 2003. Raise 5 min MW imported
RAISE5MINLOCALDISPATCH	NUMBER(15,5)		Raise 5 min local dispatch
RAISE5MINLOCALPRICE	NUMBER(15,5)		Not used since Dec 2003. Raise price of lower 5 min
RAISE5MINLOCALREQ	NUMBER(15,5)		Not used since Dec 2003. Raise 5 min local requirement
RAISE5MINPRICE	NUMBER(15,5)		Not used since Dec 2003. Regional price of raise 5 min
RAISE5MINREQ	NUMBER(15,5)		Not used since Dec 2003. Raise 5 min total requirement
RAISE5MINSUPPLYPRICE	NUMBER(15,5)		Not used since Dec 2003. Supply price of raise 5 min
RAISE60SECDISPATCH	NUMBER(15,5)		Not used since Dec 2003. Raise 60 sec MW dispatch
RAISE60SECIMPORT	NUMBER(15,5)		Not used since Dec 2003. Raise 60 sec MW imported
RAISE60SECLOCALDISPATCH	NUMBER(15,5)		Raise 60 sec local dispatch
RAISE60SECLOCALPRICE	NUMBER(15,5)		Not used since Dec 2003. Local price of raise 60 sec
RAISE60SECLOCALREQ	NUMBER(15,5)		Not used since Dec 2003. Raise 60 sec local requirement
RAISE60SECPRICE	NUMBER(15,5)		Not used since Dec 2003. Regional price of raise 60 sec

RAISE60SECREQ	NUMBER(15,5)		Not used since Dec 2003. Raise 60 sec total requirement
RAISE60SECSUPPLYPRICE	NUMBER(15,5)		Not used since Dec 2003. Supply price of raise 60 sec
RAISE6SECDISPATCH	NUMBER(15,5)		Not used since Dec 2003. Raise 6 sec MW dispatch
RAISE6SECIMPORT	NUMBER(15,5)		Not used since Dec 2003. Raise 6 sec MW imported
RAISE6SECLOCALDISPATCH	NUMBER(15,5)		Raise 6 sec local dispatch
RAISE6SECLOCALPRICE	NUMBER(15,5)		Not used since Dec 2003. Local price of raise 6 sec
RAISE6SECLOCALREQ	NUMBER(15,5)		Not used since Dec 2003. Raise 6 sec local requirement
RAISE6SECPRICE	NUMBER(15,5)		Not used since Dec 2003. Regional price of raise 6 sec
RAISE6SECREQ	NUMBER(15,5)		Not used since Dec 2003. Raise 6 sec total requirement
RAISE6SECSUPPLYPRICE	NUMBER(15,5)		Not used since Dec 2003. Supply price of raise 6 sec
AGGEGATEDISPATCHERROR	NUMBER(15,5)		Calculated dispatch error
AGGREGATEDISPATCHERROR	NUMBER(15,5)		Calculated dispatch error
LASTCHANGED	DATE		Last date and time record changed
INITIALSUPPLY	NUMBER(15,5)		Sum of initial generation and import for region
CLEAREDSUPPLY	NUMBER(15,5)		Sum of cleared generation and

			import for region
LOWERREGIMPORT	NUMBER(15,5)		Not used since Dec 2003. Lower Regulation MW imported
LOWERREGLOCALDISPATCH	NUMBER(15,5)		Lower Regulation local dispatch
LOWERREGLOCALREQ	NUMBER(15,5)		Not used since Dec 2003. Lower Regulation local requirement
LOWERREGREQ	NUMBER(15,5)		Not used since Dec 2003. Lower Regulation total requirement
RAISEREGIMPORT	NUMBER(15,5)		Not used since Dec 2003. Raise Regulation MW imported
RAISEREGLOCALDISPATCH	NUMBER(15,5)		Raise Regulation local dispatch
RAISEREGLOCALREQ	NUMBER(15,5)		Not used since Dec 2003. Raise Regulation local requirement
RAISEREGREQ	NUMBER(15,5)		Not used since Dec 2003. Raise Regulation total requirement
RAISE5MINLOCALVIOLATION	NUMBER(15,5)		Not used since Dec 2003. Violation (MW) of Raise 5 min local requirement
RAISEREGLOCALVIOLATION	NUMBER(15,5)		Not used since Dec 2003. Violation (MW) of Raise Reg local requirement
RAISE60SECLOCALVIOLATION	NUMBER(15,5)		Not used since Dec 2003. Violation (MW) of Raise 60 sec local requirement
RAISE6SECLOCALVIOLATION	NUMBER(15,5)		Not used since Dec 2003. Violation (MW) of Raise 6 sec local requirement
LOWER5MINLOCALVIOLATION	NUMBER(15,5)		Not used since Dec 2003. Violation (MW) of Lower 5 min local

ION			requirement
LOWERREGLOCALVIOLATION	NUMBER(15,5)		Not used since Dec 2003. Violation (MW) of Lower Reg local requirement
LOWER60SECLOCALVIOLATION	NUMBER(15,5)		Not used since Dec 2003. Violation (MW) of Lower 60 sec local requirement
LOWER6SECLOCALVIOLATION	NUMBER(15,5)		Not used since Dec 2003. Violation (MW) of Lower 6 sec local requirement
RAISE5MINVIOLATION	NUMBER(15,5)		Not used since Dec 2003. Violation (MW) of Raise 5 min requirement
RAISEREGVIOLATION	NUMBER(15,5)		Not used since Dec 2003. Violation (MW) of Raise Reg requirement
RAISE60SECVIOLATION	NUMBER(15,5)		Not used since Dec 2003. Violation (MW) of Raise 60 seconds requirement
RAISE6SECVIOLATION	NUMBER(15,5)		Not used since Dec 2003. Violation (MW) of Raise 6 seconds requirement
LOWER5MINVIOLATION	NUMBER(15,5)		Not used since Dec 2003. Violation (MW) of Lower 5 min requirement
LOWERREGVIOLATION	NUMBER(15,5)		Not used since Dec 2003. Violation (MW) of Lower Reg requirement
LOWER60SECVIOLATION	NUMBER(15,5)		Not used since Dec 2003. Violation (MW) of Lower 60 seconds requirement
LOWER6SECVIOLATION	NUMBER(15,5)		Not used since Dec 2003. Violation (MW) of Lower 6 seconds requirement

RAISE6SECACTUALAVAILABILITY	NUMBER(16,6)		trapezium adjusted raise 6sec availability
RAISE60SECACTUALAVAILABILITY	NUMBER(16,6)		trapezium adjusted raise 60sec availability
RAISE5MINACTUALAVAILABILITY	NUMBER(16,6)		trapezium adjusted raise 5min availability
RAISEREGACTUALAVAILABILITY	NUMBER(16,6)		trapezium adjusted raise reg availability
LOWER6SECACTUALAVAILABILITY	NUMBER(16,6)		trapezium adjusted lower 6sec availability
LOWER60SECACTUALAVAILABILITY	NUMBER(16,6)		trapezium adjusted lower 60sec availability
LOWER5MINACTUALAVAILABILITY	NUMBER(16,6)		trapezium adjusted lower 5min availability
LOWERREGACTUALAVAILABILITY	NUMBER(16,6)		trapezium adjusted lower reg availability
LORSURPLUS	NUMBER(16,6)		Not in use after 17 Feb 2006. Total short term generation capacity reserve used in assessing lack of reserve condition
LRCSURPLUS	NUMBER(16,6)		Not in use after 17 Feb 2006. Total short term generation capacity reserve above the stated low reserve condition requirement
TOTALINTERMITTENTGENERATION	NUMBER(15,5)		Allowance made for non-scheduled generation in the demand forecast (MW).
DEMAND_AND_NONSCHEDEGEN	NUMBER(15,5)		Sum of Cleared Scheduled generation, imported generation (at the region boundary) and allowances made for non-

			scheduled generation (MW).
UIGF	NUMBER(15,5)		Regional aggregated Unconstrained Intermittent Generation Forecast of Semi-scheduled generation (MW).
SEMISCHEDULE_CLEARED MW	NUMBER(15,5)		Regional aggregated Semi-Schedule generator Cleared MW
SEMISCHEDULE_COMPLIANCE MW	NUMBER(15,5)		Regional aggregated Semi-Schedule generator Cleared MW where Semi-Dispatch cap is enforced
SS_SOLAR_UIGF	Number(15,5)		Regional aggregated Unconstrained Intermittent Generation Forecast of Semi-scheduled generation (MW) where the primary fuel source is solar
SS_WIND_UIGF	Number (15,5)		Regional aggregated Unconstrained Intermittent Generation Forecast of Semi-scheduled generation (MW) where the primary fuel source is wind
SS_SOLAR_CLEAREDMW	Number(15,5)		Regional aggregated Semi-Schedule generator Cleared MW where the primary fuel source is solar
SS_WIND_CLEAREDMW	Number(15,5)		Regional aggregated Semi-Schedule generator Cleared MW where the primary fuel source is wind
SS_SOLAR_COMPLIANCE MW	Number(15,5)		Regional aggregated Semi-Schedule generator Cleared MW where Semi-Dispatch cap is enforced and the primary fuel

			source is solar
SS_WIND_COMPLIANCEM W	Number(15,5)		Regional aggregated Semi-Schedule generator Cleared MW where Semi-Dispatch cap is enforced and the primary fuel source is wind

11.21 Table: INTERMITTENT_FORECAST_TRK

11.21.1 INTERMITTENT_FORECAST_TRK

Name INTERMITTENT_FORECAST_TRK

Comment Uniquely tracks which Intermittent Generation forecast was used for the DUID in which Dispatch run

11.21.2 Notes

Name	Comment	Value
Visibility	Data in this table is:	Public

11.21.3 Primary Key Columns

Name

DUID

SETTLEMENTDATE

11.21.4 Content

Name	Data Type	Mandatory	Comment
SETTLEMENTDATE	DATE	X	Date/Time of the Dispatch run (dispatch interval ending)
DUID	VARCHAR2(20)	X	Tracks to INTERMITTENT_DS_RUN.DUID
ORIGIN	VARCHAR2(20)		Tracks to INTERMITTENT_DS_RUN.ORIGIN, SCADA is written to ORIGIN if no forecast is discovered.

FORECAST_PRIORITY	NUMBER(10,0)		Tracks to INTERMITTENT_DS_RUN.FORECAST_PRIORITY - except for -1 and 0, which denote "Last Target" and "SCADA" respectively
OFFERDATETIME	DATE		Tracks to INTERMITTENT_DS_RUN.OFFERDATETIME

11.22 Table: NEGATIVE_RESIDUE

11.22.1 NEGATIVE_RESIDUE

Name NEGATIVE_RESIDUE

Comment Shows the inputs provided to the Negative Residue Constraints in the Dispatch horizon

11.22.2 Notes

Name	Comment	Value
Visibility	Data in this table is:	Public

11.22.3 Primary Key Columns

Name

DIRECTIONAL_INTERCONNECTORID

NRM_DATETIME

SETTLEMENTDATE

11.22.4 Index Columns

Name

SETTLEMENTDATE

NRM_DATETIME

DIRECTIONAL_INTERCONNECTORID

11.22.5 Content

Name	Data Type	Manda	Comment
------	-----------	-------	---------

		tory	
SETTLEMENTDATE	date	X	Dispatch Interval
NRM_DATETIME	date	X	The time that residue information is processed
DIRECTIONAL_INTERCONNECTORID	varchar2(30)	X	Negative residue related direction interconnector id
NRM_ACTIVATED_FLAG	number(1,0)		Is 1 if negative residue process is on, else is 0
CUMUL_NEGRESIDUE_AMOUNT	number(15,5)		Negative residue triggering amount
CUMUL_NEGRESIDUE_PREV_TI	number(15,5)		Previous trading interval cumulative negative residue amount
NEGRESIDUE_CURRENT_TI	number(15,5)		Current trading interval negative residue amount
NEGRESIDUE_PD_NEXT_TI	number(15,5)		The cumulative negative residue for the next trading interval (PD)
PRICE_REVISION	varchar2(30)		SubjectToReview, Indeterminate, Accepted or Rejected
PREDISPATCHSEQNO	varchar2(20)		Predispatch sequence number
EVENT_ACTIVATED_DI	date		The starting DI when NRM event is active
EVENT_DEACTIVATED_DI	date		The finishing DI when NRM event stops being active.
DI_NOTBINDING_COUNT	number(2,0)		Count of the number of DIs not binding by this constraint
DI_VIOLATED_COUNT	number(2,0)		Count of the number of DIs violated by this constraint

NRMCONSTRAINT_BLOCK ED_FLAG	number(1,0)		1 if constraint is blocked, else 0
--------------------------------	-------------	--	------------------------------------

12 Package: FORCE_MAJEURE

<i>Name</i>	FORCE_MAJEURE
<i>Comment</i>	Market Suspensions and administer pricing event data

12.1 List of tables

Name	Comment
APEVENT	APEVENT is the driving data defining the existence and timeframes of an administered pricing event.
APEVENTREGION	APEVENTREGION is the Region detail for an administered pricing event defined through APEVENT.
IRFMAMOUNT	IRFMAMOUNT sets out settlement amounts associated with Industrial Relations Forced Majeure events.
IRFMEVENTS	IRFMEVENTS sets out specific Industrial Relations Forced Majeure events.
MARKET_SUSPEND_REGIME_SUM	Tracks the evolution of pricing regimes applied to the suspended region and from which Dispatch Interval
MARKET_SUSPEND_REGION_SUM	Summary of Market Suspension timings
MARKET_SUSPEND_SCHEDULE	Trading prices that will apply in the event of a market suspension event updated weekly.
MARKET_SUSPEND_SCHEDULE_TRK	Parent table for pricing regimes used in suspensions
OVERRIDERRP	OVERRIDERRP shows details of override price periods.
REGIONAPC	REGIONAPC defines Administered Price profiles (Energy and FCAS) for a region.
REGIONAPCINTERVALS	REGIONAPCINTERVALS contains Administered Price

	profiles (Energy and FCAS) applicable to each interval for a region.
--	--

12.2 Diagram: Entities: Force Majeure

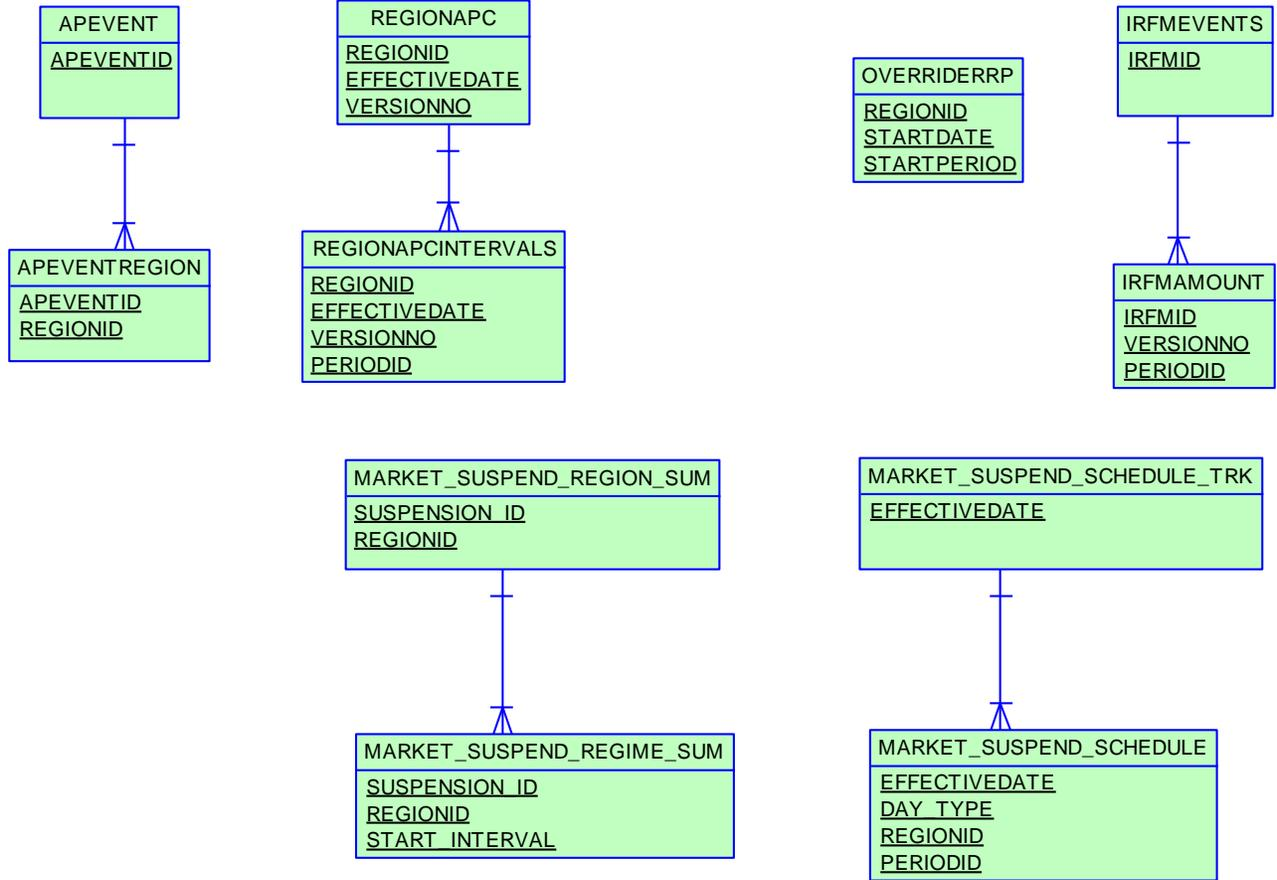

12.3 Table: APEVENT

12.3.1 APEVENT

Name	APEVENT
Comment	APEVENT is the driving data defining the existence and timeframes of an administered pricing event.

12.3.2 Notes

Name	Comment	Value
Visibility	Data in this table is:	Public

12.3.3 Primary Key Columns

Name
APEVENTID

12.3.4 Index Columns

Name
LASTCHANGED

12.3.5 Content

Name	Data Type	Mandatory	Comment
APEVENTID	NUMBER(22,0)	X	Unique identifier for this administered pricing event
EFFECTIVEFROMINTERVAL	DATE		Date Time of the first Dispatch Interval to which the administered

			event applies
EFFECTIVETOINTERVAL	DATE		Date Time of the final Dispatch Interval to which the administered event applies
REASON	VARCHAR2(2000)		Description of the driver for the Event
STARTAUTHORISED	DATE		Date-Time start authorised
STARTAUTHORISED	DATE		Date-Time start authorised
STARTAUTHORISEDBY	VARCHAR2(15)		Authorising staff for start of AP event
STARTAUTHORISEDDATE	DATE		Date-Time start authorised
ENDAUTHORISEDBY	VARCHAR2(15)		Authorising staff for end of AP event
ENDAUTHORISEDDATE	DATE		Date Time end authorised
ENDAUTHORISEDDATE	DATE		Date Time end authorised
LASTCHANGED	DATE		Date-Time the record was last modified

12.4 Table: APEVENTREGION

12.4.1 APEVENTREGION

Name APEVENTREGION

Comment APEVENTREGION is the Region detail for an administered pricing event defined through APEVENT.

12.4.2 Notes

Name	Comment	Value
Visibility	Data in this table is:	Public

12.4.3 Primary Key Columns

Name

APEVENTID

REGIONID

12.4.4 Index Columns

Name

LASTCHANGED

12.4.5 Content

Name	Data Type	Mandatory	Comment
APEVENTID	NUMBER(22,0)	X	Unique identifier for this administered pricing event
REGIONID	VARCHAR2(10)	X	Date-Time of the first Dispatch

)		Interval to which the administered event applies
LASTCHANGED	DATE		Date Time of the final Dispatch Interval to which the administered event applies
ENERGYAPFLAG	NUMBER(1,0)		flag indicating if the apevent covers an energy AP
RAISE6SECAPFLAG	NUMBER(1,0)		flag indicating if the apevent covers a raise6sec AP
RAISE60SECAPFLAG	NUMBER(1,0)		flag indicating if the apevent covers a raise60sec AP
RAISE5MINAPFLAG	NUMBER(1,0)		flag indicating if the apevent covers a raise5min AP
RAISEREGAPFLAG	NUMBER(1,0)		flag indicating if the apevent covers a raisereg AP
LOWER6SECAPFLAG	NUMBER(1,0)		flag indicating if the apevent covers a lower6sec AP
LOWER60SECAPFLAG	NUMBER(1,0)		flag indicating if the apevent covers a lower60sec AP flag indicating if the apevent covers a lower5min AP flag indicating if the apevent covers a lowerreg AP flag indicating if the apevent covers a lower60sec AP
LOWER5MINAPFLAG	NUMBER(1,0)		flag indicating if the apevent covers a lower5min AP
LOWERREGAPFLAG	NUMBER(1,0)		flag indicating if the apevent covers a lowerreg AP

12.5 Table: IRFMAMOUNT

12.5.1 IRFMAMOUNT

Name	IRFMAMOUNT
Comment	IRFMAMOUNT sets out settlement amounts associated with Industrial Relations Forced Majeure events.

12.5.2 Description

IRFMAMOUNT is public data.

Source

IRFMAMOUNT is obsolete; was updated with each settlement run as required.

12.5.3 Notes

Name	Comment	Value
Visibility	Data in this table is:	Public

12.5.4 Primary Key Columns

- Name
- IRFMID
- PERIODID
- VERSIONNO

12.5.5 Index Columns

- Name
- LASTCHANGED

12.5.6 Content

Name	Data Type	Mandatory	Comment
IRFMID	VARCHAR2(10)	X	Unique Industrial Relations Force Majeure event
EFFECTIVEDATE	DATE		Date of event
VERSIONNO	NUMBER(3,0)	X	Version number of record of event
PERIODID	NUMBER(4,0)	X	Settlement period
AMOUNT	NUMBER(15,5)		Total settlement amount in \$
AUTHORISED BY	VARCHAR2(15)		Person authorising amount
AUTHORISED DATE	DATE		Authorised date
LASTCHANGED	DATE		last changed

12.6 Table: IRFMEVENTS

12.6.1 IRFMEVENTS

Name	IRFMEVENTS
Comment	IRFMEVENTS sets out specific Industrial Relations Forced Majeure events.

12.6.2 Description

IRFMEVENTS is public data.

Source

IRFMEVENTS updates with the occurrence of any such events.

12.6.3 Notes

Name	Comment	Value
Visibility	Data in this table is:	Public

12.6.4 Primary Key Columns

Name
IRFMID

12.6.5 Index Columns

Name
LASTCHANGED

12.6.6 Content

Name	Data Type	Mandatory	Comment

IRFMID	VARCHAR2(10)	X	
STARTDATE	DATE		
STARTPERIOD	NUMBER(3,0)		
ENDDATE	DATE		
ENDPERIOD	NUMBER(3,0)		
LASTCHANGED	DATE		

12.7 Table: MARKET_SUSPEND_REGIME_SUM

12.7.1 MARKET_SUSPEND_REGIME_SUM

Name	MARKET_SUSPEND_REGIME_SUM
Comment	Tracks the evolution of pricing regimes applied to the suspended region and from which Dispatch Interval

12.7.2 Description

MARKET_SUSPEND_REGIME_SUM is public data, so is available to all participants.

12.7.3 Notes

Name	Comment	Value
Visibility	Data in this table is:	Public

12.7.4 Primary Key Columns

Name
 REGIONID
 START_INTERVAL
 SUSPENSION_ID

12.7.5 Content

Name	Data Type	Mandatory	Comment
SUSPENSION_ID	VARCHAR2(20)	X	Unique identifier for this suspension event
REGIONID	VARCHAR2(20)	X	Region(s) covered by this evolution

)		of the event
START_INTERVAL	DATE	X	First Dispatch interval from which this regime applies
END_INTERVAL	DATE		Last Dispatch interval for which this regime applies
PRICING_REGIME	VARCHAR2(20)		Pricing Regime applied
LASTCHANGED	DATE		Last date and time record changed

12.8 Table: MARKET_SUSPEND_REGION_SUM

12.8.1 MARKET_SUSPEND_REGION_SUM

Name	MARKET_SUSPEND_REGION_SUM
Comment	Summary of Market Suspension timings

12.8.2 Description

MARKET_SUSPEND is public data, so is available to all participants.

12.8.3 Notes

Name	Comment	Value
Visibility	Data in this table is:	Public

12.8.4 Primary Key Columns

Name
 REGIONID
 SUSPENSION_ID

12.8.5 Content

Name	Data Type	Mandatory	Comment
SUSPENSION_ID	VARCHAR2(20)	X	Unique identifier for this suspension event
REGIONID	VARCHAR2(20)	X	Region(s) covered by the Suspension event
INITIAL_INTERVAL	DATE		Initial interval of the Suspension

			event
END_REGION_INTERVAL	DATE		Last Dispatch interval for the Suspension event for this Region
END_SUSPENSION_INTERVAL	DATE		Last Dispatch interval for the Suspension event
LASTCHANGED	DATE		Last DateTime the Suspension was administered

12.9 Table: MARKET_SUSPEND_SCHEDULE

12.9.1 MARKET_SUSPEND_SCHEDULE

Name MARKET_SUSPEND_SCHEDULE

Comment Trading prices that will apply in the event of a market suspension event updated weekly.

12.9.2 Description

MARKET_SUSPEND_SCHEDULE is public data, so is available to all participants.

12.9.3 Notes

Name	Comment	Value
Visibility	Data in this table is:	Public

12.9.4 Primary Key Columns

Name

DAY_TYPE

EFFECTIVEDATE

PERIODID

REGIONID

12.9.5 Content

Name	Data Type	Mandatory	Comment
EFFECTIVEDATE	DATE	X	Calendar date from when this record set is effective

DAY_TYPE	VARCHAR2(20)	X	Distinguishes which record set to apply - at time of writing this was Business or Non-business day but may change in the future depending on outcome of consultation
REGIONID	VARCHAR2(20)	X	Region affected.
PERIODID	NUMBER(3,0)	X	48 intervals for a day, midnight base (equates to 00:30 - 00:00)
ENERGY_RRP	NUMBER(15,5)		Energy Price applied for this period for this Day Type
R6_RRP	NUMBER(15,5)		Raise 6Sec contingency Price applied for this period for this Day Type
R60_RRP	NUMBER(15,5)		Raise 60Sec contingency Price applied for this period for this Day Type
R5_RRP	NUMBER(15,5)		Raise 5Min contingency Price applied for this period for this Day Type
RREG_RRP	NUMBER(15,5)		Raise Regulation contingency Price applied for this period for this Day Type
L6_RRP	NUMBER(15,5)		Lower 6Sec contingency Price applied for this period for this Day Type
L60_RRP	NUMBER(15,5)		Lower 60Sec contingency Price applied for this period for this Day Type
L5_RRP	NUMBER(15,5)		Lower 5Min contingency Price applied for this period for this Day

			Type
LREG_RRP	NUMBER(15,5)		Lower Regulation Price applied for this period for this Day Type
LASTCHANGED	DATE		Last date and time record changed

12.10 Table: MARKET_SUSPEND_SCHEDULE_TRK

12.10.1 MARKET_SUSPEND_SCHEDULE_TRK

Name MARKET_SUSPEND_SCHEDULE_TRK

Comment Parent table for pricing regimes used in suspensions

12.10.2 Notes

Name	Comment	Value
Visibility	Data in this table is:	Public

12.10.3 Primary Key Columns

Name

EFFECTIVEDATE

12.10.4 Content

Name	Data Type	Mandatory	Comment
EFFECTIVEDATE	DATE	X	Calendar date from when this record set is effective
SOURCE_START_DATE	DATE		Start Date of the date range for the source data
SOURCE_END_DATE	DATE		End Date of the date range for the source data
COMMENTS	VARCHAR2(1000)		Reason why this regime was applied
AUTHORISEDDATE	DATE		Date/Time this record set was loaded

LASTCHANGED	DATE		Last date and time record changed
-------------	------	--	-----------------------------------

12.11 Table: OVERRIDERRP

12.11.1 OVERRIDERRP

Name OVERRIDERRP

Comment OVERRIDERRP shows details of override price periods.

12.11.2 Description

OVERRIDERRP data is public, so is available to all participants.

Source

OVERRIDERRP updates every five minutes when override prices apply for the period.

12.11.3 Notes

Name	Comment	Value
Visibility	Data in this table is:	Public

12.11.4 Primary Key Columns

Name

REGIONID

STARTDATE

STARTPERIOD

12.11.5 Index Columns

Name

LASTCHANGED

12.11.6 Content

Name	Data Type	Mandatory	Comment
REGIONID	VARCHAR2(10)	X	Region Identifier
STARTDATE	DATE	X	Starting date of override
STARTPERIOD	NUMBER(3,0)	X	Starting period of override
ENDDATE	DATE		Termination date of override
ENDPERIOD	NUMBER(3,0)		Terminate period of override
RRP	NUMBER(15,0)		Dispatch Price
DESCRIPTION	VARCHAR2(128)		Description of reason for override
AUTHORISESTART	VARCHAR2(15)		Authorise Start of Override
AUTHORISEEND	VARCHAR2(15)		Authorise End of Override
LASTCHANGED	DATE		Last date and time record changed

12.12 Table: REGIONAPC

12.12.1 REGIONAPC

Name	REGIONAPC
Comment	REGIONAPC defines Administered Price profiles (Energy and FCAS) for a region.

12.12.2 Description

REGIONAPC data is public, so is available to all participants.

Source

REGIONAPC updates when a change is ever made to the Administered Price Cap details. Changes to this table are infrequent.

12.12.3 Notes

Name	Comment	Value
Visibility	Data in this table is:	Public

12.12.4 Primary Key Columns

- Name
- EFFECTIVEDATE
- REGIONID
- VERSIONNO

12.12.5 Index Columns

- Name
- LASTCHANGED

12.12.6 Content

Name	Data Type	Mandatory	Comment
REGIONID	VARCHAR2(10)	X	Region Identifier
EFFECTIVEDATE	DATE	X	Date the APC profile applies from
VERSIONNO	NUMBER(3,0)	X	Version number for the same date
AUTHORISEDDATE	DATE		Authorised date
AUTHORISEDBY	VARCHAR2(10)		Authorised by
LASTCHANGED	DATE		Last date and time record changed

12.13 Table: REGIONAPCINTERVALS

12.13.1 REGIONAPCINTERVALS

Name	REGIONAPCINTERVALS
Comment	REGIONAPCINTERVALS contains Administered Price profiles (Energy and FCAS) applicable to each interval for a region.

12.13.2 Description

REGIONAPCINTERVALS data is public, so is available to all participants.

Source

REGIONAPCINTERVALS is updated whenever an Administered Price Cap occurs.

12.13.3 Notes

Name	Comment	Value
Visibility	Data in this table is:	Public

12.13.4 Primary Key Columns

- Name
- EFFECTIVEDATE
- PERIODID
- REGIONID
- VERSIONNO

12.13.5 Index Columns

- Name
- LASTCHANGED

12.13.6 Content

Name	Data Type	Mandatory	Comment
REGIONID	VARCHAR2(10)	X	Region Identifier
EFFECTIVEDATE	DATE	X	Date the APC profile applies from
VERSIONNO	NUMBER(3,0)	X	Version number for the same date
PERIODID	NUMBER(3,0)	X	Period number where 1 is the 00:30 EST
APCVALUE	NUMBER(16,6)		Administered price cap in \$
LASTCHANGED	DATE		Last date and time record changed
APCTYPE	NUMBER(3,0)		not used
FCASAPCVALUE	NUMBER(16,6)		FCAS Administered price cap in \$
APFVALUE	NUMBER(16,6)		Administered price floor in \$

13 Package: GD_INSTRUCT

<i>Name</i>	GD_INSTRUCT
<i>Comment</i>	General Dispatch Instruction data

13.1 List of tables

Name	Comment
GDINSTRUCT	GDINSTRUCT shows all manually issued dispatch instructions for a dispatchable unit. Ancillary Service instructions are to enable and to disable (i.e. 2 separate instructions) a service. Non-conforming units are also instructed via this facility. However, this facility is not the same as the market notice.
INSTRUCTIONSUBTYPE	Each Dispatch instruction (GD instruct) has a type and subtype. INSTRUCTIONSUBTYPE, together with INSTRUCTIONTYPE, sets out valid instruction types.
INSTRUCTIONTYPE	Dispatch instruction (GD instruct) has types and subtypes. INSTRUCTIONTYPE, together with INSTRUCTIONSUBTYPE, sets out valid instruction types.

13.2 Diagram: Entities: GD Instruct

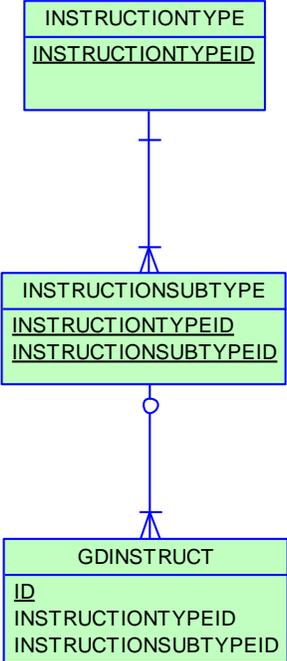

13.3 Table: GDINSTRUCT

13.3.1 GDINSTRUCT

Name	GDINSTRUCT
Comment	GDINSTRUCT shows all manually issued dispatch instructions for a dispatchable unit. Ancillary Service instructions are to enable and to disable (i.e. 2 separate instructions) a service. Non-conforming units are also instructed via this facility. However, this facility is not the same as the market notice.

13.3.2 Description

Source

GDINSTRUCT updates on issue of an instruction by AEMO, with visibility restricted on the day of issue to the relevant participant. All participants have previous days' data available.

13.3.3 Notes

Name	Comment	Value
Visibility	Data in this table is:	Public

13.3.4 Primary Key Columns

- Name
- ID

13.3.5 Index Columns

- Name
- LASTCHANGED

13.3.6 Index Columns

Name

DUID

13.3.7 Index Columns

Name

TARGETTIME

13.3.8 Content

Name	Data Type	Mandatory	Comment
DUID	VARCHAR2(10)		Dispatchable unit identifier
STATIONID	VARCHAR2(10)		Station Identifier
REGIONID	VARCHAR2(10)		Region Identifier
ID	NUMBER(22,0)	X	Instruction ID (sequential number)
INSTRUCTIONTYPEID	VARCHAR2(10)		Instruction type
INSTRUCTIONSUBTYPEID	VARCHAR2(10)		Instruction sub type
INSTRUCTIONCLASSID	VARCHAR2(10)		Instruction class
REASON	VARCHAR2(64)		Reason
INSTLEVEL	NUMBER(6,0)		Instruction target level

AUTHORISEDDATE	DATE		Authorised date
AUTHORISEDBY	VARCHAR2(15)		User authorised by
PARTICIPANTID	VARCHAR2(10)		Unique participant identifier
ISSUEDTIME	DATE		Date / time issued
TARGETTIME	DATE		Date / time instruction to apply
LASTCHANGED	DATE		Last date and time record changed

13.4 Table: INSTRUCTIONSUBTYPE

13.4.1 INSTRUCTIONSUBTYPE

Name	INSTRUCTIONSUBTYPE
Comment	Each Dispatch instruction (GD instruct) has a type and subtype. INSTRUCTIONSUBTYPE, together with INSTRUCTIONTYPE, sets out valid instruction types.

13.4.2 Description

INSTRUCTIONSUBTYPE is public data, and is available to all participants.

Source

INSTRUCTIONSUBTYPE shows ad hoc updates to market configuration.

13.4.3 Notes

Name	Comment	Value
Visibility	Data in this table is:	Public

13.4.4 Primary Key Columns

- Name
- INSTRUCTIONSUBTYPEID
- INSTRUCTIONTYPEID

13.4.5 Index Columns

- Name
- LASTCHANGED

13.4.6 Content

Name	Data Type	Mandatory	Comment
INSTRUCTIONTYPEID	VARCHAR2(10)	X	Instruction type
INSTRUCTIONSUBTYPEID	VARCHAR2(10)	X	Subtype for each dispatch instruction type, for example governor off.
DESCRIPTION	VARCHAR2(64)		Description of instruction subtype
LASTCHANGED	DATE		Last date and time record changed

13.5 Table: INSTRUCTIONTYPE

13.5.1 INSTRUCTIONTYPE

Name	INSTRUCTIONTYPE
Comment	Dispatch instruction (GD instruct) has types and subtypes. INSTRUCTIONTYPE, together with INSTRUCTIONSUBTYPE, sets out valid instruction types.

13.5.2 Description

INSTRUCTIONTYPE data is public to all participants.

Source

INSTRUCTIONTYPE shows ad hoc updates to market configuration.

13.5.3 Notes

Name	Comment	Value
Visibility	Data in this table is:	Public

13.5.4 Primary Key Columns

Name
INSTRUCTIONTYPEID

13.5.5 Index Columns

Name
LASTCHANGED

13.5.6 Content

Name	Data Type	Mandatory	Comment
INSTRUCTIONTYPEID	VARCHAR2(10)	X	Dispatch instruction type for example FCAS service.
DESCRIPTION	VARCHAR2(64)		Description of instruction type
REGIONID	VARCHAR2(10)		Region id if regional instruction only.
LASTCHANGED	DATE		Last date and time record changed

14 Package: **GENERIC_CONSTRAINT**

<i>Name</i>	GENERIC_CONSTRAINT
<i>Comment</i>	Generic Constraint Standing Data and Invocations

14.1 List of tables

Name	Comment
EMSMASTER	EMSMASTER provides a description of the SCADA measurements that are associated with the SPD_ID points utilised in generic equation RHS terms
GENCONDATA	<p>GENCONDATA sets out the generic constraints contained within a generic constraint set invoked in PASA, predispach and dispatch.</p> <p>Fields enable selective application of invoked constraints in the Dispatch, Predispach, ST PASA or MT PASA processes.</p>
GENCONSET	GENCONSET sets out generic constraint sets that are invoked and revoked, and may contain many generic constraints (GENCONDATA).
GENCONSETINVOKE	<p>GENCONSETINVOKE provides details of invoked and revoked generic constraints. GENCONSETINVOKE is the key table for determining what constraints are active in dispatch, predispach and PASA.</p> <p>GENCONSETINVOKE also indicates whether constraints are for interconnector limits, ancillary services, etc.</p>
GENCONSETTRK	GENCONSETTRK assists in determining the correct version of a generic constraint set that has been invoked in GENCONSETINVOKE.

GENERICCONSTRAINTRHS	<p>GENERICCONSTRAINTRHS sets out details of generic constraint Right Hand Side (RHS) formulations for dispatch (DS), predispach (PD) and Short Term PASA (ST). GENERICCONSTRAINTRHS also includes general expressions (EQ) used in the dispatch, predispach and PASA time frames.</p> <p>GENERICCONSTRAINTRHS replaces data previously available via the "Constraint Library" Excel spreadsheet.</p>
GENERICEQUATIONDESC	<p>GENERICEQUATIONDESC defines a generic equation identifier with a description. The formulation of the generic equation is detailed in GENERICEQUATIONRHS.</p>
GENERICEQUATIONRHS	<p>GENERICEQUATIONRHS stores the formulation of commonly used Generic Constraint Right Hand Side Equations referenced from Generic Constraint Right Hand Side definitions stored in GENERICCONSTRAINTRHS. The Generic Equation definitions are versioned and the latest effective version is applied to the dispatch process.</p>
SPDCONNECTIONPOINTCONSTRAINT	<p>SPDCONNECTIONPOINTCONSTRAINT sets out details of connections point constraints issued in dispatch, predispach and STPASA.</p>
SPDINTERCONNECTORCONSTRAINT	<p>SPDINTERCONNECTORCONSTRAINT contains details on the interconnector constraint factors used in dispatch, predispach and STPASA. The details set a LHS value.</p>
SPDREGIONCONSTRAINT	<p>SPDREGIONCONSTRAINT contains details on region demand constraint factors used in dispatch. SPDREGIONCONSTRAINT sets a LHS value.</p>

14.2 Diagram: Entities: Generic Constraints

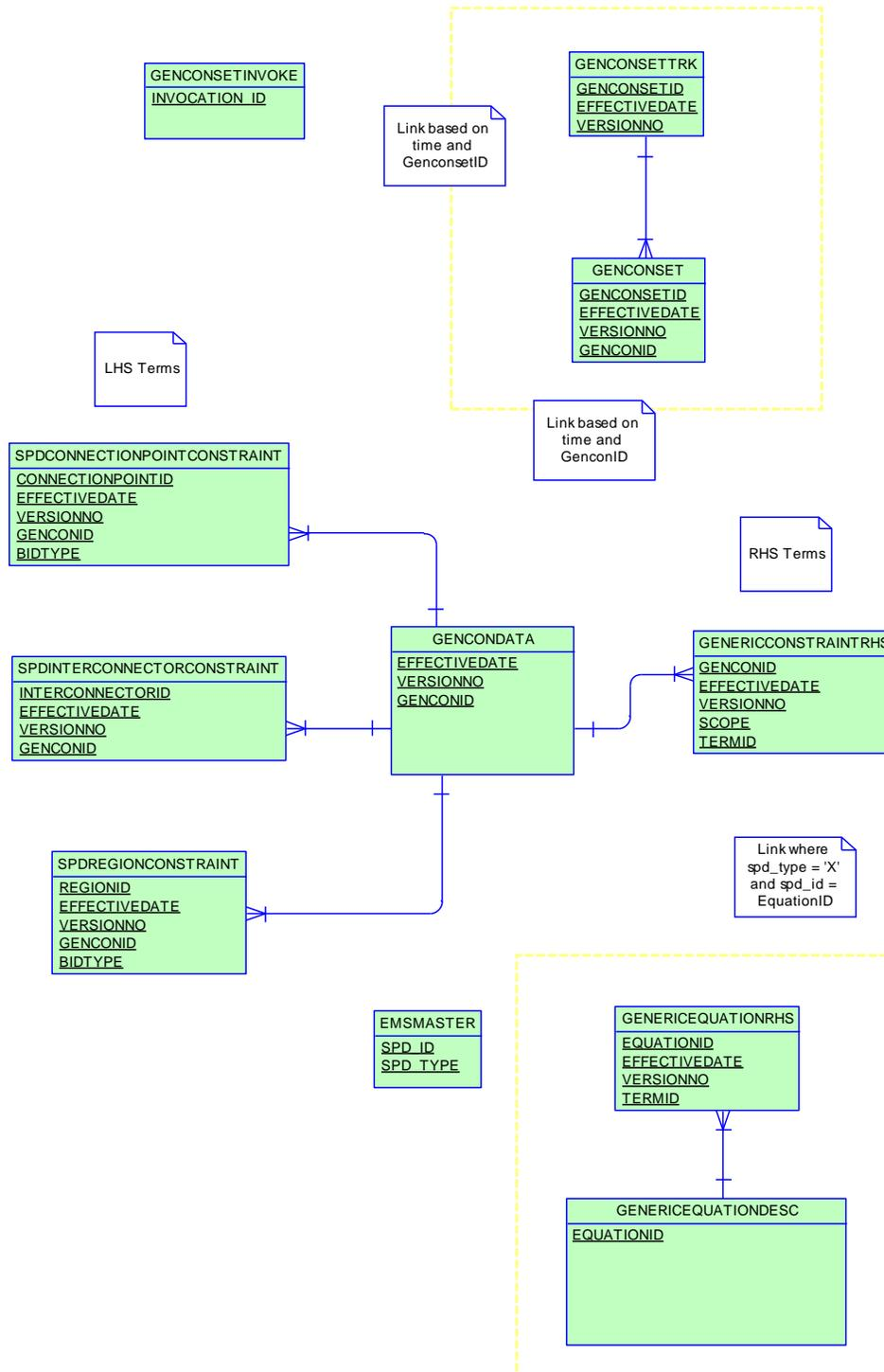

14.3 Table: EMSMASTER

14.3.1 EMSMASTER

Name	EMSMASTER
Comment	EMSMASTER provides a description of the SCADA measurements that are associated with the SPD_ID points utilised in generic equation RHS terms

14.3.2 Primary Key Columns

Name
SPD_ID
SPD_TYPE

14.3.3 Index Columns

Name
LASTCHANGED

14.3.4 Content

Name	Data Type	Mandatory	Comment
SPD_ID	VARCHAR(21)	X	ID defining data source
SPD_TYPE	VARCHAR(1)	X	ID describing type of data source
DESCRIPTION	VARCHAR(255))		The detailed description of the SCADA point associated with the SPD_ID
GROUPING_ID	VARCHAR(20)		The Grouping associated with the SPD ID - most often a RegionID

LASTCHANGED	DATE		Last date and time record changed
-------------	------	--	-----------------------------------

14.4 Table: GENCONDATA

14.4.1 GENCONDATA

Name	GENCONDATA
Comment	<p>GENCONDATA sets out the generic constraints contained within a generic constraint set invoked in PASA, predispatch and dispatch.</p> <p>Fields enable selective application of invoked constraints in the Dispatch, Predispatch, ST PASA or MT PASA processes.</p>

14.4.2 Description

GENCONDATA is a public data, and is available to all participants.

Source

GENCONDATA updates as constraint details are updated by AEMO.

Note

The following fields enable selective application of invoked constraints in the Dispatch, Predispatch, ST PASA or MT PASA processes:

- DISPATCH
- PREDISPATCH
- STPASA
- MTPASA

The flag P5MIN_SCOPE_OVERRIDE indicates for each constraint whether 5MPD makes use of the default Dispatch (P5MIN_SCOPE_OVERRIDE = NULL) or Pre-dispatch (P5MIN_SCOPE_OVERRIDE = 'PD') style RHS definition. GENERICCONSTRAINTRHS stores generic constraint RHS definitions. Constraints without records in GENERICCONSTRAINTRHS only make use of the static RHS defined in the CONSTRAINTVALUE column in GENCONDATA .

The default value for the P5MIN_SCOPE_OVERRIDE column is NULL, so constraints existing before implementing the column use the DISPATCH RHS definition by default, as was the case before the implementation of the change.

14.4.3 Notes

Name	Comment	Value
Visibility	Data in this table is:	Public

14.4.4 Primary Key Columns

Name

EFFECTIVEDATE

GENCONID

VERSIONNO

14.4.5 Index Columns

Name

LASTCHANGED

14.4.6 Content

Name	Data Type	Mandatory	Comment
EFFECTIVEDATE	DATE	X	Effective date of this constraint
VERSIONNO	NUMBER(3,0)	X	Version with respect to the effective date
GENCONID	VARCHAR2(20)	X	Unique ID for the constraint
CONSTRAINTTYPE	VARCHAR2(2)		The logical operator (=, >=, <=)
CONSTRAINTVALUE	NUMBER(16,6)		the RHS value used if there is no dynamic RHS defined in GenericConstraintRHS
DESCRIPTION	VARCHAR2(256)		Detail of the plant that is not in service
STATUS	VARCHAR2(8)		Not used

GENERICCONSTRAINTWEIGHT	NUMBER(16,6)		The constraint violation penalty factor
AUTHORISEDDATE	DATE		Date record authorised
AUTHORISEDBY	VARCHAR2(15)		User authorising record
DYNAMICRHS	NUMBER(15,5)		Not used
LASTCHANGED	DATE		Last date and time record changed
DISPATCH	VARCHAR2(1)		Flag: constraint RHS used for Dispatch? 1-used, 0-not used
PREDISPATCH	VARCHAR2(1)		Flag to indicate if the constraint RHS is to be used for PreDispatch, 1-used, 0-not used
STPASA	VARCHAR2(1)		Flag to indicate if the constraint RHS is to be used for ST PASA, 1-used, 0-not used
MTPASA	VARCHAR2(1)		Flag to indicate if the constraint RHS is to be used for MT PASA, 1-used, 0-not used
IMPACT	VARCHAR2(64)		The device(s) that is affected by the constraint e.g. Interconnector, Generator(s) or Cutset
SOURCE	VARCHAR2(128)		The source of the constraint formulation
LIMITTYPE	VARCHAR2(64)		The limit type of the constraint e.g. Transient Stability, Voltage Stability
REASON	VARCHAR2(256)		The contingency or reason for the constraint
MODIFICATIONS	VARCHAR2(256)		Details of the changes made to this version of the constraint

ADDITIONALNOTES	VARCHAR2(256)		Extra notes on the constraint
P5MIN_SCOPE_OVERRIDE	VARCHAR2(2)		Extra notes on the constraint: NULL = Dispatch RHS applied in 5MPD, PD = PreDispatch RHS applied in 5MPD
LRC	VARCHAR2(1)		Flag to indicate if PASA LRC run uses the constraint; 1-used, 0-not used
LOR	VARCHAR2(1)		Flag to indicate if PASA LOR run uses the constraint; 1-used, 0-not used
FORCE_SCADA	NUMBER(1,0)		Flags Constraints for which NEMDE must use "InitialMW" values instead of "WhatOfInitialMW" for Intervention Pricing runs

14.5 Table: GENCONSET

14.5.1 GENCONSET

Name	GENCONSET
Comment	GENCONSET sets out generic constraint sets that are invoked and revoked, and may contain many generic constraints (GENCONDATA).

14.5.2 Description

GENCONSET is public data, and is available to all participants.

Source

GENCONSET updates as sets are updated by AEMO.

14.5.3 Notes

Name	Comment	Value
Visibility	Data in this table is:	Public

14.5.4 Primary Key Columns

- Name
- EFFECTIVEDATE
- GENCONID
- GENCONSETID
- VERSIONNO

14.5.5 Index Columns

- Name

LASTCHANGED

14.5.6 Content

Name	Data Type	Mandatory	Comment
GENCONSETID	VARCHAR2(20)	X	Unique ID for the Constraint Set
EFFECTIVEDATE	DATE	X	Date this record becomes effective
VERSIONNO	NUMBER(3,0)	X	Version no of the record for the given effective date
GENCONID	VARCHAR2(20)	X	Generic Constraint ID
GENCONEFFDATE	DATE		Since market start in 1998 these fields have not been used and any data that has been populated in the fields should be ignored
GENCONVERSIONNO	NUMBER(3,0)		Since market start in 1998 these fields have not been used and any data that has been populated in the fields should be ignored
LASTCHANGED	DATE		Last date and time record changed

14.6 Table: GENCONSETINVOKE

14.6.1 GENCONSETINVOKE

Name	GENCONSETINVOKE
Comment	<p>GENCONSETINVOKE provides details of invoked and revoked generic constraints. GENCONSETINVOKE is the key table for determining what constraints are active in dispatch, predispach and PASA.</p> <p>GENCONSETINVOKE also indicates whether constraints are for interconnector limits, ancillary services, etc.</p>

14.6.2 Description

GENCONSETINVOKE is public data. All participants have access to this data.

Source

GENCONSETINVOKE updates each time a generic constraint is invoked or revoke time is altered. Once past the time, these times cannot be altered.

Note

The Replica software does not handle the deletion of GENCONSETINVOKE records. To workaround this problem, the field STARTAUTHORISED BY indicates whether a constraint set invocation is applicable. A non-null value for the STARTAUTHORISED BY field indicates that the constraint invocation is active. Essentially inactive invocations have a null value for the STARTAUTHORISED BY field. To remove inactive invocations from queries on the GENCONSETINVOKE table, add the following text to the where clause "and STARTAUTHORISED BY is not null".

14.6.3 Notes

Name	Comment	Value
Visibility	Data in this table is:	Public

14.6.4 Primary Key Columns

Name
INVOCATION_ID

14.6.5 Index Columns

Name

LASTCHANGED

14.6.6 Content

Name	Data Type	Mandatory	Comment
INVOCATION_ID	NUMBER(9)	X	Abstract unique identifier for the record. Allows Invocations to be modified without affecting PK values
STARTDATE	DATE	X	Market date of start
STARTPERIOD	NUMBER(3,0)	X	The first dispatch interval of the invocation being the dispatch interval number starting from 1 at 04:05.
GENCONSETID	VARCHAR2(20)	X	Unique generic constraint set identifier
ENDDATE	DATE		Market date end
ENDPERIOD	NUMBER(3,0)		Dispatch interval number end
STARTAUTHORISED BY	VARCHAR2(15)		User authorising invoke, indicating a constraint set invocation is applicable (i.e. non-null). A null value indicates inactive invocation.
ENDAUTHORISED BY	VARCHAR2(15)		user authorising revoke.
INTERVENTION	VARCHAR2(1)		0 is not intervention, 1 is intervention and causes dispatch

			to solve twice.
ASCONSTRAINTTYPE	VARCHAR2(10)		Constraint type (e.g. ancillary services). This also flags where a constraint is an interconnector or intra-region network limit.
LASTCHANGED	DATE		Last date and time record changed
STARTINTERVALDATETIME	DATE		The settlement date and time corresponding to the first interval to which the constraint set is to be applied.
ENDINTERVALDATETIME	DATE		The settlement date and time corresponding to the last interval to which the constraint set is to be applied.
SYSTEMNORMAL	VARCHAR2(1)		Flag to indicate if the constraint set is a system normal (1) or an outage set (0)

14.7 Table: GENCONSETTRK

14.7.1 GENCONSETTRK

Name	GENCONSETTRK
Comment	GENCONSETTRK assists in determining the correct version of a generic constraint set that has been invoked in GENCONSETINVOKE.

14.7.2 Description

GENCONSETTRK data is public to all participants.

Source

Ad hoc updates occur to GENCONSETTRK.

14.7.3 Notes

Name	Comment	Value
Visibility	Data in this table is:	Public

14.7.4 Primary Key Columns

Name

EFFECTIVEDATE

GENCONSETID

VERSIONNO

14.7.5 Index Columns

Name

LASTCHANGED

14.7.6 Content

Name	Data Type	Mandatory	Comment
GENCONSETID	VARCHAR2(20)	X	Unique ID for the Constraint Set
EFFECTIVEDATE	DATE	X	Date this record becomes effective
VERSIONNO	NUMBER(3,0)	X	Version no of the record for the given effective date
DESCRIPTION	VARCHAR2(256)		Description of the constraint
AUTHORISED BY	VARCHAR2(15)		The person who authorised the constraint set
AUTHORISED DATE	DATE		The date and time of authorising the constraint set
LASTCHANGED	DATE		Last date and time record changed
COVERAGE	VARCHAR2(64)		The region the constraint set is located in or a special grouping (e.g. CHIMERA)
MODIFICATIONS	VARCHAR2(256)		Details of the changes made to this version of the constraint set
SYSTEMNORMAL	VARCHAR2(1)		Not used as of 2005 End of Year Release [was Flag to indicate if the constraint set is a system normal (1) or and an outage set (0)]
OUTAGE	VARCHAR2(256)		Detail of the plant that is not in service

14.8 Table: GENERICCONSTRAINTRHS

14.8.1 GENERICCONSTRAINTRHS

Name	GENERICCONSTRAINTRHS
Comment	<p>GENERICCONSTRAINTRHS sets out details of generic constraint Right Hand Side (RHS) formulations for dispatch (DS), predispach (PD) and Short Term PASA (ST). GENERICCONSTRAINTRHS also includes general expressions (EQ) used in the dispatch, predispach and PASA time frames.</p> <p>GENERICCONSTRAINTRHS replaces data previously available via the "Constraint Library" Excel spreadsheet.</p>

14.8.2 Description

GENERICCONSTRAINTRHS is public data, and is available to all participants.

Source

GENERICCONSTRAINTRHS updates whenever a new generic constraint RHS or expression is created or modified

Volume

Approximately 70,000 records per year

Note

GENERICCONSTRAINTRHS and GENERICCONSTRAINTDESC allow commonly used constraint right hand side formulations to be defined as a generic equation. Once defined, the generic equation can be referenced from any Generic constraint RHS formulation defined in GENERICCONSTRAINTRHS.

14.8.3 Notes

Name	Comment	Value
Visibility	Data in this table is:	Public

14.8.4 Primary Key Columns

Name

EFFECTIVEDATE

GENCONID

SCOPE

TERMID

VERSIONNO

14.8.5 Index Columns

Name

LASTCHANGED

14.8.6 Content

Name	Data Type	Mandatory	Comment
GENCONID	VARCHAR2(20)	X	Generic Constraint Identifier
EFFECTIVEDATE	DATE	X	Effective date of this record
VERSIONNO	NUMBER(22,0)	X	Version no of this record for the effective date
SCOPE	VARCHAR2(2)	X	Scope of RHS term (DS, PD, ST or EQ)
TERMID	NUMBER(4,0)	X	The unique identifier for the a constraint RHS term
GROUPID	NUMBER(3,0)		ID of super-term, if this is a sub-term
SPD_ID	VARCHAR2(21)		ID defining data source

SPD_TYPE	VARCHAR2(1)		ID describing type of data source
FACTOR	NUMBER(16,6)		Multiplier applied to operator result
OPERATION	VARCHAR2(10))		Unitary operator to apply to data value
DEFAULTVALUE	NUMBER(16,6)		Default value if primary source given by SPD_ID and SPD_TYPE not available.
PARAMETERTERM1	VARCHAR2(12))		The unique identifier for the first term (logic expression) to use in a Branch term
PARAMETERTERM2	VARCHAR2(12))		The unique identifier for the second term (logic<=0 result) to use in a Branch term
PARAMETERTERM3	VARCHAR2(12))		The unique identifier for the third term (logic>0 result) to use in a Branch term
LASTCHANGED	DATE		Last date and time record changed

14.9 Table: GENERICEQUATIONDESC

14.9.1 GENERICEQUATIONDESC

Name	GENERICEQUATIONDESC
Comment	GENERICEQUATIONDESC defines a generic equation identifier with a description. The formulation of the generic equation is detailed in GENERICEQUATIONRHS.

14.9.2 Description

GENERICEQUATIONDESC data is public to all participants.

Source

GENERICEQUATIONDESC updates when new a generic equation is created for the first time.

Volume

Approximately 100 records per year

Note

GENERICEQUATIONRHS and GENERICEQUATIONDESC allow commonly used constraint right hand side formulations to be defined as a generic equation. Once defined, the generic equation can be referenced from any Generic constraint RHS formulation defined in GENERICCONSTRAINTRHS.

14.9.3 Notes

Name	Comment	Value
Visibility	Data in this table is:	Public

14.9.4 Primary Key Columns

Name	EQUATIONID
------	------------

14.9.5 Index Columns

Name

LASTCHANGED

14.9.6 Content

Name	Data Type	Mandatory	Comment
EQUATIONID	VARCHAR2(20)	X	Generic Equation Identifier
DESCRIPTION	VARCHAR2(256)		Generic Equation Description
LASTCHANGED	DATE		Last date and time record changed
IMPACT	VARCHAR2(64)		The device(s) affected by the constraint (e.g. Interconnector, Generator(s) or Cutset)
SOURCE	VARCHAR2(128)		The source of the constraint formulation
LIMITTYPE	VARCHAR2(64)		The limit type of the constraint e.g. Transient Stability, Voltage Stability
REASON	VARCHAR2(256)		The contingency or reason for the constraint
MODIFICATIONS	VARCHAR2(256)		Details of the changes made to this version of the generic equation RHS
ADDITIONALNOTES	VARCHAR2(256)		Extra notes on the constraint

14.10 Table: GENERICEQUATIONRHS

14.10.1 GENERICEQUATIONRHS

Name	GENERICEQUATIONRHS
Comment	GENERICEQUATIONRHS stores the formulation of commonly used Generic Constraint Right Hand Side Equations referenced from Generic Constraint Right Hand Side definitions stored in GENERICCONSTRAINTRHS. The Generic Equation definitions are versioned and the latest effective version is applied to the dispatch process.

14.10.2 Description

GENERICEQUATIONRHS data is public to all participants.

Source

GENERICEQUATIONRHS updates whenever a generic equation is created or modified.

Volume

Approximately 1,000 records per year

Note

GENERICEQUATIONRHS and GENERICEQUATIONDESC allow commonly used constraint right hand side formulations to be defined as a generic equation. Once defined, the generic equation can be referenced from any Generic constraint RHS formulation defined in GENERICCONSTRAINTRHS.

To reference a generic equation from a generic constraint RHS definition, specify a SPD_TYPE of 'X' and the SPD_ID equivalent to the EQUATIONID field in GENERICEQUATIONRHS.

14.10.3 Notes

Name	Comment	Value
Visibility	Data in this table is:	Public

14.10.4 Primary Key Columns

Name	EFFECTIVEDATE
------	---------------

EQUATIONID

TERMID

VERSIONNO

14.10.5 Index Columns

Name

LASTCHANGED

14.10.6 Content

Name	Data Type	Mandatory	Comment
EQUATIONID	VARCHAR2(20)	X	Generic Equation Identifier
EFFECTIVEDATE	DATE	X	Effective date of this record
VERSIONNO	NUMBER(3,0)	X	Version no of this record for the effective date
TERMID	NUMBER(3,0)	X	The unique identifier for the a equation RHS term
GROUPID	NUMBER(3,0)		ID of super-term, if this is a sub-term
SPD_ID	VARCHAR2(21)		ID defining data source
SPD_TYPE	VARCHAR2(1)		ID describing type of data source
FACTOR	NUMBER(16,6)		Multiplier applied to operator result
OPERATION	VARCHAR2(10)		Unitary operator to apply to data

)		value
DEFAULTVALUE	NUMBER(16,6)		Default value if primary source given by SPD_ID and SPD_TYPE not available.
PARAMETERTERM1	VARCHAR2(12))		The unique identifier for the first term (logic expression) to use in a Branch term
PARAMETERTERM2	VARCHAR2(12))		The unique identifier for the second term (logic<=0 result) to use in a Branch term
PARAMETERTERM3	VARCHAR2(12))		The unique identifier for the third term (logic>0 result) to use in a Branch term
LASTCHANGED	DATE		Last date and time record changed

14.11 Table: SPDCONNECTIONPOINTCONSTRAINT

14.11.1 SPDCONNECTIONPOINTCONSTRAINT

Name	SPDCONNECTIONPOINTCONSTRAINT
Comment	SPDCONNECTIONPOINTCONSTRAINT sets out details of connections point constraints issued in dispatch, predispatch and STPASA.

14.11.2 Description

The addition of the BIDTYPE field to SPDCONNECTIONPOINTCONSTRAINT allows constraints to be applied to a dispatchable unit energy and/or Frequency Controlled Ancillary Services dispatch.

SPDCONNECTIONPOINTCONSTRAINT data is public, so is available to all participants.

Source

SPDCONNECTIONPOINTCONSTRAINT updates whenever new connection point constraints are created.

14.11.3 Notes

Name	Comment	Value
Visibility	Data in this table is:	Public

14.11.4 Primary Key Columns

- Name
- BIDTYPE
- CONNECTIONPOINTID
- EFFECTIVEDATE
- GENCONID
- VERSIONNO

14.11.5 Index Columns

Name

LASTCHANGED

14.11.6 Content

Name	Data Type	Mandatory	Comment
CONNECTIONPOINTID	VARCHAR2(12)	X	Connection Point Identifier
EFFECTIVEDATE	DATE	X	Effective date of this record
VERSIONNO	NUMBER(3,0)	X	Version no of this record for the effective date
GENCONID	VARCHAR2(20)	X	Generic Constraint Identifier
FACTOR	NUMBER(16,6)		Constraint factor
LASTCHANGED	DATE		Last date and time record changed
BIDTYPE	VARCHAR2(12)	X	Bid Type Identifier; one of (RAISE6SEC, RAISE60SEC, RAISE5MIN, LOWER6SEC, LOWER60SEC, LOWER5MIN, RAISEREG, LOWERREG)

14.12 Table: SPDINTERCONNECTORCONSTRAINT

14.12.1 SPDINTERCONNECTORCONSTRAINT

Name	SPDINTERCONNECTORCONSTRAINT
Comment	SPDINTERCONNECTORCONSTRAINT contains details on the interconnector constraint factors used in dispatch, predispach and STPASA. The details set a LHS value.

14.12.2 Description

SPDINTERCONNECTORCONSTRAINT is public data, and is available to all participants.

Source

SPDINTERCONNECTORCONSTRAINT updates whenever new connection point constraints are created.

14.12.3 Notes

Name	Comment	Value
Visibility	Data in this table is:	Public

14.12.4 Primary Key Columns

- Name
- EFFECTIVEDATE
- GENCONID
- INTERCONNECTORID
- VERSIONNO

14.12.5 Index Columns

- Name

LASTCHANGED

14.12.6 Content

Name	Data Type	Mandatory	Comment
INTERCONNECTORID	VARCHAR2(10)	X	Interconnector Identifier
EFFECTIVEDATE	DATE	X	Effective date of this record
VERSIONNO	NUMBER(3,0)	X	Version no of this record for the effective date
GENCONID	VARCHAR2(20)	X	Generic Constraint Identifier
FACTOR	NUMBER(16,6)		Constraint factor
LASTCHANGED	DATE		Last date and time record changed

14.13 Table: SPDREGIONCONSTRAINT

14.13.1 SPDREGIONCONSTRAINT

Name	SPDREGIONCONSTRAINT
Comment	SPDREGIONCONSTRAINT contains details on region demand constraint factors used in dispatch. SPDREGIONCONSTRAINT sets a LHS value.

14.13.2 Description

SPDREGIONCONSTRAINT is public data, and is available to all participants.

Source

SPDREGIONCONSTRAINT is updated whenever AEMO creates new regional constraints.

14.13.3 Notes

Name	Comment	Value
Visibility	Data in this table is:	Public

14.13.4 Primary Key Columns

Name

BIDTYPE

EFFECTIVEDATE

GENCONID

REGIONID

VERSIONNO

14.13.5 Index Columns

Name

LASTCHANGED

14.13.6 Content

Name	Data Type	Mandatory	Comment
REGIONID	VARCHAR2(10)	X	Region Identifier
EFFECTIVEDATE	DATE	X	Effective date of this record
VERSIONNO	NUMBER(3,0)	X	Version no of this record for the effective date
GENCONID	VARCHAR2(20)	X	Generic Constraint Identifier
FACTOR	NUMBER(16,6)		Constraint factor; one of (-1, 1)
LASTCHANGED	DATE		Last date and time record changed
BIDTYPE	VARCHAR2(10)	X	AS Service type - relates to the BidType table; one of (RAISE6SEC, RAISE60SEC, RAISE5MIN, LOWER6SEC, LOWER60SEC, LOWER5MIN, RAISEREG, LOWERREG)

15 Package: IRAUCTION

<i>Name</i>	IRAUCTION
<i>Comment</i>	Inter-regional Residue Auction data

15.1 List of tables

Name	Comment
AUCTION	AUCTION holds auction details. AUCTION is new in March 2003 to support SRA Inter-Temporal Linking.
AUCTION_CALENDAR	AUCTION_CALENDAR holds the definitions of each auction quarter in a contract year. AUCTION_CALENDAR supports the Settlement Residue Auction.
AUCTION_IC_ALLOCATIONS	AUCTION_IC_ALLOCATIONS supports the Settlement Residue Auction by providing the basis for setting up contracts for individual tranches. AUCTION_IC_ALLOCATIONS shows the default definitions for the total number of units and proportion applicable to each directional interconnector for a specified auction quarter.
AUCTION_REVENUE_ESTIMATE	AUCTION_REVENUE_ESTIMATE supports the Settlement Residue Auction, by holding the evaluator's estimates of revenue for each month of a given quarter. Since reserve prices are no longer applicable from the end of 2001, zero is used as a default to avoid rewriting the system.
AUCTION_REVENUE_TRACK	AUCTION_REVENUE_TRACK supports the Settlement Residue Auction, by holding the tracking information for each evaluator's estimates for a given quarter. The status field is dynamic and is used for selection of estimates to be published.

AUCTION_RP_ESTIMATE	<p>AUCTION_RP_ESTIMATE supports the Settlement Residue Auction, by holding the evaluator's estimates of revenue prices for a given quarter.</p> <p>Since reserve prices are no longer applicable from the end of 2001, zero is used as a default to avoid rewriting the system.</p>
AUCTION_TRANCHE	<p>AUCTION_TRANCHE supports the Settlement Residue Auction, by holding the default definitions for the percentage number of units allocated and dates applicable to each tranche for a specified auction quarter. This information provides the basis for setting up contracts for individual tranches.</p>
RESIDUE_BID_TRK	<p>RESIDUE_BID_TRK supports the Settlement Residue Auction, by detailing which bid was used for which SRA Contract run.</p>
RESIDUE_CON_DATA	<p>RESIDUE_CON_DATA supports the Settlement Residue Auction, by holding for each participant the confidential data from the auction. RESIDUE_CON_DATA joins to RESIDUE_PUBLIC_DATA and RESIDUE_TRK.</p>
RESIDUE_CON_ESTIMATES_TRK	<p>RESIDUE_CON_ESTIMATES_TRK supports the Settlement Residue Auction, by holding the tracking details of the estimates used to generate the reserve price for each contract.</p>
RESIDUE_CON_FUNDS	<p>RESIDUE_CON_FUNDS supports the Settlement Residue Auction, by holding the fund details for each contract.</p>
RESIDUE_CONTRACTS	<p>RESIDUE_CONTRACTS supports the Settlement Residue Auction, by holding the contract details for each period for which a residue contract will be offered.</p>
RESIDUE_FUNDS_BID	<p>RESIDUE_FUNDS_BID supports the Settlement Residue Auction, by showing the fund details for each SRA bid by each Participant.</p>
RESIDUE_PRICE_BID	<p>RESIDUE_PRICE_BID supports the Settlement Residue Auction, holding the unit and bid price details for each</p>

	participant.
RESIDUE_PRICE_FUNDS_BID	RESIDUE_PRICE_FUNDS_BID shows the bids producing the auction outcome, without exposing participant-specific details. RESIDUE_PRICE_FUNDS_BID is new in March 2003 to support SRA Inter-Temporal Linking.
RESIDUE_PUBLIC_DATA	RESIDUE_PUBLIC_DATA shows the public auction results. RESIDUE_PUBLIC_DATA supports the Settlement Residue Auction, by holding the public details of the auction for a given contract. RESIDUE_PUBLIC_DATA joins to RESIDUE_CON_DATA and RESIDUE.
RESIDUE_TRK	RESIDUE_TRK supports the Settlement Residue Auction, by showing the tracking records for different residue auction runs. RESIDUE_TRK joins to RESIDUE_PUBLIC_DATA and RESIDUE_CON_DATA.
RESIDUECONTRACTPAYMENTS	RESIDUECONTRACTPAYMENTS shows Settlement Residue Auction payment Participant notifications.
RESIDUEFILETRK	RESIDUEFILETRK records all Settlement Residue Auction offers submitted by participants.
SRA_CASH_SECURITY	Records the Cash Security details provided by an SRA Auction Participant as collateral to cover their Trading Position in the SRA market
SRA_FINANCIAL_AUC_MARDET AIL	This table stores details of the margins returned to the participants.
SRA_FINANCIAL_AUC_MARGIN	Records the amount of Cash Security required to be held by an Auction Participant after settlement
SRA_FINANCIAL_AUC_RECEIPTS	Records details of the Cancelled Units and their value for the Auction Participant
SRA_FINANCIAL_AUCPAY_DETA IL	Records details of the SRA financial auction payment

SRA_FINANCIAL_AUCPAY_SUM	Records a summary of the Auction payment amount
SRA_FINANCIAL_RUNTRK	Records details of the settlement process for the cancellation and purchase of SRA Auction Units
SRA_OFFER_PRODUCT	Holds the Product details for each Offer File submitted by each SRA Auction Participant.
SRA_OFFER_PROFILE	Holds the data of an SRA Auction Participant Offer Submission.
SRA_PRUDENTIAL_CASH_SECURITY	Records the Cash Security details provided by an SRA Auction Participant as collateral to cover their Trading Position in the SRA market
SRA_PRUDENTIAL_COMP_POSITION	The prudential position of each company at the date and time of a specific prudential run
SRA_PRUDENTIAL_EXPOSURE	Records details of the Prudential Exposure of an SRA Auction Participant
SRA_PRUDENTIAL_RUN	Records the prudential run details for each prudential date
VALUATIONID	VALUATIONID shows the identifiers and descriptions of the valuers submitting estimates of upcoming settlement residues. VALUATIONID supports the Settlement Residue Auction.

15.2 Diagram: Entities: IRAuction

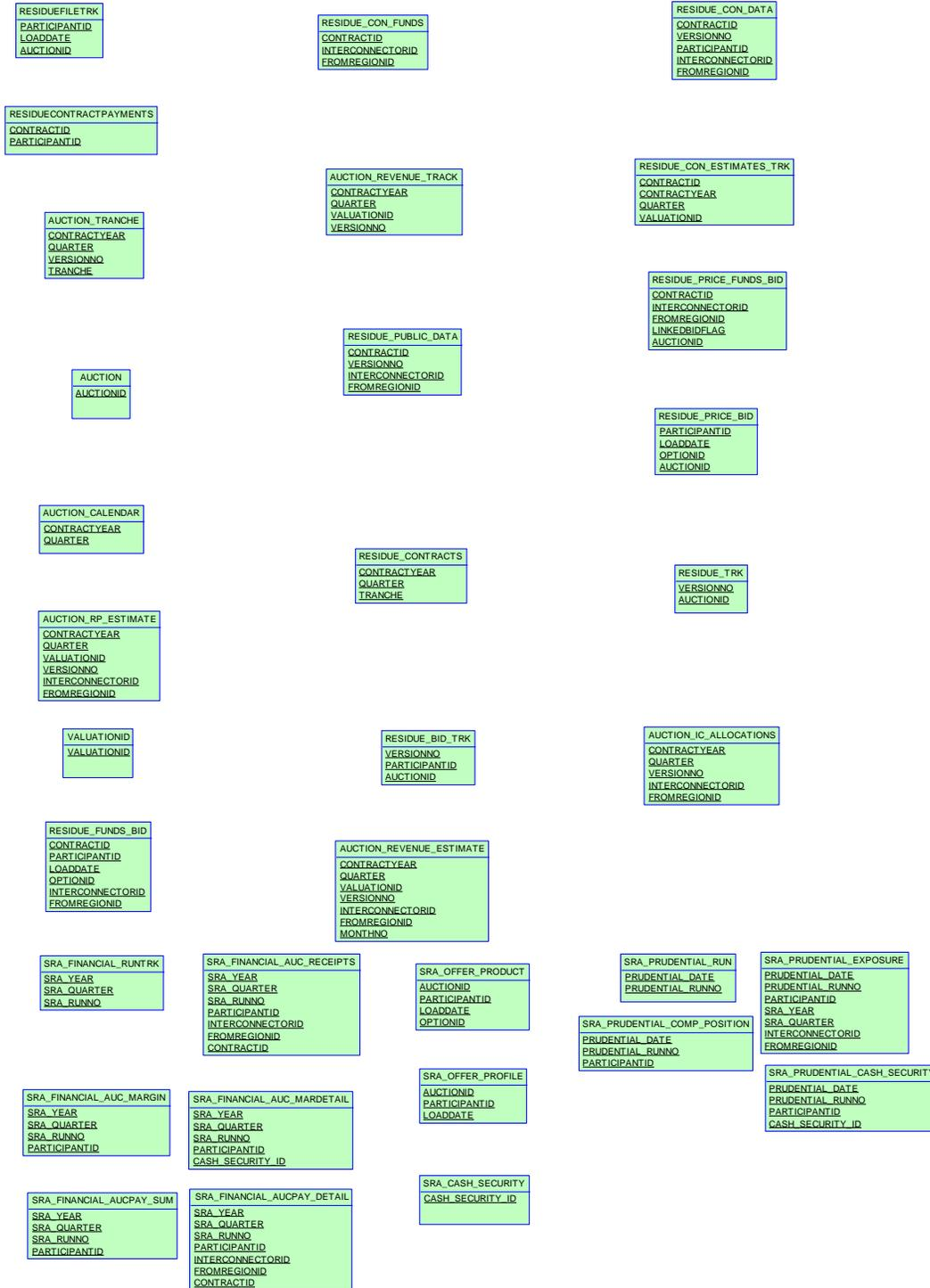

15.3 Table: AUCTION

15.3.1 AUCTION

Name	AUCTION
Comment	AUCTION holds auction details. AUCTION is new in March 2003 to support SRA Inter-Temporal Linking.

15.3.2 Description

AUCTION is public data, and is available to all participants.

Source

Static.

Volume

4 records per year

15.3.3 Notes

Name	Comment	Value
Visibility	Data in this table is:	Public

15.3.4 Primary Key Columns

Name
AUCTIONID

15.3.5 Index Columns

Name
LASTCHANGED

15.3.6 Content

Name	Data Type	Mandatory	Comment
AUCTIONID	VARCHAR2(30)	X	Unique id for each auction date
AUCTIONDATE	DATE		Auction date
NOTIFYDATE	DATE		
STARTDATE	DATE		Open date for bidding
ENDDATE	DATE		Close date for bidding
DESCRIPTION	VARCHAR2(100)		Description of an auction
AUTHORISEDDATE	DATE		
AUTHORISEDBY	VARCHAR2(30)		
LASTCHANGED	DATE		

15.4 Table: AUCTION_CALENDAR

15.4.1 AUCTION_CALENDAR

Name	AUCTION_CALENDAR
Comment	AUCTION_CALENDAR holds the definitions of each auction quarter in a contract year. AUCTION_CALENDAR supports the Settlement Residue Auction.

15.4.2 Description

AUCTION_CALENDAR is public data, and is available to all participants.

Source

Updates are usually quarterly by the SRA team.

Volume

AUCTION_CALENDAR shows a maximum of 16 records per year.

15.4.3 Notes

Name	Comment	Value
Visibility	Data in this table is:	Public

15.4.4 Primary Key Columns

- Name
- CONTRACTYEAR
- QUARTER

15.4.5 Index Columns

- Name
- LASTCHANGED

15.4.6 Content

Name	Data Type	Mandatory	Comment
CONTRACTYEAR	NUMBER(4,0)	X	SRA Contracted Year
QUARTER	NUMBER(1,0)	X	SRA Contracted Quarter
STARTDATE	DATE		First day of SRA Contract Quarter expressed as Date
ENDDATE	DATE		Last day of SRA Contract Quarter expressed as Date
NOTIFYDATE	DATE		Default notification date
PAYMENTDATE	DATE		Date for payment by Participant
RECONCILIATIONDATE	DATE		Date of reconciliation for the quarter
LASTCHANGED	DATE		Last date and time record changed
PRELIMPURCHASESTMTDATE	DATE		The date the Prelim Purchase Statement is generated
PRELIMPROCEEDSSTMTDATE	DATE		The date the Prelim Proceeds Statement is generated
FINALPURCHASESTMTDATE	DATE		The date the Final Purchase Statement is generated
FINALPROCEEDSSTMTDATE	DATE		The date the Final Proceeds Statement is generated

15.5 Table: AUCTION_IC_ALLOCATIONS

15.5.1 AUCTION_IC_ALLOCATIONS

Name	AUCTION_IC_ALLOCATIONS
Comment	AUCTION_IC_ALLOCATIONS supports the Settlement Residue Auction by providing the basis for setting up contracts for individual tranches. AUCTION_IC_ALLOCATIONS shows the default definitions for the total number of units and proportion applicable to each directional interconnector for a specified auction quarter.

15.5.2 Description

AUCTION_IC_ALLOCATIONS is public data, and is available to all participants.

Source

Updates are usually quarterly as auctions are held from Settlement Residue Auction team's SRIS interface.

Volume

AUCTION_IC_ALLOCATIONS contains a maximum of 100 records per year.

15.5.3 Notes

Name	Comment	Value
Visibility	Data in this table is:	Public

15.5.4 Primary Key Columns

- Name
- CONTRACTYEAR
- FROMREGIONID
- INTERCONNECTORID
- QUARTER
- VERSIONNO

15.5.5 Index Columns

Name

LASTCHANGED

15.5.6 Content

Name	Data Type	Mandatory	Comment
CONTRACTYEAR	NUMBER(4,0)	X	SRA Contracted Year
QUARTER	NUMBER(1,0)	X	SRA Contracted Quarter
VERSIONNO	NUMBER(3,0)	X	Version of data for other key data - a higher version for same key data takes precedence
INTERCONNECTORID	VARCHAR2(10)	X	Contracted Interconnector Identifier
FROMREGIONID	VARCHAR2(10)	X	Nominated source region for Interconnector
MAXIMUMUNITS	NUMBER(5,0)		Number of units on the interconnector
PROPORTION	NUMBER(8,5)		Percentage of the total residue for each Unit
AUCTIONFEE	NUMBER(17,5)		Daily auction fee
CHANGEDATE	DATE		Authorisation date
CHANGEDBY	VARCHAR2(15)		Name of person authorising this data set
LASTCHANGED	DATE		Last date and time record changed
AUCTIONFEE_SALES	Number(18,8)		Fees for Cancelled Units.

15.6 Table: AUCTION_REVENUE_ESTIMATE

15.6.1 AUCTION_REVENUE_ESTIMATE

Name	AUCTION_REVENUE_ESTIMATE
Comment	<p>AUCTION_REVENUE_ESTIMATE supports the Settlement Residue Auction, by holding the evaluator’s estimates of revenue for each month of a given quarter.</p> <p>Since reserve prices are no longer applicable from the end of 2001, zero is used as a default to avoid rewriting the system.</p>

15.6.2 Description

AUCTION_REVENUE_ESTIMATE is public data, and is available to all participants.

Source

Updates are quarterly from SRA team via SRIS interface

Volume

AUCTION_REVENUE_ESTIMATE contains a maximum of 300 records per year.

15.6.3 Notes

Name	Comment	Value
Visibility	Data in this table is:	Public

15.6.4 Primary Key Columns

- Name
- CONTRACTYEAR
- FROMREGIONID
- INTERCONNECTORID
- MONTHNO

QUARTER

VALUATIONID

VERSIONNO

15.6.5 Index Columns

Name

LASTCHANGED

15.6.6 Content

Name	Data Type	Mandatory	Comment
CONTRACTYEAR	NUMBER(4,0)	X	SRA Contracted Year
QUARTER	NUMBER(1,0)	X	SRA Contracted Quarter
VALUATIONID	VARCHAR2(15)	X	Identifier of the estimator
VERSIONNO	NUMBER(3,0)	X	Version of data for other key data - a higher version for same key data will take precedence
INTERCONNECTORID	VARCHAR2(10)	X	Contracted Interconnector
FROMREGIONID	VARCHAR2(10)	X	Nominated source region for Interconnector
MONTHNO	NUMBER(1,0)	X	Month number within quarter (1..3)
STARTDATE	DATE		First day of month as date
ENDDATE	DATE		Last day of month as date

REVENUE	NUMBER(17,5)		Estimated Revenue
LASTCHANGED	DATE		Last date and time record changed

15.7 Table: AUCTION_REVENUE_TRACK

15.7.1 AUCTION_REVENUE_TRACK

Name	AUCTION_REVENUE_TRACK
Comment	AUCTION_REVENUE_TRACK supports the Settlement Residue Auction, by holding the tracking information for each evaluator's estimates for a given quarter. The status field is dynamic and is used for selection of estimates to be published.

15.7.2 Description

AUCTION_REVENUE_TRACK is public data, and is available to all participants.

Source

Updates are quarterly after SRA team updates SRIS interface.

Volume

AUCTION_REVENUE_TRACK contains a maximum of 100 records per year.

15.7.3 Notes

Name	Comment	Value
Visibility	Data in this table is:	Public

15.7.4 Primary Key Columns

- Name
- CONTRACTYEAR
- QUARTER
- VALUATIONID
- VERSIONNO

15.7.5 Index Columns

Name

LASTCHANGED

15.7.6 Content

Name	Data Type	Mandatory	Comment
CONTRACTYEAR	NUMBER(4,0)	X	SRA Contracted Year
QUARTER	NUMBER(1,0)	X	SRA Contracted Quarter
VALUATIONID	VARCHAR2(15)	X	Identifier of the estimator
VERSIONNO	NUMBER(3,0)	X	Version of data for other key data - a higher version for same key data takes precedence
EFFECTIVEDATE	DATE		Date from which the record change is applicable
STATUS	VARCHAR2(10)		Internal use
DOCUMENTREF	VARCHAR2(30)		Reference to methodology document
AUTHORISEDDATE	DATE		Date of authorisation for this record
AUTHORISEDBY	VARCHAR2(15)		Name of person authorising this record
LASTCHANGED	DATE		Date and time this record was last changed

15.8 Table: AUCTION_RP_ESTIMATE

15.8.1 AUCTION_RP_ESTIMATE

Name AUCTION_RP_ESTIMATE

Comment AUCTION_RP_ESTIMATE supports the Settlement Residue Auction, by holding the evaluator’s estimates of revenue prices for a given quarter.

Since reserve prices are no longer applicable from the end of 2001, zero is used as a default to avoid rewriting the system.

15.8.2 Description

AUCTION_RP_ESTIMATE is public data, and is available to all participants.

Source

Updates are quarterly by SRA team via SRIS interface.

Volume

This view contains a maximum of 100 records per year.

15.8.3 Notes

Name	Comment	Value
Visibility	Data in this table is:	Public

15.8.4 Primary Key Columns

Name

CONTRACTYEAR

FROMREGIONID

INTERCONNECTORID

QUARTER

VALUATIONID

VERSIONNO

15.8.5 Index Columns

Name

LASTCHANGED

15.8.6 Content

Name	Data Type	Mandatory	Comment
CONTRACTYEAR	NUMBER(4,0)	X	SRA Contracted Year
QUARTER	NUMBER(1,0)	X	SRA Contracted Quarter
VALUATIONID	VARCHAR2(15)	X	Identifier of the estimator
VERSIONNO	NUMBER(3,0)	X	Version of data for other key data - a higher version for same key data takes precedence
INTERCONNECTORID	VARCHAR2(10)	X	Contracted Interconnector
FROMREGIONID	VARCHAR2(10)	X	Nominated source region for Interconnector
RPESTIMATE	NUMBER(17,5)		Estimate of reserve price
LASTCHANGED	DATE		Last date and time record was changed

15.9 Table: AUCTION_TRANCHE

15.9.1 AUCTION_TRANCHE

Name	AUCTION_TRANCHE
Comment	AUCTION_TRANCHE supports the Settlement Residue Auction, by holding the default definitions for the percentage number of units allocated and dates applicable to each tranche for a specified auction quarter. This information provides the basis for setting up contracts for individual tranches.

15.9.2 Description

AUCTION_TRANCHE is public data, and is available to all participants.

Source

Updates are quarterly from SRA team via SRIS interface.

Volume

AUCTION_TRANCHE contains a maximum of 100 records per year.

15.9.3 Notes

Name	Comment	Value
Visibility	Data in this table is:	Public

15.9.4 Primary Key Columns

- Name
- CONTRACTYEAR
- QUARTER
- TRANCHE
- VERSIONNO

15.9.5 Index Columns

Name

LASTCHANGED

15.9.6 Content

Name	Data Type	Mandatory	Comment
CONTRACTYEAR	NUMBER(4,0)	X	SRA Contracted Year
QUARTER	NUMBER(1,0)	X	SRA Contracted Quarter
VERSIONNO	NUMBER(3,0)	X	Version of data for other key data - a higher version for same key data will take precedence
TRANCHE	NUMBER(2,0)	X	Label identifying the arbitrary segmented share of the Interconnector flow
AUCTIONDATE	DATE		Default date of the auction
NOTIFYDATE	DATE		Default date participants notified of details
UNITALLOCATION	NUMBER(18,8)		Percentage of units allocated to the tranche
CHANGEDATE	DATE		Date of changing this record
CHANGEDBY	VARCHAR2(15)		Name of person who changed this record
LASTCHANGED	DATE		Date and time record was last changed

15.10 Table: RESIDUE_BID_TRK

15.10.1 RESIDUE_BID_TRK

Name	RESIDUE_BID_TRK
Comment	RESIDUE_BID_TRK supports the Settlement Residue Auction, by detailing which bid was used for which SRA Contract run.

15.10.2 Description

Source

RESIDUE_BID_TRK updates are usually quarterly from participants before an Auction.
 RESIDUE_BID_TRK data is confidential to the relevant participant.
 RESIDUE_BID_TRK excludes contracts and versions without a valid publication date (i.e invalid bids are ignored).

Volume

Assuming monthly contracts, RESIDUE_BID_TRK shows a maximum of 500 records per year.

15.10.3 Notes

Name	Comment	Value
Visibility	Data in this table is:	Private

15.10.4 Primary Key Columns

- Name
- AUCTIONID
- PARTICIPANTID
- VERSIONNO

15.10.5 Index Columns

Name

LASTCHANGED

15.10.6 Content

Name	Data Type	Mandatory	Comment
CONTRACTID	VARCHAR2(30)		SRA Contract unique identifier
VERSIONNO	NUMBER(3,0)	X	Version of Bid used
PARTICIPANTID	VARCHAR2(10)	X	Identifier of participant
BIDLOADDATE	DATE		Date and time bid used
LASTCHANGED	DATE		Date and time this record was last changed
AUCTIONID	VARCHAR2(30)	X	Unique id for each auction date. (new in March 2003 to support SRA Inter-Temporal Linking)

15.11 Table: RESIDUE_CON_DATA

15.11.1 RESIDUE_CON_DATA

Name	RESIDUE_CON_DATA
Comment	RESIDUE_CON_DATA supports the Settlement Residue Auction, by holding for each participant the confidential data from the auction. RESIDUE_CON_DATA joins to RESIDUE_PUBLIC_DATA and RESIDUE_TRK.

15.11.2 Description

Source

RESIDUE_CON_DATA refreshes whenever a Settlement Residue Auction is run (i.e. quarterly).
RESIDUE_CON_DATA data is confidential to the relevant participant.
RESIDUE_CON_DATA excludes contracts and versions without a valid publication date (i.e invalid bids are ignored).

Volume

RESIDUE_CON_DATA shows a maximum of 6000 records per year.

15.11.3 Notes

Name	Comment	Value
Visibility	Data in this table is:	Private

15.11.4 Primary Key Columns

- Name
- CONTRACTID
- FROMREGIONID
- INTERCONNECTORID
- PARTICIPANTID

VERSIONNO

15.11.5 Index Columns

Name

LASTCHANGED

15.11.6 Content

Name	Data Type	Mandatory	Comment
CONTRACTID	VARCHAR2(30)	X	SRA Contract unique identifier
VERSIONNO	NUMBER(3,0)	X	Contract run version
PARTICIPANTID	VARCHAR2(10)	X	Identifier of Contracted Participant
INTERCONNECTORID	VARCHAR2(10)	X	Identifier of Contracted Interconnector
FROMREGIONID	VARCHAR2(10)	X	Nominated source region for Interconnector
UNITSPURCHASED	NUMBER(17,5)		Units purchased on the directional interconnector (i.e. Contracted quantity)
LINKPAYMENT	NUMBER(17,5)		Payment due (i.e. total purchase price)
LASTCHANGED	DATE		Last date and time record changed
SECONDARY_UNITS_SOLD	Number(18,8)		The number of cancelled Units for all Auction Participants.

15.12 Table: RESIDUE_CON_ESTIMATES_TRK

15.12.1 RESIDUE_CON_ESTIMATES_TRK

Name	RESIDUE_CON_ESTIMATES_TRK
Comment	RESIDUE_CON_ESTIMATES_TRK supports the Settlement Residue Auction, by holding the tracking details of the estimates used to generate the reserve price for each contract.

15.12.2 Description

Source

RESIDUE_CON_ESTIMATES_TRK updates are quarterly by SRA team.

Volume

Assuming monthly contracts, RESIDUE_CON_ESTIMATES_TRK shows a maximum of 50 records per year.

15.12.3 Notes

Name	Comment	Value
Visibility	Data in this table is:	Public

15.12.4 Primary Key Columns

- Name
- CONTRACTID
- CONTRACTYEAR
- QUARTER
- VALUATIONID

15.12.5 Index Columns

- Name

LASTCHANGED

15.12.6 Content

Name	Data Type	Mandatory	Comment
CONTRACTID	VARCHAR2(30)	X	SRA Contract unique identifier
CONTRACTYEAR	NUMBER(4,0)	X	AEMO Contract Year number starting in week containing 1st January
QUARTER	NUMBER(1,0)	X	Contract Quarter
VALUATIONID	VARCHAR2(15)	X	Identifier of the estimator
VERSIONNO	NUMBER(3,0)		Version of a record, as nominated by the participant
LASTCHANGED	DATE		Date and time this record was changed

15.13 Table: RESIDUE_CON_FUNDS

15.13.1 RESIDUE_CON_FUNDS

Name	RESIDUE_CON_FUNDS
Comment	RESIDUE_CON_FUNDS supports the Settlement Residue Auction, by holding the fund details for each contract.

15.13.2 Description

RESIDUE_CON_FUNDS data is public, so is available to all participants.

Source

RESIDUE_CON_FUNDS updates are quarterly from SRA team via SRIS interface.

Volume

Assuming quarterly contracts, RESIDUE_CON_FUNDS contains a maximum of 600 records per year.

15.13.3 Notes

Name	Comment	Value
Visibility	Data in this table is:	Public

15.13.4 Primary Key Columns

- Name
- CONTRACTID
- FROMREGIONID
- INTERCONNECTORID

15.13.5 Index Columns

- Name
- LASTCHANGED

15.13.6 Content

Name	Data Type	Mandatory	Comment
CONTRACTID	VARCHAR2(30)	X	SRA Contract unique identifier as specified by AEMO
INTERCONNECTORID	VARCHAR2(10)	X	Identifier for the Contracted Interconnector
FROMREGIONID	VARCHAR2(10)	X	Nominated source region for Interconnector
DEFAULTUNITS	NUMBER(5,0)		Actual number of units allocated based on the auction default percentage for the tranche and the total number of units to be auctioned for this quarter
ROLLOVERUNITS	NUMBER(5,0)		Units reallocated from the previous tranche of this quarter
REALLOCATEDUNITS	NUMBER(5,0)		Units reallocated from the previous tranche of this quarter because they were not taken up by the participant
UNITSOFFERED	NUMBER(5,0)		Total units offered for Contract
MEANRESERVEPRICE	NUMBER(9,2)		Average reserve price calculated from the selected estimates
SCALEFACTOR	NUMBER(8,5)		Scaling factor for regional Frequency control Ancillary Service requirement
ACTUALRESERVEPRICE	NUMBER(9,2)		Actual reserve price
LASTCHANGED	DATE		Last date and time record changed

15.14 Table: RESIDUE_CONTRACTS

15.14.1 RESIDUE_CONTRACTS

Name	RESIDUE_CONTRACTS
Comment	RESIDUE_CONTRACTS supports the Settlement Residue Auction, by holding the contract details for each period for which a residue contract will be offered.

15.14.2 Description

RESIDUE_CONTRACTS data is public, so is available to all participants.

Source

RESIDUE_CONTRACTS updates are quarterly by AEMO.

Volume

Assuming quarterly contracts, RESIDUE_CONTRACTS contains a maximum of 50 records per year.

15.14.3 Notes

Name	Comment	Value
Visibility	Data in this table is:	Public

15.14.4 Primary Key Columns

- Name
- CONTRACTYEAR
- QUARTER
- TRANCHE

15.14.5 Index Columns

- Name

LASTCHANGED

15.14.6 Content

Name	Data Type	Mandatory	Comment
CONTRACTYEAR	NUMBER(4,0)	X	SRA Contracted Year
QUARTER	NUMBER(1,0)	X	SRA Contracted Quarter
TRANCHE	NUMBER(2,0)	X	Label identifying the arbitrary segmented share of the Interconnector flow
CONTRACTID	VARCHAR2(30)		Unique identifier for each SRA Contract as specified by AEMO
STARTDATE	DATE		SRA Quarter start date
ENDDATE	DATE		SRA Quarter end date
NOTIFYDATE	DATE		Open date of bidding, calculated as RNOTIFYDATE business days before the auction date
AUCTIONDATE	DATE		Close date of bidding, calculated as RAUCDATE business days before the contract start date
CALCMETHOD	VARCHAR2(20)		Identifies methodology used
AUTHORISEDDATE	DATE		Authorisation date for this record
AUTHORISEDBY	VARCHAR2(15)		Name of authorising officer or process
NOTIFYPOSTDATE	DATE		Date notification posted
NOTIFYBY	VARCHAR2(15)		Name of notifying person

)		
POSTDATE	DATE		Date of publishing the auction results
POSTEDBY	VARCHAR2(15))		Name of publishing officer or process
LASTCHANGED	DATE		Last date and time record changed
DESCRIPTION	VARCHAR2(80))		Description of Contract
AUCTIONID	VARCHAR2(30))		Unique id for each auction date (new in March 2003 to support SRA Inter-Temporal Linking)

15.15 Table: RESIDUE_FUNDS_BID

15.15.1 RESIDUE_FUNDS_BID

Name	RESIDUE_FUNDS_BID
Comment	RESIDUE_FUNDS_BID supports the Settlement Residue Auction, by showing the fund details for each SRA bid by each Participant.

15.15.2 Description

Source

Participant's bid file.

RESIDUE_FUNDS_BID data is confidential to the relevant participant. RESIDUE_FUNDS_BID shows a maximum of 30,000 records per year.

15.15.3 Notes

Name	Comment	Value
Visibility	Data in this table is:	Private

15.15.4 Primary Key Columns

Name

CONTRACTID

FROMREGIONID

INTERCONNECTORID

LOADDATE

OPTIONID

PARTICIPANTID

15.15.5 Index Columns

Name

LASTCHANGED

15.15.6 Content

Name	Data Type	Mandatory	Comment
CONTRACTID	VARCHAR2(30)	X	SRA Contract identifier
PARTICIPANTID	VARCHAR2(10)	X	Participant identifier
LOADDATE	DATE	X	Date and time the batcher loaded the SRA offer
OPTIONID	NUMBER(3,0)	X	Unique option identifier (1..20)
INTERCONNECTORID	VARCHAR2(10)	X	Interconnector Identifier
FROMREGIONID	VARCHAR2(10)	X	Nominated source region for Interconnector
UNITS	NUMBER(5,0)		Quantity of units bid for
LASTCHANGED	DATE		Last date and time record changed

15.16 Table: RESIDUE_PRICE_BID

15.16.1 RESIDUE_PRICE_BID

Name	RESIDUE_PRICE_BID
Comment	RESIDUE_PRICE_BID supports the Settlement Residue Auction, holding the unit and bid price details for each participant.

15.16.2 Description

Source

The participant's own bid file
 RESIDUE_PRICE_BID data is confidential to the relevant participant.
 The public version of the data is available to all auction participants post the associated auction date in RESIDUE_PRICE_FUNDS_BID.

Volume

RESIDUE_PRICE_BID shows a maximum of 10,000 records per year.

15.16.3 Notes

Name	Comment	Value
Visibility	Data in this table is:	Private

15.16.4 Primary Key Columns

- Name
- AUCTIONID
- LOADDATE
- OPTIONID
- PARTICIPANTID

15.16.5 Index Columns

Name

LASTCHANGED

15.16.6 Content

Name	Data Type	Mandatory	Comment
CONTRACTID	VARCHAR2(30)		Not to be used. Unique id for each SRA contract (specified by AEMO)
PARTICIPANTID	VARCHAR2(10)	X	Participant identifier
LOADDATE	DATE	X	Date and Time the batcher loaded the bid
OPTIONID	NUMBER(3,0)	X	Unique option (bid) identifier (1..800)
BIDPRICE	NUMBER(17,5)		Price offered for each unit
LASTCHANGED	DATE		Date and time this record was last changed
AUCTIONID	VARCHAR2(30)	X	Unique id for each auction date (new in March 2003 to support SRA Inter-Temporal Linking)

15.17 Table: RESIDUE_PRICE_FUNDS_BID

15.17.1 RESIDUE_PRICE_FUNDS_BID

Name	RESIDUE_PRICE_FUNDS_BID
Comment	RESIDUE_PRICE_FUNDS_BID shows the bids producing the auction outcome, without exposing participant-specific details. RESIDUE_PRICE_FUNDS_BID is new in March 2003 to support SRA Inter-Temporal Linking.

15.17.2 Description

RESIDUE_PRICE_FUNDS_BID data is public. The data is available to all auction participants post the associated auction date.

Volume

The volume is very dependent on the number of active bids. An indication is about 250,000 per year.

15.17.3 Notes

Name	Comment	Value
Visibility	Data in this table is:	Public

15.17.4 Primary Key Columns

- Name
- AUCTIONID
- CONTRACTID
- FROMREGIONID
- INTERCONNECTORID
- LINKEDBIDFLAG

15.17.5 Index Columns

Name

LASTCHANGED

15.17.6 Content

Name	Data Type	Mandatory	Comment
CONTRACTID	VARCHAR2(30)	X	Unique id for each contract specified by AEMO
INTERCONNECTORID	VARCHAR2(10)	X	Unique interconnector identifier
FROMREGIONID	VARCHAR2(10)	X	Unique region identifier
UNITS	NUMBER(5,0)		Quantity of units bid
BIDPRICE	NUMBER(17,5)		Price bid for each unit
LINKEDBIDFLAG	NUMBER(6,0)	X	A unique option id, with respect to the auction, created to show which bid elements are linked.
AUCTIONID	VARCHAR2(30)	X	Unique id for each auction date
LASTCHANGED	DATE		Date and time this record was last changed

15.18 Table: RESIDUE_PUBLIC_DATA

15.18.1 RESIDUE_PUBLIC_DATA

Name RESIDUE_PUBLIC_DATA

Comment RESIDUE_PUBLIC_DATA shows the public auction results.
 RESIDUE_PUBLIC_DATA supports the Settlement Residue Auction, by holding the public details of the auction for a given contract.
 RESIDUE_PUBLIC_DATA joins to RESIDUE_CON_DATA and RESIDUE.

15.18.2 Description

RESIDUE_PUBLIC_DATA excludes contracts and versions without a valid publication date (i.e. invalid bids are ignored). The data is available to all auction participants post the associated auction date.

Source

RESIDUE_PUBLIC_DATA updates are quarterly from NEMMCO.

Volume

RESIDUE_PUBLIC_DATA shows a maximum of 120 records per year.

15.18.3 Notes

Name	Comment	Value
Visibility	Data in this table is:	Public

15.18.4 Primary Key Columns

Name

CONTRACTID

FROMREGIONID

INTERCONNECTORID

VERSIONNO

15.18.5 Index Columns

Name

LASTCHANGED

15.18.6 Content

Name	Data Type	Mandatory	Comment
CONTRACTID	VARCHAR2(30)	X	Unique id for each contract to be specified by AEMO
VERSIONNO	NUMBER(3,0)	X	Version Number
INTERCONNECTORID	VARCHAR2(10)	X	Unique interconnector identifier
FROMREGIONID	VARCHAR2(10)	X	Nominated source region for Interconnector
UNITSOFFERED	NUMBER(5,0)		Total units offered for auction
UNITSSOLD	NUMBER(16,6)		Units Sold (modified format and usage in March 2003 to support SRA Inter-Temporal Linking)
CLEARINGPRICE	NUMBER(17,5)		Clearing price
RESERVEPRICE	NUMBER(17,5)		Reserve price
LASTCHANGED	DATE		Date and time this record was last changed

15.19 Table: RESIDUE_TRK

15.19.1 RESIDUE_TRK

Name	RESIDUE_TRK
Comment	RESIDUE_TRK supports the Settlement Residue Auction, by showing the tracking records for different residue auction runs. RESIDUE_TRK joins to RESIDUE_PUBLIC_DATA and RESIDUE_CON_DATA.

15.19.2 Description

Source

RESIDUE_TRK updates whenever Settlement Residue Auctions are run and the results published (i.e. quarterly). The RESIDUE_TRK data is available to all participants post the associated auction date.

Volume

Assuming quarterly contracts, RESIDUE_TRK shows a maximum of 50 records per year.

15.19.3 Notes

Name	Comment	Value
Visibility	Data in this table is:	Public

15.19.4 Primary Key Columns

- Name
- AUCTIONID
- VERSIONNO

15.19.5 Index Columns

- Name
- LASTCHANGED

15.19.6 Content

Name	Data Type	Mandatory	Comment
CONTRACTID	VARCHAR2(30)		SRA Contract identifier
VERSIONNO	NUMBER(3,0)	X	Contract run version
RUNDATE	DATE		Date auction results determined
AUTHORISEDDATE	DATE		Date results published
AUTHORISEDBY	VARCHAR2(15)		Authorising officer or process
POSTDATE	DATE		Date the run is authorised
POSTEDBY	VARCHAR2(15)		Name of authorising officer or process
LASTCHANGED	DATE		Last date and time record changed
STATUS	VARCHAR2(15)		Load status [SUCCESSFUL/CORRUPT]
AUCTIONID	VARCHAR2(30)	X	Unique id for each auction date. (new in March 2003 to support SRA Inter-Temporal Linking)

15.20 Table: RESIDUECONTRACTPAYMENTS

15.20.1 RESIDUECONTRACTPAYMENTS

Name	RESIDUECONTRACTPAYMENTS
Comment	RESIDUECONTRACTPAYMENTS shows Settlement Residue Auction payment Participant notifications.

15.20.2 Description

RESIDUECONTRACTPAYMENTS data is confidential to the relevant participant.

15.20.3 Notes

Name	Comment	Value
Visibility	Data in this table is:	Private

15.20.4 Primary Key Columns

Name
 CONTRACTID
 PARTICIPANTID

15.20.5 Index Columns

Name
 LASTCHANGED

15.20.6 Content

Name	Data Type	Mandatory	Comment
------	-----------	-----------	---------

CONTRACTID	VARCHAR2(30)	X	SRA Contract ID
PARTICIPANTID	VARCHAR2(10)	X	Participant Identifier
LASTCHANGED	DATE		Date and time this record was last changed

15.21 Table: RESIDUEFILETRK

15.21.1 RESIDUEFILETRK

Name	RESIDUEFILETRK
Comment	RESIDUEFILETRK records all Settlement Residue Auction offers submitted by participants.

15.21.2 Description

RESIDUEFILETRK data is confidential to each participant

Source

RESIDUEFILETRK updates are ad hoc from participants

Volume

Assuming quarterly contracts RESIDUEFILETRK contains a maximum of 5,000 records per annum. Each bid file can contain many bids for each auction. Participants can input multiple bids (with the last acknowledged file being used in the auction).

15.21.3 Notes

Name	Comment	Value
Visibility	Data in this table is:	Private

15.21.4 Primary Key Columns

- Name
- AUCTIONID
- LOADDATE
- PARTICIPANTID

15.21.5 Index Columns

- Name

LASTCHANGED

15.21.6 Content

Name	Data Type	Mandatory	Comment
CONTRACTID	VARCHAR2(30)		SRA ContractID
PARTICIPANTID	VARCHAR2(10)	X	Participant Identifier
LOADDATE	DATE	X	Date-Time SRA offer was loaded
FILENAME	VARCHAR2(40)		SRA offer file name
ACKFILENAME	VARCHAR2(40)		SRA acknowledgment file name
STATUS	VARCHAR2(10)		Load status [SUCCESSFUL/CORRUPT]
LASTCHANGED	DATE		Last date and time record changed
AUCTIONID	VARCHAR2(30)	X	Unique id for each auction date. (new in March 2003 to support SRA Inter-Temporal Linking)

15.22 Table: SRA_CASH_SECURITY

15.22.1 SRA_CASH_SECURITY

Name	SRA_CASH_SECURITY
Comment	Records the Cash Security details provided by an SRA Auction Participant as collateral to cover their Trading Position in the SRA market

15.22.2 Primary Key Columns

Name	CASH_SECURITY_ID
------	------------------

15.22.3 Content

Name	Data Type	Mandatory	Comment
CASH_SECURITY_ID	VARCHAR2(36)	X	Unique identifier for the cash security.
PARTICIPANTID	VARCHAR2(10)		Unique identifier for the auction participant lodging the cash security.
PROVISION_DATE	DATE		Date AEMO received the Cash Security deposit
CASH_AMOUNT	NUMBER(18,8)		Dollar amount of the cash security.
INTEREST_ACCT_ID	VARCHAR2(20)		The interest account ID for calculating the interest payment
AUTHORISEDDATE	DATE		Authorised date
FINALRETURNDATE	DATE		Date the entire Cash Security amount was returned to the

			Auction Participant
CASH_SECURITY_RETURNED	NUMBER(18,8)		Returned Dollar amount of the Cash Security.
DELETIONDATE	DATE		Cash Security deleted date. For valid records, DeletionDate will be Null.
LASTCHANGED	DATE		The date and time this record was last modified

15.23 Table: SRA_FINANCIAL_AUC_MARDETAIL

15.23.1 SRA_FINANCIAL_AUC_MARDETAIL

Name SRA_FINANCIAL_AUC_MARDETAIL

Comment This table stores details of the margins returned to the participants.

15.23.2 Primary Key Columns

Name

CASH_SECURITY_ID

PARTICIPANTID

SRA_QUARTER

SRA_RUNNO

SRA_YEAR

15.23.3 Content

Name	Data Type	Mandatory	Comment
SRA_YEAR	NUMBER(4)	X	Year of the Tranche
SRA_QUARTER	NUMBER(3)	X	Relevant Quarter of the Tranche
SRA_RUNNO	NUMBER(3)	X	SRA Run Number
PARTICIPANTID	VARCHAR2(10)	X	The participant identifier.
CASH_SECURITY_ID	VARCHAR2(36)	X	Unique identifier for the cash security.
RETURNED_AMOUNT	NUMBER(18,8)		The amount returned to the Auction participant from this cash

			security.
RETURNED_INTEREST	NUMBER(18,8)		The amount of interest applicable to the returned amount.

15.24 Table: SRA_FINANCIAL_AUC_MARGIN

15.24.1 SRA_FINANCIAL_AUC_MARGIN

Name	SRA_FINANCIAL_AUC_MARGIN
Comment	Records the amount of Cash Security required to be held by an Auction Participant after settlement

15.24.2 Primary Key Columns

Name
PARTICIPANTID
SRA_QUARTER
SRA_RUNNO
SRA_YEAR

15.24.3 Content

Name	Data Type	Mandatory	Comment
SRA_YEAR	NUMBER(4)	X	Year of the Tranche
SRA_QUARTER	NUMBER(3)	X	Relevant Quarter of the Tranche
SRA_RUNNO	NUMBER(3)	X	SRA Run Number
PARTICIPANTID	VARCHAR2(10)	X	Unique participant identifier.
TOTAL_CASH_SECURITY	NUMBER(18,8)		Total cash security held by the participant.
REQUIRED_MARGIN	NUMBER(18,8)		The amount of trading cash security required to be held by the

			participant after settlement.
RETURNED_MARGIN	NUMBER(18,8)		The amount of cash security returned to the participant.
RETURNED_MARGIN_INTE REST	NUMBER(18,8)		The amount of interest applicable to returned cash security amounts.

15.25 Table: SRA_FINANCIAL_AUC_RECEIPTS

15.25.1 SRA_FINANCIAL_AUC_RECEIPTS

Name SRA_FINANCIAL_AUC_RECEIPTS

Comment Records details of the Cancelled Units and their value for the Auction Participant

15.25.2 Primary Key Columns

Name

CONTRACTID

FROMREGIONID

INTERCONNECTORID

PARTICIPANTID

SRA_QUARTER

SRA_RUNNO

SRA_YEAR

15.25.3 Content

Name	Data Type	Mandatory	Comment
SRA_YEAR	NUMBER(4)	X	Year of the Tranche
SRA_QUARTER	NUMBER(3)	X	Relevant Quarter of the Tranche
SRA_RUNNO	NUMBER(3)	X	SRA Run Number
PARTICIPANTID	VARCHAR2(10)	X	Unique participant identifier

INTERCONNECTORID	VARCHAR2(10))	X	The identifier for the Directional Interconnector
FROMREGIONID	VARCHAR2(10))	X	The source region identifier for the Directional Interconnector
CONTRACTID	VARCHAR2(10))	X	The SRA contract identifier
UNITS_PURCHASED	NUMBER(18,8)		The number of units purchased
CLEARING_PRICE	NUMBER(18,8)		The clearing price of the auction
RECEIPT_AMOUNT	NUMBER(18,8)		The payment amount owed to AEMO
LASTCHANGED	DATE		The last changed date for the record
PROCEEDS_AMOUNT	NUMBER(18,8)		Dollar value of Cancelled Units in the Auction for the Auction Participant
UNITS_SOLD	NUMBER(18,8)		Units cancelled in the auction by the Auction participant.

15.26 Table: SRA_FINANCIAL_AUCPAY_DETAIL

15.26.1 SRA_FINANCIAL_AUCPAY_DETAIL

Name	SRA_FINANCIAL_AUCPAY_DETAIL
Comment	Records details of the SRA financial auction payment

15.26.2 Primary Key Columns

Name

CONTRACTID

FROMREGIONID

INTERCONNECTORID

PARTICIPANTID

SRA_QUARTER

SRA_RUNNO

SRA_YEAR

15.26.3 Content

Name	Data Type	Mandatory	Comment
SRA_YEAR	NUMBER(4)	X	Year of the Tranche
SRA_QUARTER	NUMBER(3)	X	Relevant Quarter of the Tranche
SRA_RUNNO	NUMBER(3)	X	SRA Run Number
PARTICIPANTID	VARCHAR2(10)	X	Unique participant identifier
INTERCONNECTORID	VARCHAR2(10)	X	The identifier for the Directional

)		Interconnector
FROMREGIONID	VARCHAR2(10))	X	The source Region identifier for the Directional Interconnector
CONTRACTID	VARCHAR2(10))	X	The SRA contract identifier
MAXIMUM_UNITS	NUMBER(18,8)		The Maximum Units Available for purchase in the Auction
UNITS_SOLD	NUMBER(18,8)		The total number of Allocated Units in the Auction, including Cancelled Units by an Auction Participant
SHORTFALL_UNITS	NUMBER(18,8)		The total number of units unpaid for in the auction
RESERVE_PRICE	NUMBER(18,8)		The reserve price of the auction
CLEARING_PRICE	NUMBER(18,8)		The Market Clearing Price of the Auction
PAYMENT_AMOUNT	NUMBER(18,8)		The payment amount owed by AEMO before shortfall
SHORTFALL_AMOUNT	NUMBER(18,8)		The shortfall amount
ALLOCATION	NUMBER(18,8)		The percentage of the auction proceeds allocated to the TNSP on the directional link
NET_PAYMENT_AMOUNT	NUMBER(18,8)		The payment amount owed by AEMO, including shortfall
LASTCHANGED	DATE		The date and time this record was last modified

15.27 Table: SRA_FINANCIAL_AUCPAY_SUM

15.27.1 SRA_FINANCIAL_AUCPAY_SUM

Name SRA_FINANCIAL_AUCPAY_SUM

Comment Records a summary of the Auction payment amount

15.27.2 Primary Key Columns

Name

PARTICIPANTID

SRA_QUARTER

SRA_RUNNO

SRA_YEAR

15.27.3 Content

Name	Data Type	Mandatory	Comment
SRA_YEAR	NUMBER(4)	X	Year of the Tranche
SRA_QUARTER	NUMBER(3)	X	Relevant Quarter of the Tranche
SRA_RUNNO	NUMBER(3)	X	SRA Run Number
PARTICIPANTID	VARCHAR2(10)	X	Unique participant identifier
GROSS_PROCEEDS_AMOUNT	NUMBER(18,8)		The total auction proceeds allocated to the TNSP
TOTAL_GROSS_PROCEEDS_AMOUNT	NUMBER(18,8)		The total auction proceeds allocated to all TNSPs in the SRA quarter

SHORTFALL_AMOUNT	NUMBER(18,8)		The shortfall amount for in the SRA Quarter for the TNSP
TOTAL_SHORTFALL_AMOUNT	NUMBER(18,8)		The total shortfall amount for in the SRA Quarter for all TNSPs
NET_PAYMENT_AMOUNT	NUMBER(18,8)		The net payment amount owed by AEMO to the TNSP
LASTCHANGED	DATE		The date and time this record was last modified

15.28 Table: SRA_FINANCIAL_RUNTRK

15.28.1 SRA_FINANCIAL_RUNTRK

Name	SRA_FINANCIAL_RUNTRK
Comment	Records details of the settlement process for the cancellation and purchase of SRA Auction Units

15.28.2 Primary Key Columns

Name
SRA_QUARTER
SRA_RUNNO
SRA_YEAR

15.28.3 Content

Name	Data Type	Mandatory	Comment
SRA_YEAR	NUMBER(4)	X	Year of the Tranche
SRA_QUARTER	NUMBER(3)	X	Relevant Quarter of the Tranche
SRA_RUNNO	NUMBER(3)	X	SRA Run Number
RUNTYPE	VARCHAR2(20)		The type of SRA run
RUNDATE	DATE		The date and time the run was triggered
POSTEDDATE	DATE		The date/time the run was posted
INTEREST_VERSIONNO	NUMBER(3)		Version number of the interest component used in the payments

			run
MAKEUP_VERSIONNO	NUMBER(3)		Version number of the makeup component used in the makeup run
LASTCHANGED	DATE		The date and time this record was last modified

15.29 Table: SRA_OFFER_PRODUCT

15.29.1 SRA_OFFER_PRODUCT

Name	SRA_OFFER_PRODUCT
Comment	Holds the Product details for each Offer File submitted by each SRA Auction Participant.

15.29.2 Primary Key Columns

Name
AUCTIONID
LOADDATE
OPTIONID
PARTICIPANTID

15.29.3 Content

Name	Data Type	Mandatory	Comment
AUCTIONID	VARCHAR2(30)	X	Unique ID for each Auction date
PARTICIPANTID	VARCHAR2(10)	X	Unique participant identifier
LOADDATE	DATE	X	The date and time the system loaded the SRA Offer File
OPTIONID	NUMBER(4)	X	Unique Product identifier (1 - 2000)
INTERCONNECTORID	VARCHAR2(10)		Unique Directional Interconnector identifier

FROMREGIONID	VARCHAR2(10)		The source Region identifier for the Directional Interconnector
OFFER_QUANTITY	NUMBER(5)		The Offer quantity for this Product
OFFER_PRICE	NUMBER(18,8)		The Offer price for this Product
TRANCHEID	VARCHAR2(30)		Tranche identifier
LASTCHANGED	DATE		The date and time this record was last modified

15.30 Table: SRA_OFFER_PROFILE

15.30.1 SRA_OFFER_PROFILE

Name SRA_OFFER_PROFILE

Comment Holds the data of an SRA Auction Participant Offer Submission.

15.30.2 Primary Key Columns

Name

AUCTIONID

LOADDATE

PARTICIPANTID

15.30.3 Content

Name	Data Type	Mandatory	Comment
AUCTIONID	VARCHAR2(30)	X	Unique ID for each Auction date
PARTICIPANTID	VARCHAR2(10)	X	Unique participant identifier
LOADDATE	DATE	X	The date and time the system loaded the SRA Offer File
FILENAME	VARCHAR2(40)		SRA Offer File name
ACKFILENAME	VARCHAR2(40)		SRA acknowledgment file name
TRANSACTIONID	VARCHAR2(100)		Transaction ID used for tracking

LASTCHANGED	DATE		The date and time this record was last modified
-------------	------	--	---

15.31 Table: SRA_PRUDENTIAL_CASH_SECURITY

15.31.1 SRA_PRUDENTIAL_CASH_SECURITY

Name	SRA_PRUDENTIAL_CASH_SECURITY
Comment	Records the Cash Security details provided by an SRA Auction Participant as collateral to cover their Trading Position in the SRA market

15.31.2 Primary Key Columns

Name
CASH_SECURITY_ID
PARTICIPANTID
PRUDENTIAL_DATE
PRUDENTIAL_RUNNO

15.31.3 Content

Name	Data Type	Mandatory	Comment
PRUDENTIAL_DATE	DATE	X	The prudential date of the run.
PRUDENTIAL_RUNNO	NUMBER(8)	X	The run number for the prudential date
PARTICIPANTID	VARCHAR2(10)	X	Unique participant identifier for the Auction Participant lodging the Cash Security
CASH_SECURITY_ID	VARCHAR2(36)	X	Unique identifier for the cash security.
CASH_SECURITY_AMOUNT	NUMBER(18,8)		Remaining Cash Security deposit

			available
--	--	--	-----------

15.32 Table: SRA_PRUDENTIAL_COMP_POSITION

15.32.1 SRA_PRUDENTIAL_COMP_POSITION

Name	SRA_PRUDENTIAL_COMP_POSITION
Comment	The prudential position of each company at the date and time of a specific prudential run

15.32.2 Primary Key Columns

Name
PARTICIPANTID
PRUDENTIAL_DATE
PRUDENTIAL_RUNNO

15.32.3 Content

Name	Data Type	Mandatory	Comment
PRUDENTIAL_DATE	DATE	X	The prudential date of the run.
PRUDENTIAL_RUNNO	NUMBER(8)	X	The run number for the prudential date
PARTICIPANTID	VARCHAR2(10)	X	Unique participant identifier
TRADING_LIMIT	NUMBER(18,8)		The Trading Limit of the company at the time of the prudential run
PRUDENTIAL_EXPOSURE_AMOUNT	NUMBER(18,8)		Current Prudential Exposure of the Auction Participant including Offers
TRADING_MARGIN	NUMBER(18,8)		The amount of Trading Margin available to the Auction Participant

			<p>to trade (including Offered Units and Cancelled Units). Equal to TRADING_LIMIT " PRUDENTIAL_EXPOSURE_AMOUNT.</p>
--	--	--	--

15.33 Table: SRA_PRUDENTIAL_EXPOSURE

15.33.1 SRA_PRUDENTIAL_EXPOSURE

Name	SRA_PRUDENTIAL_EXPOSURE
Comment	Records details of the Prudential Exposure of an SRA Auction Participant

15.33.2 Primary Key Columns

Name

FROMREGIONID

INTERCONNECTORID

PARTICIPANTID

PRUDENTIAL_DATE

PRUDENTIAL_RUNNO

SRA_QUARTER

SRA_YEAR

15.33.3 Content

Name	Data Type	Mandatory	Comment
PRUDENTIAL_DATE	DATE	X	The prudential date of the run.
PRUDENTIAL_RUNNO	NUMBER(8)	X	The run number for the prudential date.
PARTICIPANTID	VARCHAR2(10)	X	Unique participant identifier
SRA_YEAR	NUMBER(4)	X	AEMO Contract Year number

			starting the week beginning 1 January
SRA_QUARTER	NUMBER(3)	X	Contract Relevant Quarter
INTERCONNECTORID	VARCHAR2(10)	X	The identifier for the Directional Interconnector
FROMREGIONID	VARCHAR2(10)	X	The source Region identifier for the Directional Interconnector
MAX_TRANCHE	NUMBER(2)		The largest Tranche where the Unit was either sold or offered. Used in the calculation of the Average Purchase Price for the Trading Position of the Product. The most recent Tranche where Units were cancelled or offered (if the Offer is below the Average Purchase Price)
AUCTIONID	VARCHAR2(30)		Unique identifier for the Auction having the Offer. Has a null value when no Offer is made for the Relevant Quarter
OFFER_SUBMISSIONTIME	DATE		Timestamp of the Offer File submitted by the Auction Participant. Has a null value when no Offer is made for the Relevant Quarter
AVERAGE_PURCHASE_PRICE	NUMBER(18,8)		Calculated Average Purchase Price for the Product
AVERAGE_CANCELLATION_PRICE	NUMBER(18,8)		Calculated average cancellation price for product.
CANCELLATION_VOLUME	NUMBER(18,8)		Calculated cancellation volume for product.
TRADING_POSITION	NUMBER(18,8)		Calculated trading position for product.

15.34 Table: SRA_PRUDENTIAL_RUN

15.34.1 SRA_PRUDENTIAL_RUN

Name SRA_PRUDENTIAL_RUN

Comment Records the prudential run details for each prudential date

15.34.2 Primary Key Columns

Name

PRUDENTIAL_DATE

PRUDENTIAL_RUNNO

15.34.3 Content

Name	Data Type	Mandatory	Comment
PRUDENTIAL_DATE	DATE	X	The prudential date of the run.
PRUDENTIAL_RUNNO	NUMBER(8)	X	The prudential run number for the run

15.35 Table: VALUATIONID

15.35.1 VALUATIONID

Name	VALUATIONID
Comment	VALUATIONID shows the identifiers and descriptions of the valuers submitting estimates of upcoming settlement residues. VALUATIONID supports the Settlement Residue Auction.

15.35.2 Description

VALUATIONID is public data, and is available to all participants.

Source

VALUATIONID updates are quarterly from the Settlement Residues Information System [SRIS].

Volume

VALUATIONID shows up to five (5) records. Updates are rare.

15.35.3 Notes

Name	Comment	Value
Visibility	Data in this table is:	Public

15.35.4 Primary Key Columns

Name
VALUATIONID

15.35.5 Index Columns

Name
LASTCHANGED

15.35.6 Content

Name	Data Type	Mandatory	Comment
VALUATIONID	VARCHAR2(15)	X	Identifier of the estimator
DESCRIPTION	VARCHAR2(80)		Full name of estimator
LASTCHANGED	DATE		Timestamp of record creation or modification

16 Package: MARKET_CONFIG

<i>Name</i>	MARKET_CONFIG
<i>Comment</i>	Standing data for the market

16.1 List of tables

Name	Comment
BIDTYPES	<p>BIDTYPES, together with the associated tracking data in BIDTYPESTRK, define a set of ancillary services with bidding parameters from a given date.</p> <p>BIDTYPES is static data describing each type of bid quantity, the number of applicable bands, how many days ahead a price lock down becomes effective and the validation rule that applies.</p>
BIDTYPESTRK	<p>BIDTYPESTRK, together with the associated data in BIDTYPES, define a set of ancillary services with bidding parameters from a given date.</p>
INTERCONNECTOR	<p>INTERCONNECTOR sets out valid identifiers for each interconnector.</p>
INTERCONNECTORALLOC	<p>INTERCONNECTORALLOC shows allocations of interconnector residues to Network Service Providers.</p>
INTERCONNECTORCONSTRAINT	<p>INTERCONNECTORCONSTRAINT sets out Interconnector limit data used as defaults in dispatch, pre-dispatch and STPASA and used by SPD in calculating flows.</p> <p>INTERCONNECTORCONSTRAINT includes an additional field to restrict an interconnector from support transfer of FCAS.</p>
INTRAREGIONALALLOC	<p>INTRAREGIONALALLOC shows allocations of intra-regional residues to participants.</p>

LOSSFACTORMODEL	LOSSFACTORMODEL sets out the demand coefficients for each interconnector, used by LP Solver modelling of interconnector flows.
LOSSMODEL	LOSSMODEL sets out segment breakpoints in loss model for each interconnector, used by LP Solver modelling of interconnector flows.
MARKET_PRICE_THRESHOLDS	MARKET_PRICE_THRESHOLDS sets out the market cap , floor and administered price thresholds applying to the electricity market
REGION	REGION sets out valid region IDs.
REGIONSTANDINGDATA	REGIONSTANDINGDATA sets out standing region data including the region reference node.
TRANSMISSIONLOSSFACTOR	TRANSMISSIONLOSSFACTOR shows the Transmission Loss factors applied at each connection point.

16.2 Diagram: Entities: Market Standing Data

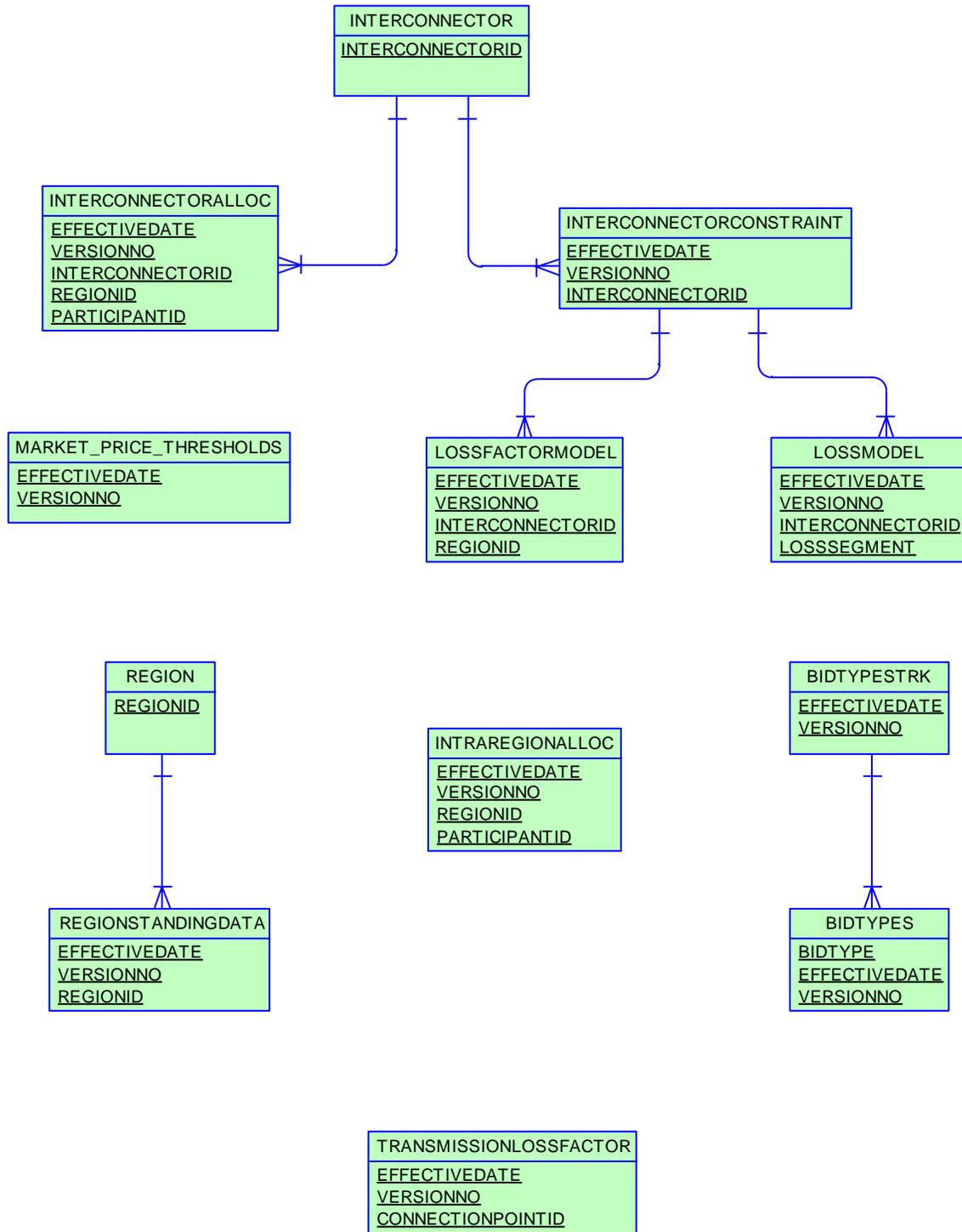

16.3 Table: BIDTYPES

16.3.1 BIDTYPES

Name	BIDTYPES
Comment	<p>BIDTYPES, together with the associated tracking data in BIDTYPESTRK, define a set of ancillary services with bidding parameters from a given date.</p> <p>BIDTYPES is static data describing each type of bid quantity, the number of applicable bands, how many days ahead a price lock down becomes effective and the validation rule that applies.</p>

16.3.2 Description

BIDTYPES is public to participants

Source

BIDTYPES updates when the static data relating to an ancillary service type is modified.

Volume

Expect modifications to be rare. Allow for approximately 20 records per year.

16.3.3 Notes

Name	Comment	Value
Visibility	Data in this table is:	Public

16.3.4 Primary Key Columns

- Name
- BIDTYPE
- EFFECTIVEDATE
- VERSIONNO

16.3.5 Index Columns

Name

LASTCHANGED

16.3.6 Content

Name	Data Type	Mandatory	Comment
BIDTYPE	VARCHAR2(10)	X	Bid Type Identifier
EFFECTIVEDATE	DATE	X	Market date starting at 04:30 inclusive
VERSIONNO	NUMBER(3,0)	X	Record version number
DESCRIPTION	VARCHAR2(64)		Description of this Bid Type
NUMBEROFBANDS	NUMBER(3,0)		Number of active bands (1 to 10)
NUMDAYSAHEADPRICELOCKED	NUMBER(2,0)		Number of days prior to the Market Day when prices are locked from 12:30pm
VALIDATIONRULE	VARCHAR2(10)		ENERGY or AS validation rules to apply.
LASTCHANGED	DATE		Last date and time record changed
SPDALIAS	VARCHAR2(10)		Alias for this BIDTYPE used in the SPD Solver

16.4 Table: BIDTYPESTRK

16.4.1 BIDTYPESTRK

Name	BIDTYPESTRK
Comment	BIDTYPESTRK, together with the associated data in BIDTYPES, define a set of ancillary services with bidding parameters from a given date.

16.4.2 Description

BIDTYPESTRK is public to participants

Source

BIDTYPESTRK updates when the static data relating to an ancillary service type is modified.

Volume

Expect modifications to be rare. Allow for approximately 20 records per year.

16.4.3 Notes

Name	Comment	Value
Visibility	Data in this table is:	Public

16.4.4 Primary Key Columns

Name
EFFECTIVEDATE
VERSIONNO

16.4.5 Index Columns

Name
LASTCHANGED

16.4.6 Content

Name	Data Type	Mandatory	Comment
EFFECTIVEDATE	DATE	X	Market date starting at 04:30 inclusive
VERSIONNO	NUMBER(3,0)	X	Record version number
AUTHORISEDDATE	DATE		Date of record authorisation. A NULL value indicates the record is not authorised.
AUTHORISEDBY	VARCHAR2(15)		User that authorised record. A NULL value indicates the record is not authorised.
LASTCHANGED	DATE		Last date and time record changed

16.5 Table: INTERCONNECTOR

16.5.1 INTERCONNECTOR

Name INTERCONNECTOR

Comment INTERCONNECTOR sets out valid identifiers for each interconnector.

16.5.2 Description

INTERCONNECTOR is public data, available to all participants.

Source

INTERCONNECTOR changes infrequently, usually annually.

16.5.3 Notes

Name	Comment	Value
Visibility	Data in this table is:	Public

16.5.4 Primary Key Columns

Name

INTERCONNECTORID

16.5.5 Index Columns

Name

LASTCHANGED

16.5.6 Content

Name	Data Type	Manda	Comment
------	-----------	-------	---------

		tory	
INTERCONNECTORID	VARCHAR2(10)	X	Unique Id of this interconnector
REGIONFROM	VARCHAR2(10)		Starting region of the interconnect
RSOID	VARCHAR2(10)		Not used
REGIONTO	VARCHAR2(10)		Ending region of the interconnect
DESCRIPTION	VARCHAR2(64)		Description of interconnector
LASTCHANGED	DATE		Last date and time record changed

16.6 Table: INTERCONNECTORALLOC

16.6.1 INTERCONNECTORALLOC

Name	INTERCONNECTORALLOC
Comment	INTERCONNECTORALLOC shows allocations of interconnector residues to Network Service Providers.

16.6.2 Description

INTERCONNECTORALLOC data is confidential to the relevant participant.

Source

INTERCONNECTORALLOC changes infrequently, typically annually.

16.6.3 Notes

Name	Comment	Value
Visibility	Data in this table is:	Private

16.6.4 Primary Key Columns

- Name
- EFFECTIVEDATE
- INTERCONNECTORID
- PARTICIPANTID
- REGIONID
- VERSIONNO

16.6.5 Index Columns

Name

LASTCHANGED

16.6.6 Content

Name	Data Type	Mandatory	Comment
EFFECTIVEDATE	DATE	X	Effective Date of Allocation Details
VERSIONNO	NUMBER(5,0)	X	Version No in respect to effective date
INTERCONNECTORID	VARCHAR2(10)	X	Interconnector identifier
REGIONID	VARCHAR2(10)	X	Region Identifier
PARTICIPANTID	VARCHAR2(10)	X	Unique participant identifier
ALLOCATION	NUMBER(12,5)		Allocation % / 100
LASTCHANGED	DATE		Last date and time record changed

16.7 Table: INTERCONNECTORCONSTRAINT

16.7.1 INTERCONNECTORCONSTRAINT

Name	INTERCONNECTORCONSTRAINT
Comment	INTERCONNECTORCONSTRAINT sets out Interconnector limit data used as defaults in dispatch, predispatch and STPASA and used by SPD in calculating flows. INTERCONNECTORCONSTRAINT includes an additional field to restrict an interconnector from support transfer of FCAS.

16.7.2 Description

INTERCONNECTORCONSTRAINT is public data, available to all participants.

Source

INTERCONNECTORCONSTRAINT changes infrequently, typically annually.

16.7.3 Notes

Name	Comment	Value
Visibility	Data in this table is:	Public

16.7.4 Primary Key Columns

- Name
- EFFECTIVEDATE
- INTERCONNECTORID
- VERSIONNO

16.7.5 Index Columns

- Name

LASTCHANGED

16.7.6 Content

Name	Data Type	Mandatory	Comment
RESERVEOVERALLLOADFACTOR	NUMBER(5,2)		SPD Factor
FROMREGIONLOSSSHARE	NUMBER(5,2)		Loss share attributable to from region
EFFECTIVEDATE	DATE	X	Date that this limit is effective from
VERSIONNO	NUMBER(3,0)	X	Version for this date
INTERCONNECTORID	VARCHAR2(10)	X	Unique Id of this interconnector
MAXMWIN	NUMBER(15,5)		Limit of energy flowing into the RegionFrom
MAXMWOUT	NUMBER(15,5)		Limit of energy flowing out of the Region
LOSSCONSTANT	NUMBER(15,6)		Constant Loss factor
LOSSFLOWCOEFFICIENT	NUMBER(27,17)		Linear coefficient of loss factor calculation
EMSMEASURAND	VARCHAR2(40)		Identifies the EMS entity that represents the interconnector flow
AUTHORISED BY	VARCHAR2(15)		User authorising record
AUTHORISED DATE	DATE		Date record authorised
DYNAMICRHS	VARCHAR2(1)		Not used

IMPORTLIMIT	NUMBER(6,0)		Interconnector import limit
EXPORTLIMIT	NUMBER(6,0)		Interconnector export limit
OUTAGEDERATIONFACTOR	NUMBER(15,5)		SPD Factor
NONPHYSICALLOSSFACTOR	NUMBER(15,5)		Factor for non-physical losses rerun
OVERLOADFACTOR60SEC	NUMBER(15,5)		Interconnector overload for 60 sec
OVERLOADFACTOR6SEC	NUMBER(15,5)		Interconnector overload for 6 sec
LASTCHANGED	DATE		Last date and time record changed
FCASSUPPORTUNAVAILABLE	NUMBER(1,0)		Flag to indicate that the interconnector cannot support FCAS Transfers
ICTYPE	VARCHAR2(10)		Interconnector type - Currently either "REGULATED" or "MNSP"

16.8 Table: INTRAREGIONALLOC

16.8.1 INTRAREGIONALLOC

Name	INTRAREGIONALLOC
Comment	INTRAREGIONALLOC shows allocations of intra-regional residues to participants.

16.8.2 Description

INTRAREGIONALLOC data is confidential to the relevant participant.

Source

The data in INTRAREGIONALLOC changes infrequently.

16.8.3 Notes

Name	Comment	Value
Visibility	Data in this table is:	Private

16.8.4 Primary Key Columns

Name

EFFECTIVEDATE

PARTICIPANTID

REGIONID

VERSIONNO

16.8.5 Index Columns

Name

LASTCHANGED

16.8.6 Content

Name	Data Type	Mandatory	Comment
EFFECTIVEDATE	DATE	X	Effective Date of Allocation Details
VERSIONNO	NUMBER(5,0)	X	Version No in respect to effective date
REGIONID	VARCHAR2(10)	X	Region Identifier
PARTICIPANTID	VARCHAR2(10)	X	Unique participant identifier
ALLOCATION	NUMBER(12,5)		Allocation Percent / 100
LASTCHANGED	DATE		Last changed date/time

16.9 Table: LOSSFACTORMODEL

16.9.1 LOSSFACTORMODEL

Name	LOSSFACTORMODEL
Comment	LOSSFACTORMODEL sets out the demand coefficients for each interconnector, used by LP Solver modelling of interconnector flows.

16.9.2 Description

LOSSFACTORMODEL is public data, so is available to all participants.

Source

LOSSFACTORMODEL only changes annually, when there is a change in the interconnector.

16.9.3 Notes

Name	Comment	Value
Visibility	Data in this table is:	Public

16.9.4 Primary Key Columns

- Name
- EFFECTIVEDATE
- INTERCONNECTORID
- REGIONID
- VERSIONNO

16.9.5 Index Columns

- Name

LASTCHANGED

16.9.6 Content

Name	Data Type	Mandatory	Comment
EFFECTIVEDATE	DATE	X	Calendar date data set is effective
VERSIONNO	NUMBER(3,0)	X	Version number within effective date of the status proposed
INTERCONNECTORID	VARCHAR2(10)	X	The unique identifier for the interconnector.
REGIONID	VARCHAR2(10)	X	The unique region identifier for a connection point of the interconnector
DEMANDCOEFFICIENT	NUMBER(27,17)		The coefficient applied to the region demand in the calculation of the interconnector loss factor
LASTCHANGED	DATE		Last date and time record changed

16.10 Table: LOSSMODEL

16.10.1 LOSSMODEL

Name	LOSSMODEL
Comment	LOSSMODEL sets out segment breakpoints in loss model for each interconnector, used by LP Solver modelling of interconnector flows.

16.10.2 Description

LOSSMODEL data is public, so is available to all participants.

Source

LOSSMODEL only changes annually, when there is a change in the interconnector.

16.10.3 Notes

Name	Comment	Value
Visibility	Data in this table is:	Public

16.10.4 Primary Key Columns

Name

EFFECTIVEDATE

INTERCONNECTORID

LOSSSEGMENT

VERSIONNO

16.10.5 Index Columns

Name

LASTCHANGED

16.10.6 Content

Name	Data Type	Mandatory	Comment
EFFECTIVEDATE	DATE	X	Calendar date data set is effective
VERSIONNO	NUMBER(3,0)	X	Version number within effective date
INTERCONNECTORID	VARCHAR2(10)	X	Interconnector identifier
PERIODID	VARCHAR2(20)		Not used
LOSSSEGMENT	NUMBER(6,0)	X	Segment Identifier (1 to 80 at present)
MWBREAKPOINT	NUMBER(6,0)		MW Value for segment
LOSSFACTOR	NUMBER(16,6)		Not used
LASTCHANGED	DATE		Last date and time record changed

16.11 Table: MARKET_PRICE_THRESHOLDS

16.11.1 MARKET_PRICE_THRESHOLDS

Name	MARKET_PRICE_THRESHOLDS
Comment	MARKET_PRICE_THRESHOLDS sets out the market cap , floor and administered price thresholds applying to the electricity market

16.11.2 Description

MARKET_PRICE_THRESHOLDS data is public, so is available to all participants.

Source

MARKET_PRICE_THRESHOLDS only changes when a change is made to a market price threshold. This table changes infrequently.

16.11.3 Notes

Name	Comment	Value
Visibility	Data in this table is:	Public

16.11.4 Primary Key Columns

- Name
- EFFECTIVEDATE
- VERSIONNO

16.11.5 Index Columns

- Name
- LASTCHANGED

16.11.6 Content

Name	Data Type	Mandatory	Comment
EFFECTIVEDATE	DATE	X	Calendar date that this record becomes effective
VERSIONNO	NUMBER(4,0)	X	version no for the effective date
VOLL	NUMBER(15,5)		value of lost load if total supply falls short of demand after load management then involuntary load
MARKETPRICEFLOOR	NUMBER(15,5)		The floor price that the spot market price will not fall below.
ADMINISTERED_PRICE_THRESHOLD	NUMBER(15,5)		Threshold value beyond which Aggregate Prices per Region over 336 Trade Intervals (Energy), or 2016 Dispatch Intervals (FCAS), will result in an Administered Price declaration
AUTHORISEDDATE	DATE		date data authorised
AUTHORISEDBY	VARCHAR2(15)		user authorising
LASTCHANGED	DATE		Last date and time record changed

16.12 Table: REGION

16.12.1 REGION

Name REGION
Comment REGION sets out valid region IDs.

16.12.2 Description

REGION data is public, so is available to all participants.

Source

REGION updates if a change is ever made to a region. This table is static data and is likely to change very infrequently.

16.12.3 Notes

Name	Comment	Value
Visibility	Data in this table is:	Public

16.12.4 Primary Key Columns

Name
REGIONID

16.12.5 Index Columns

Name
LASTCHANGED

16.12.6 Content

Name	Data Type	Mandatory	Comment
------	-----------	-----------	---------

REGIONID	VARCHAR2(10)	X	Differentiates this region from all other regions
DESCRIPTION	VARCHAR2(64)		Full description of region
REGIONSTATUS	VARCHAR2(8)		Status of the region e.g. working, inactive, archive.
LASTCHANGED	DATE		Last date and time record changed

16.13 Table: REGIONSTANDINGDATA

16.13.1 REGIONSTANDINGDATA

Name	REGIONSTANDINGDATA
Comment	REGIONSTANDINGDATA sets out standing region data including the region reference node.

16.13.2 Description

REGIONSTANDINGDATA data is public, so is available to all participants.

Source

REGIONSTANDINGDATA only changes when a change is made to a region. This table changes infrequently.

16.13.3 Notes

Name	Comment	Value
Visibility	Data in this table is:	Public

16.13.4 Primary Key Columns

- Name
- EFFECTIVEDATE
- REGIONID
- VERSIONNO

16.13.5 Index Columns

- Name
- LASTCHANGED

16.13.6 Content

Name	Data Type	Mandatory	Comment
EFFECTIVEDATE	DATE	X	Effective date of this record, only the latest date applies
VERSIONNO	NUMBER(3,0)	X	Version No of the standing data that should be effective on this date
REGIONID	VARCHAR2(10)	X	Differentiates this region from all other regions
RSOID	VARCHAR2(10)		the unique identifier of the participant with responsibility for the region.
REGIONALREFERENCEPOINTID	VARCHAR2(10)		unique id of a connection point, being the reference point for this region
PEAKTRADINGPERIOD	NUMBER(3,0)		Period identifier of the peak trading period of this connection point
AUTHORISEDDATE	DATE		Date record authorised
AUTHORISEDBY	VARCHAR2(15)		User authorising record
SCALINGFACTOR	NUMBER(15,5)		Scaling factor for regional FCAS requirement
LASTCHANGED	DATE		Last date and time record changed

16.14 Table: TRANSMISSIONLOSSFACTOR

16.14.1 TRANSMISSIONLOSSFACTOR

Name	TRANSMISSIONLOSSFACTOR
Comment	TRANSMISSIONLOSSFACTOR shows the Transmission Loss factors applied at each connection point.

16.14.2 Description

TRANSMISSIONLOSSFACTOR is public data, and is available to all participants.

Source

TRANSMISSIONLOSSFACTOR updates when new connection points are created or loss factors change.

16.14.3 Notes

Name	Comment	Value
Visibility	Data in this table is:	Public

16.14.4 Primary Key Columns

- Name
- CONNECTIONPOINTID
- EFFECTIVEDATE
- VERSIONNO

16.14.5 Index Columns

- Name
- LASTCHANGED

16.14.6 Content

Name	Data Type	Mandatory	Comment
TRANSMISSIONLOSSFACTOR	NUMBER(15,5)	X	Transmission Loss Factor
EFFECTIVEDATE	DATE	X	Effective date of record
VERSIONNO	NUMBER(22,0)	X	Version no of record for given effective date
CONNECTIONPOINTID	VARCHAR2(10)	X	Connection Point ID
REGIONID	VARCHAR2(10)		
LASTCHANGED	DATE		Record creation timestamp
SECONDARY_TLF	NUMBER(18,8)		Secondary transmission loss factor applied in settlements for generator purchases.

17 Package: MARKET_NOTICE

Name MARKET_NOTICE
Comment Market Notice data

17.1 List of tables

Name	Comment
MARKETNOTICEDATA	MARKETNOTICEDATA shows market notices data provided to all participants (market) and specific participants (participant).
MARKETNOTICETYPE	MARKETNOTICETYPE sets out the different types of market notices (e.g. market systems).
PARTICIPANTNOTICETRK	PARTICIPANTNOTICETRK provides the cross-reference between participant market notices and participants.

17.2 Diagram: Entities: Market Notices

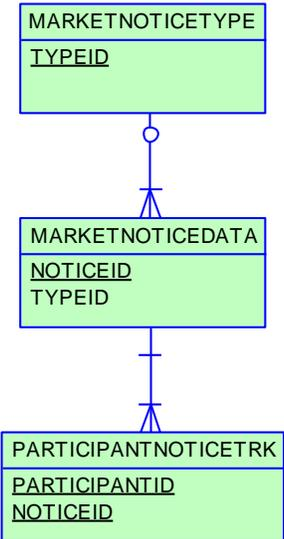

17.3 Table: MARKETNOTICEDATA

17.3.1 MARKETNOTICEDATA

Name	MARKETNOTICEDATA
Comment	MARKETNOTICEDATA shows market notices data provided to all participants (market) and specific participants (participant).

17.3.2 Description

MARKETNOTICEDATA data is confidential to each participant, although some notices are sent to all participants.

Source

MARKETNOTICEDATA updates immediately available.

17.3.3 Notes

Name	Comment	Value
Visibility	Data in this table is:	Private & Public

17.3.4 Primary Key Columns

Name
NOTICEID

17.3.5 Index Columns

Name
LASTCHANGED

17.3.6 Content

Name	Data Type	Manda	Comment
------	-----------	-------	---------

		tory	
NOTICEID	NUMBER(10,0)	X	Notice Identifier
EFFECTIVEDATE	DATE		Effective Date of Market notice
TYPEID	VARCHAR2(25)		Market Notice Type Identifier (Market - all participants. Participant - selected participants)
NOTICETYPE	VARCHAR2(25)		Market Notice Type
LASTCHANGED	DATE		Last date and time record changed
REASON	VARCHAR2(20 00)		Detail of market notices.
EXTERNALREFERENCE	VARCHAR2(25 5)		External Reference for extra data pertaining to market notice

17.4 Table: MARKETNOTICETYPE

17.4.1 MARKETNOTICETYPE

Name	MARKETNOTICETYPE
Comment	MARKETNOTICETYPE sets out the different types of market notices (e.g. market systems).

17.4.2 Description

MARKETNOTICETYPE data is public, so is available to all participants.

Source

MARKETNOTICETYPE updates whenever market notice types change.

17.4.3 Notes

Name	Comment	Value
Visibility	Data in this table is:	Public

17.4.4 Primary Key Columns

Name
TYPEID

17.4.5 Index Columns

Name
LASTCHANGED

17.4.6 Content

Name	Data Type	Mandatory	Comment

TYPEID	VARCHAR2(25)	X	Identifier for market notice type
DESCRIPTION	VARCHAR2(64)		Type description
RAISED BY	VARCHAR2(10)		Not used
LASTCHANGED	DATE		Last date and time record changed

17.5 Table: PARTICIPANTNOTICETRK

17.5.1 PARTICIPANTNOTICETRK

Name	PARTICIPANTNOTICETRK
Comment	PARTICIPANTNOTICETRK provides the cross-reference between participant market notices and participants.

17.5.2 Description

PARTICIPANTNOTICETRK data is Confidential to the relevant participant.

Source

PARTICIPANTNOTICETRK updates immediately, whenever a participant notice is issued.

17.5.3 Notes

Name	Comment	Value
Visibility	Data in this table is:	Private

17.5.4 Primary Key Columns

Name
 NOTICEID
 PARTICIPANTID

17.5.5 Index Columns

Name
 LASTCHANGED

17.5.6 Index Columns

Name

PARTICIPANTID

17.5.7 Content

Name	Data Type	Mandatory	Comment
PARTICIPANTID	VARCHAR2(10)	X	Unique participant identifier
NOTICEID	NUMBER(10,0)	X	Market notice identifier
LASTCHANGED	DATE		Last date and time record changed

18 Package: METER_DATA

<i>Name</i>	METER_DATA
<i>Comment</i>	Wholesale market aggregated Meter data

18.1 List of tables

Name	Comment
METERDATA_AGGREGATE_READS	Publishes aggregated metering data associated with a wholesale connection point for a given CASE_ID
METERDATA_INDIVIDUAL_READS	Publishes metering data associated with individual metering points for a given CASE_ID
METERDATA_INTERCONNECTOR	Publishes metering data associated with wholesale interconnectors for a given CASE_ID
METERDATA_TRK	Tracking table for the publication of wholesale settlement data associated with BILLING run

18.2 Diagram: Entities: Meter Data

Note: Include MDA = MeteringDataAgent in any join

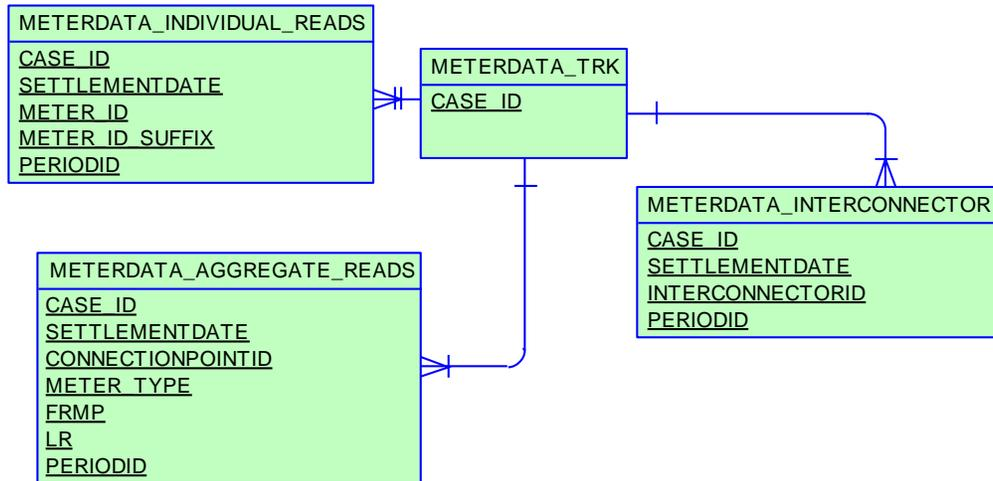

18.3 Table: METERDATA_AGGREGATE_READS

18.3.1 METERDATA_AGGREGATE_READS

Name	METERDATA_AGGREGATE_READS
Comment	Publishes aggregated metering data associated with a wholesale connection point for a given CASE_ID

18.3.2 Notes

Name	Comment	Value
Visibility	Data in this table is:	Private

18.3.3 Primary Key Columns

- Name
- CASE_ID
- CONNECTIONPOINTID
- FRMP
- LR
- METER_TYPE
- PERIODID
- SETTLEMENTDATE

18.3.4 Index Columns

- Name
- CASE_ID

SETTLEMENTDATE

CONNECTIONPOINTID

METER_TYPE

FRMP

LR

PERIODID

18.3.5 Content

Name	Data Type	Mandatory	Comment
CASE_ID	NUMBER(15,0)	X	Case Identifier
SETTLEMENTDATE	DATE	X	Settlement date within the case
CONNECTIONPOINTID	VARCHAR2(20)	X	Connection Point ID
METER_TYPE	VARCHAR2(20)	X	The meter type for the read, one of: CUSTOMER; GENERATOR; EMBEDDED_GENERATOR
FRMP	VARCHAR2(20)	X	The financially responsible market participantid
LR	VARCHAR2(20)	X	The local retailer at the connection point id
PERIODID	NUMBER(3,0)	X	The settlement interval identifier
IMPORTVALUE	NUMBER(18,8)	X	The import(pool-centric) value for the meter read (MWh)
EXPORTVALUE	NUMBER(18,8)	X	The export(pool-centric) value for the meter read (MWh)

LASTCHANGED	DATE		Last changed date for the record
-------------	------	--	----------------------------------

18.4 Table: METERDATA_INDIVIDUAL_READS

18.4.1 METERDATA_INDIVIDUAL_READS

Name	METERDATA_INDIVIDUAL_READS
Comment	Publishes metering data associated with individual metering points for a given CASE_ID

18.4.2 Notes

Name	Comment	Value
Visibility	Data in this table is:	Private

18.4.3 Primary Key Columns

- Name
- CASE_ID
- METER_ID
- METER_ID_SUFFIX
- PERIODID
- SETTLEMENTDATE

18.4.4 Index Columns

- Name
- CASE_ID
- SETTLEMENTDATE
- METER_ID
- METER_ID_SUFFIX

PERIODID

18.4.5 Content

Name	Data Type	Mandatory	Comment
CASE_ID	NUMBER(15,0)	X	Case Identifier
SETTLEMENTDATE	DATE	X	Settlement date within the case
METER_ID	VARCHAR2(20)	X	The National Metering Identifier (NMI)
METER_ID_SUFFIX	VARCHAR2(20)	X	The National Metering Identifier (NMI) data stream
FRMP	VARCHAR2(20)	X	The financially responsible market participantid
LR	VARCHAR2(20)	X	The local retailer at the connection point id
PERIODID	NUMBER(3,0)	X	The settlement interval identifier
CONNECTIONPOINTID	VARCHAR2(20)	X	Connection Point ID
METER_TYPE	VARCHAR2(20)	X	The meter type for the read, one of: CUSTOMER; GENERATOR; EMBEDDED_GENERATOR
IMPORTVALUE	NUMBER(18,8)	X	The import(pool-centric) value for the meter read (MWh)
EXPORTVALUE	NUMBER(18,8)	X	The export(pool-centric) value for the meter read (MWh)
LASTCHANGED	DATE		Last changed date for the record

18.5 Table: METERDATA_INTERCONNECTOR

18.5.1 METERDATA_INTERCONNECTOR

Name	METERDATA_INTERCONNECTOR
Comment	Publishes metering data associated with wholesale interconnectors for a given CASE_ID

18.5.2 Notes

Name	Comment	Value
Visibility	Data in this table is:	Public

18.5.3 Primary Key Columns

- Name
- CASE_ID
- INTERCONNECTORID
- PERIODID
- SETTLEMENTDATE

18.5.4 Index Columns

- Name
- CASE_ID
- SETTLEMENTDATE
- INTERCONNECTORID
- PERIODID

18.5.5 Content

Name	Data Type	Mandatory	Comment
CASE_ID	NUMBER(15,0)	X	Case Identifier
SETTLEMENTDATE	DATE	X	Settlement date within the case
INTERCONNECTORID	VARCHAR2(20)	X	Interconnector Identifier
PERIODID	NUMBER(3,0)	X	The settlement interval identifier
IMPORTVALUE	NUMBER(18,8)		The import direction value for the meter read (MWh)
EXPORTVALUE	NUMBER(18,8)		The export direction value for the meter read (MWh)
LASTCHANGED	DATE		Last changed date for the record

18.6 Table: METERDATA_TRK

18.6.1 METERDATA_TRK

Name	METERDATA_TRK
Comment	Tracking table for the publication of wholesale settlement data associated with BILLING run

18.6.2 Notes

Name	Comment	Value
Visibility	Data in this table is:	Public

18.6.3 Primary Key Columns

Name
CASE_ID

18.6.4 Index Columns

Name
CASE_ID

18.6.5 Content

Name	Data Type	Mandatory	Comment
CASE_ID	NUMBER(15,0)	X	Case Identifier
AGGREGATE_READS_LOAD_DATETIME	DATE		Timestamp of the aggregated reads being loaded for this case
INDIVIDUAL_READS_LOAD	DATE		Timestamp of the non aggregated

_DATETIME			reads being loaded for this case
STARTDATE	DATE		The start date of data associated with the CASE_ID
ENDDATE	DATE		The end date of data associated with the Case_ID
LASTCHANGED	DATE		Last changed date for the record

19 Package: MREVENT

<i>Name</i>	MREVENT
<i>Comment</i>	Mandatory Restrictions Event data

19.1 List of tables

Name	Comment
MR_DAYOFFER_STACK	MR_DAYOFFER_STACK defines the Stack order for each version of the Acceptance Schedule, including all units submitting MR offers for that event. MR_DAYOFFER_STACK is the child to MR_EVENT_SCHEDULE, and parent to MR_PEROFFER_STACK.
MR_EVENT	MR_EVENT defines an MR Event for a given region on a specific trading date.
MR_EVENT_SCHEDULE	MR_EVENT_SCHEDULE defines the Stack version of the Acceptance Schedule and is the parent table to MR_DayOffer_Stack and MR_PerOffer_Stack.
MR_PEROFFER_STACK	MR_PEROFFER_STACK defines the accepted capacity on a period basis for the Acceptance Schedule, is a child table to MR_DayOffer_Stack and only includes records or units with accepted_capacity > 0 for the specific period.

19.2 Diagram: Entities: MR Events

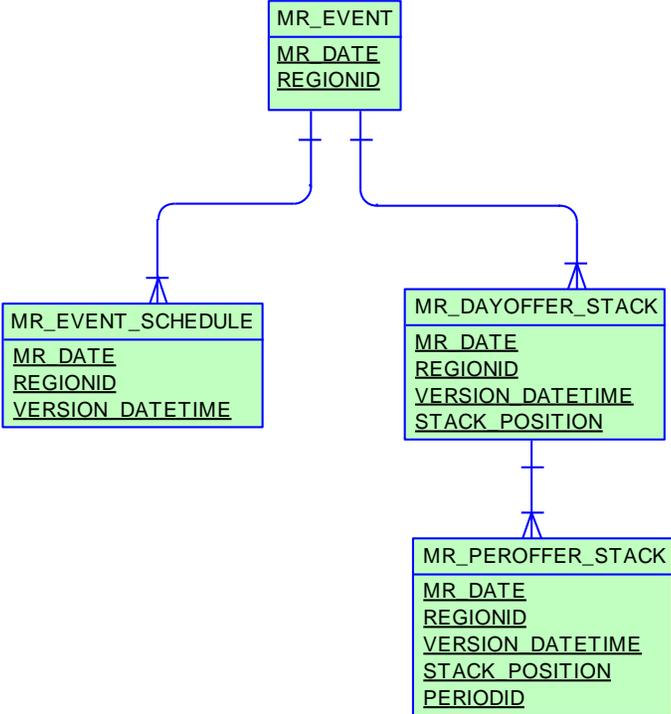

19.3 Table: MR_DAYOFFER_STACK

19.3.1 MR_DAYOFFER_STACK

Name	MR_DAYOFFER_STACK
Comment	MR_DAYOFFER_STACK defines the Stack order for each version of the Acceptance Schedule, including all units submitting MR offers for that event. MR_DAYOFFER_STACK is the child to MR_EVENT_SCHEDULE, and parent to MR_PEROFFER_STACK.

19.3.2 Description

Once the offer cut off time has passed and as the schedule changes AEMO is obliged to accept MR capacity to meet the schedule in merit order according to the offers submitted. The relationship to a specific schedule, the merit order of submitted offers and accepted quantities for each trading interval are stored in the MR_EVENT_SCHEDULE, MR_DAYOFFER_STACK and MR_PEROFFER_STACK.

MR_DAYOFFER_STACK sets includes all generators/MNSPs in the region that submitted an MR offer and a primary key reference to the Offer tables to identify the specific offer used for that unit. MR_DAYOFFER_STACK also includes a Stack Order, irrespective of whether the unit is required to meet the Schedule.

MR_DAYOFFER_STACK updates are confidential on day of submission, with public exposure the next day.

Source

MR_DAYOFFER_STACK updates are ad hoc.

Volume

100 rows per year

19.3.3 Notes

Name	Comment	Value
Visibility	Data in this table is:	Private; Public Next-Day

19.3.4 Primary Key Columns

Name
MR_DATE

REGIONID

STACK_POSITION

VERSION_DATETIME

19.3.5 Index Columns

Name

LASTCHANGED

19.3.6 Content

Name	Data Type	Mandatory	Comment
MR_DATE	DATE	X	Mandatory Restriction imposition date
REGIONID	VARCHAR2(10)	X	Unique RegionID
VERSION_DATETIME	DATE	X	Allows many Stack versions
STACK_POSITION	NUMBER(3,0)	X	Loss Adjusted Offer Factor Stack order starting at 1
DUID	VARCHAR2(10)		Dispatchable Unit ID or LinkID
AUTHORISED	NUMBER(1,0)		Confirms the unit is allowed to Contribute MR Capacity
OFFER_SETTLEMENTDATE	DATE		Foreign key reference to XXXX_DayOffer.SettlementDate
OFFER_OFFERDATE	DATE		Foreign key reference to XXXX_DayOffer.OfferDate

OFFER_VERSIONNO	NUMBER(3,0)		Foreign key reference to XXXX_DayOffer.VersionNo
OFFER_TYPE	VARCHAR2(20)		Source tables - ENERGY or MNSP
LAOF	NUMBER(16,6)		Loss Adjusted Offer Factor = TLF times MR_Factor
LASTCHANGED	DATE		Date and time the record was last inserted/modified

19.4 Table: MR_EVENT

19.4.1 MR_EVENT

Name	MR_EVENT
Comment	MR_EVENT defines an MR Event for a given region on a specific trading date.

19.4.2 Description

MR_EVENT defines a mandatory restriction event for a given region and trading date (04:30 to 04:00). Data within MR_EVENT includes the cut-off time for submission of MR offers for this event and a notification that the settlements figures are locked due to results from an independent expert being engaged to allocate settlement of a significant shortfall. If mandatory restrictions are defined in two regions on the same trading day, two MR events are defined.

MR_EVENT data is public, so is available to all participants.

Source

MR_EVENT updates are ad hoc.

Volume

1 Row per year

19.4.3 Notes

Name	Comment	Value
Visibility	Data in this table is:	Public

19.4.4 Primary Key Columns

- Name
- MR_DATE
- REGIONID

19.4.5 Index Columns

Name

LASTCHANGED

19.4.6 Content

Name	Data Type	Mandatory	Comment
MR_DATE	DATE	X	Mandatory Restriction imposition date
REGIONID	VARCHAR2(10)	X	Unique RegionID
DESCRIPTION	VARCHAR2(200)		Description of MR
AUTHORISEDDATE	DATE		Required for MR_Event to take effect
AUTHORISEDBY	VARCHAR2(20)		Ignored - Tracking purpose only
OFFER_CUT_OFF_TIME	DATE		Cut off after when new Offers and Scaling Factor changes are disallowed
SETTLEMENT_COMPLETE	NUMBER(1,0)		Flag:1 = MR settlement figures locked. Do not recalculate, 0 = MR settlements to be recalculated
LASTCHANGED	DATE		Date/Time record inserted/modified

19.5 Table: MR_EVENT_SCHEDULE

19.5.1 MR_EVENT_SCHEDULE

Name	MR_EVENT_SCHEDULE
Comment	MR_EVENT_SCHEDULE defines the Stack version of the Acceptance Schedule and is the parent table to MR_DayOffer_Stack and MR_PerOffer_Stack.

19.5.2 Description

Once the offer cut off time has passed and as the schedule changes AEMO is obliged to accept MR capacity to meet the schedule in merit order according to the offers submitted. The relationship to a specific schedule, the merit order of submitted offers and accepted quantities for each trading interval are stored in the MR_Event_Schedule, MR_DayOffer_Stack and MR_PerOffer_Stack table.

The MR_EVENT_SCHEDULE table determines the existence of an MR offer acceptance stack for a specific MR schedule of an MR event. The MR_EVENT_SCHEDULE table also tracks the time each stack is exercised. MR_EVENT_SCHEDULE is public and notifies the market that a new offer stack has been created.

Source

MR_EVENT_SCHEDULE updates are ad hoc.

Volume

2 Rows per year

19.5.3 Notes

Name	Comment	Value
Visibility	Data in this table is:	Public

19.5.4 Primary Key Columns

- Name
- MR_DATE
- REGIONID

VERSION_DATETIME

19.5.5 Index Columns

Name

LASTCHANGED

19.5.6 Content

Name	Data Type	Mandatory	Comment
MR_DATE	DATE	X	Mandatory Restriction imposition date
REGIONID	VARCHAR2(10)	X	Unique RegionID
VERSION_DATETIME	DATE	X	Effective Date/Time of Schedule; Allows many Stack versions
DEMAND_EFFECTIVEDATE	DATE		Foreign key reference to ResDemandTrk.EffectiveDate
DEMAND_OFFERDATE	DATE		Foreign key reference to ResDemandTrk.OfferDate
DEMAND_VERSIONNO	NUMBER(3,0)		Foreign key reference to ResDemandTrk.VersionNo
AUTHORISED_BY	VARCHAR2(20)		Authorised person confirming Offer Stack (AKA Acceptance)
AUTHORISED_DATE	DATE		Date and time the Offer Stack confirmed
LASTCHANGED	DATE		Date and time the record was inserted/modified

19.6 Table: MR_PEROFFER_STACK

19.6.1 MR_PEROFFER_STACK

Name	MR_PEROFFER_STACK
Comment	MR_PEROFFER_STACK defines the accepted capacity on a period basis for the Acceptance Schedule, is a child table to MR_DayOffer_Stack and only includes records or units with accepted_capacity > 0 for the specific period.

19.6.2 Description

Once the offer cut off time has passed and as the schedule changes AEMO is obliged to accept MR capacity to meet the schedule in merit order according to the offers submitted. The relationship to a specific schedule, the merit order of submitted offers and accepted quantities for each trading interval are stored in MR_Event_Schedule, MR_DayOffer_Stack and MR_PerOffer_Stack.

MR_PEROFFER_STACK reports the accepted MR capacity (Accepted_Capacity) required from each unit for each trading interval. MR_PEROFFER_STACK is sparse so lists only units with accepted capacity > 0 for that trading interval. The Deducted_Capacity field allows the tracking and implementation of participant requested reductions to accepted MR capacity to be tracked and applied. MR_PEROFFER_STACK is reported confidentially to each participant to notify acceptance of an MR offer.

Source

MR_PEROFFER_STACK updates are ad hoc.

Volume

4800 rows per year

19.6.3 Notes

Name	Comment	Value
Visibility	Data in this table is:	Private; Public Next-Day

19.6.4 Primary Key Columns

Name	
MR_DATE	

PERIODID

REGIONID

STACK_POSITION

VERSION_DATETIME

19.6.5 Index Columns

Name

LASTCHANGED

19.6.6 Content

Name	Data Type	Mandatory	Comment
MR_DATE	DATE	X	Mandatory Restriction imposition date
REGIONID	VARCHAR2(10)	X	Unique RegionID
VERSION_DATETIME	DATE	X	Allows many Period Stack versions for the one Scaling Factor stack
STACK_POSITION	NUMBER(3,0)	X	LAOF Stack order
PERIODID	NUMBER(3,0)	X	Trade Period for the MR Offer
DUID	VARCHAR2(10)		Dispatchable Unit ID or LinkID. Only required here for CSV reports
ACCEPTED_CAPACITY	NUMBER(6,0)		MR Capacity to be Dispatched
DEDUCTED_CAPACITY	NUMBER(6,0)		Requested capacity reduction amount
LASTCHANGED	DATE		Date and time the record was last

			inserted/modified
--	--	--	-------------------

20 Package: MTPASA

<i>Name</i>	MTPASA
<i>Comment</i>	Results from a published Medium Term PASA Run and region-aggregate offered PASA Availability of scheduled generators

20.1 List of tables

Name	Comment
MTPASA_CASERESULT	MTPASA solution header table
MTPASA_CONSTRAINTRESULT	Constraint results for Binding or Violating Constraints
MTPASA_CONSTRAINTSUMMARY	Constraint Summary results over aggregation periods
MTPASA_INTERCONNECTORRESULT	Interconnector results for interval of max demand per day
MTPASA_LOLRESULT	Results for Loss of Load Probability (LOLP) run per day
MTPASA_REGIONAVAIL_TRK	The tracking table to assist in versioning of the region-aggregate offered PASA Availability data published to the MTPASA_REGIONAVAILABILITY table.
MTPASA_REGIONAVAILABILITY	Stores the Region-aggregate offered PASA Availability of scheduled generators for each day over the Medium Term PASA period. The data in this table is an aggregate of input data to the MT PASA process it is not part of the MTPASA solution. The aggregate availability does not reflect any energy limitations in the MT PASA offers.
MTPASA_REGIONITERATION	Region results for Unserved Energy (USE)
MTPASA_REGIONRESULT	Region results for interval of max demand per day.
MTPASA_REGIONSUMMARY	Region Results summary over aggregation periods.

20.2 Diagram: Entities: MT PASA

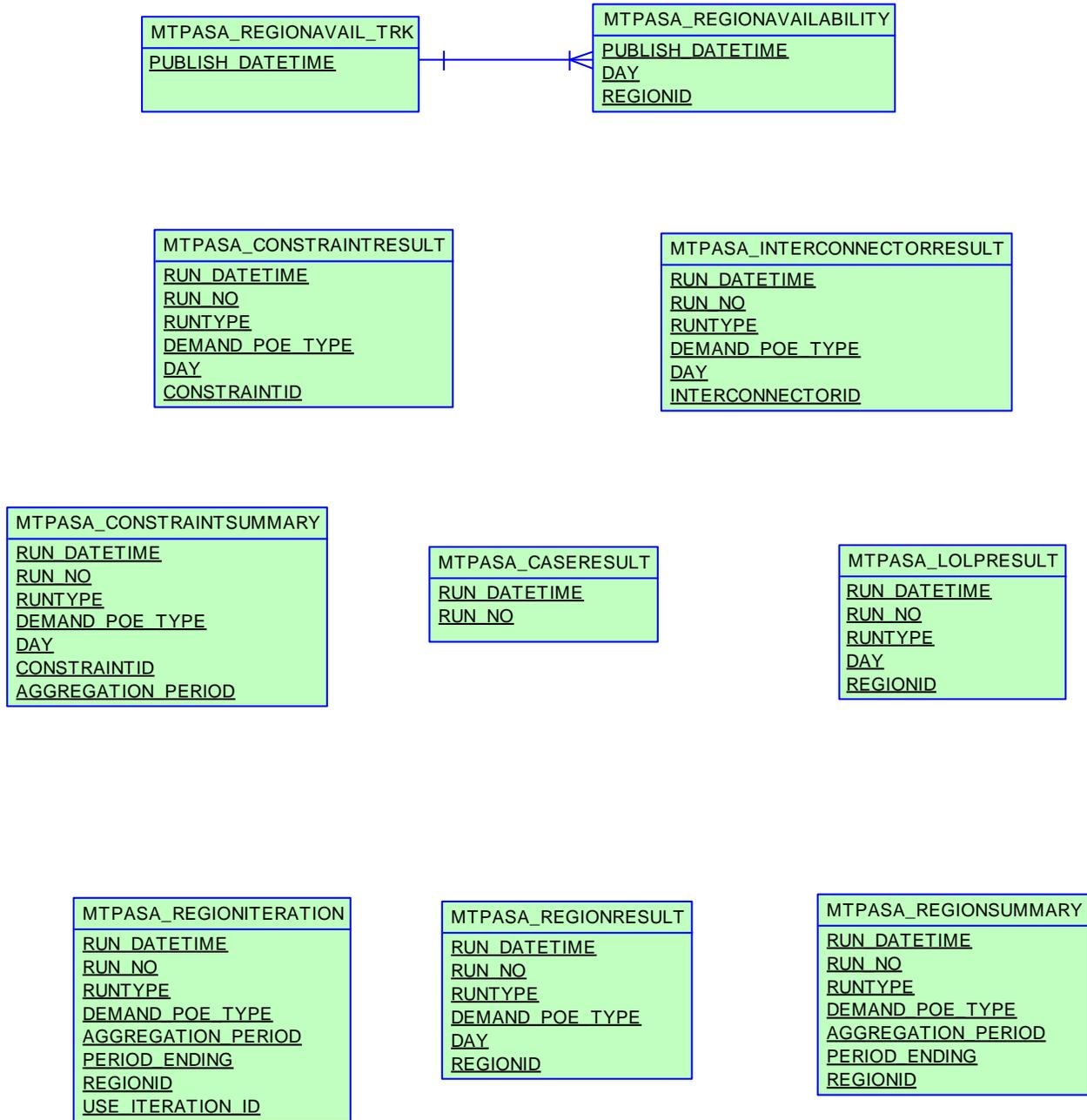

20.3 Table: MTPASA_CASERESULT

20.3.1 MTPASA_CASERESULT

Name	MTPASA_CASERESULT
Comment	MTPASA solution header table

20.3.2 Description

MTPASA_CASERESULT is public data.

Holds one Record for entire solution

20.3.3 Notes

Name	Comment	Value
Visibility	Data in this table is:	Public

20.3.4 Primary Key Columns

Name

RUN_DATETIME

RUN_NO

20.3.5 Content

Name	Data Type	Mandatory	Comment
RUN_DATETIME	DATE	X	Date processing of the run begins.
RUN_NO	NUMBER(4)	X	Unique run id.
PLEXOS_VERSION	VARCHAR2(20)		Version of PLEXOS used

LASTCHANGED	DATE		Last date and time record changed
-------------	------	--	-----------------------------------

20.4 Table: MTPASA_CONSTRAINTRESULT

20.4.1 MTPASA_CONSTRAINTRESULT

Name MTPASA_CONSTRAINTRESULT
Comment Constraint results for Binding or Violating Constraints

20.4.2 Description

MTPASA_CONSTRAINTRESULT is public data.

20.4.3 Notes

Name	Comment	Value
Visibility	Data in this table is:	Public

20.4.4 Primary Key Columns

Name
CONSTRAINTID
DAY
DEMAND_POE_TYPE
RUN_DATETIME
RUN_NO
RUNTYPE

20.4.5 Content

Name	Data Type	Mandatory	Comment
------	-----------	-----------	---------

RUN_DATETIME	DATE	X	Date processing of the run begins.
RUN_NO	NUMBER(4)	X	Unique run id.
RUNTYPE	VARCHAR2(20)	X	Type of run. Always RELIABILITY
DEMAND_POE_TYPE	VARCHAR2(20)	X	Demand POE type used. Value is POE10
DAY	DATE	X	Day this result is for
CONSTRAINTID	VARCHAR2(20)	X	The unique identifier for the constraint. Only binding or violating constraints are reported
EFFECTIVEDATE	DATE		The effective date of the constraint used
VERSIONNO	NUMBER(3,0)		The version of the constraint used
PERIODID	NUMBER(3,0)		Half hourly period reported, selected as period of maximum NEM scheduled demand (calculated as maximum of scheduled demands, averaged across iterations and reference years)
PROBABILITYOFBINDING	NUMBER(8,5)		Proportion of a constraint binding, across iterations and reference years
PROBABILITYOFVIOLATION	NUMBER(8,5)		Proportion of a constraint violating, across iterations and reference years
CONSTRAINTVIOLATION90	NUMBER(12,2)		The 90th percentile violation degree for this constraint, across iterations and reference years (MW)

CONSTRAINTVIOLATION5 0	NUMBER(12,2)		The 50th percentile violation degree for this constraint, across iterations and reference years (MW)
CONSTRAINTVIOLATION1 0	NUMBER(12,2)		The 10th percentile violation degree for this constraint, across iterations and reference years (MW)
LASTCHANGED	DATE		Last date and time record changed

20.5 Table: MTPASA_CONSTRAINTSUMMARY

20.5.1 MTPASA_CONSTRAINTSUMMARY

Name MTPASA_CONSTRAINTSUMMARY
 Comment Constraint Summary results over aggregation periods

20.5.2 Description

MTPASA_CONSTRAINTSUMMARY is public data.

20.5.3 Notes

Name	Comment	Value
Visibility	Data in this table is:	Public

20.5.4 Primary Key Columns

Name
 AGGREGATION_PERIOD
 CONSTRAINTID
 DAY
 DEMAND_POE_TYPE
 RUN_DATETIME
 RUN_NO
 RUNTYPE

20.5.5 Content

Name	Data Type	Manda	Comment
------	-----------	-------	---------

		tory	
RUN_DATETIME	DATE	X	Date processing of the run begins.
RUN_NO	NUMBER(4)	X	Unique run id.
RUNTYPE	VARCHAR2(20)	X	Type of run. Always RELIABILITY
DEMAND_POE_TYPE	VARCHAR2(20)	X	Demand POE type used. Value is POE10
DAY	DATE	X	Day this result is for
CONSTRAINTID	VARCHAR2(20)	X	The unique identifier for the constraint. Only binding or violating constraints are reported
EFFECTIVEDATE	DATE		The effective date of the constraint used
VERSIONNO	NUMBER(3,0)		The version of the constraintID
AGGREGATION_PERIOD	VARCHAR2(20)	X	Period data is aggregated over. Values are PEAK, SHOULDER, OFFPEAK. PEAK = 14:00-19:59, SHOULDER = 07:00-13:59 and 20:00-21:59, OFFPEAK = 22:00-06:59
CONSTRAINTHOURSBINDING	NUMBER(12,2)		Constraint hours binding or violating for period, averaged across iterations and reference years
LASTCHANGED	DATE		Last date and time record changed

20.6 Table: MTPASA_INTERCONNECTORRESULT

20.6.1 MTPASA_INTERCONNECTORRESULT

Name	MTPASA_INTERCONNECTORRESULT
Comment	Interconnector results for interval of max demand per day

20.6.2 Description

MTPASA_INTERCONNECTORRESULT is public data.

20.6.3 Notes

Name	Comment	Value
Visibility	Data in this table is:	Public

20.6.4 Primary Key Columns

Name
 DAY
 DEMAND_POE_TYPE
 INTERCONNECTORID
 RUN_DATETIME
 RUN_NO
 RUNTYPE

20.6.5 Content

Name	Data Type	Mandatory	Comment
------	-----------	-----------	---------

RUN_DATETIME	DATE	X	Date processing of the run begins.
RUN_NO	NUMBER(4)	X	Unique run id.
RUNTYPE	VARCHAR2(20)	X	Type of run. Always RELIABILITY
DEMAND_POE_TYPE	VARCHAR2(20)	X	Demand POE type used. Value is POE10
DAY	DATE	X	Day this result is for
INTERCONNECTORID	VARCHAR2(20)	X	The unique identifier for the interconnector
PERIODID	NUMBER(3,0)		Half hourly period reported, selected as period of maximum NEM scheduled demand (calculated as maximum of scheduled demands, averaged across iterations and reference years)
FLOW90	NUMBER(12,2)		The 90th percentile for flows, across iterations and reference years. Positive values indicate exporting, negative values indicate importing (MW)
FLOW50	NUMBER(12,2)		The 50th percentile for flows, across iterations and reference years. Positive values indicate exporting, negative values indicate importing (MW)
FLOW10	NUMBER(12,2)		The 10th percentile for flows, across iterations and reference years. Positive values indicate exporting, negative values indicate importing (MW)

PROBABILITYOFBINDINGEXPORT	NUMBER(8,5)		Proportion of iterations and reference years with interconnector constrained when exporting
PROBABILITYOFBINDINGIMPORT	NUMBER(8,5)		Proportion of iterations and reference years with interconnector constrained when importing
CALCULATEDEXPORTLIMIT	NUMBER(12,2)		Calculated Interconnector limit of exporting energy on the basis of invoked constraints and static interconnector export limit, averaged across iterations and reference years
CALCULATEDIMPORTLIMIT	NUMBER(12,2)		Calculated Interconnector limit of importing energy on the basis of invoked constraints and static interconnector import limit, averaged across iterations and reference years
LASTCHANGED	DATE		Last date and time record changed

20.7 Table: MTPASA_LOLRESULT

20.7.1 MTPASA_LOLRESULT

Name MTPASA_LOLRESULT
 Comment Results for Loss of Load Probability (LOLP) run per day

20.7.2 Description

MTPASA_LOLRESULT is public data.

20.7.3 Notes

Name	Comment	Value
Visibility	Data in this table is:	Public

20.7.4 Primary Key Columns

Name
 DAY
 REGIONID
 RUN_DATETIME
 RUN_NO
 RUNTYPE

20.7.5 Content

Name	Data Type	Mandatory	Comment
RUN_DATETIME	DATE	X	Date processing of the run begins.

RUN_NO	NUMBER(4)	X	Unique run id.
RUNTYPE	VARCHAR2(20)	X	Type of run. Always LOLP
DAY	DATE	X	Day this result is for
REGIONID	VARCHAR2(20)	X	The unique region identifier
WORST_INTERVAL_PERIOD ID	NUMBER(3,0)		The half hourly interval period with the highest LOLP, or highest region demand if LOLP = 0 for all intervals (1..48)
WORST_INTERVAL_DEMAND	NUMBER(12,2)		The Abstract Operational Demand for the worst interval in this region (MW)
WORST_INTERVAL_INTGEN	NUMBER(12,2)		The half hourly aggregate intermittent generation for the worst interval in this region (MW)
WORST_INTERVAL_DSP	NUMBER(12,2)		The half hourly aggregate demand side participation for the worst interval period in this region (MW)
LOSSOFLOADPROBABILITY	NUMBER(8,5)		Loss of Load Probability for the worst interval in this region
LOSSOFLOADMAGNITUDE	VARCHAR2(20)		Loss of Load Magnitude for the worst interval in this region. Values are LOW, MEDIUM, HIGH
LASTCHANGED	DATE		Last date and time record changed

20.8 Table: MTPASA_REGIONAVAIL_TRK

20.8.1 MTPASA_REGIONAVAIL_TRK

Name MTPASA_REGIONAVAIL_TRK

Comment The tracking table to assist in versioning of the region-aggregate offered PASA Availability data published to the MTPASA_REGIONAVAILABILITY table.

20.8.2 Notes

Name	Comment	Value
Visibility	Data in this table is:	Public

20.8.3 Primary Key Columns

Name

PUBLISH_DATETIME

20.8.4 Content

Name	Data Type	Mandatory	Comment
PUBLISH_DATETIME	DATE	X	Date Time the report was published.
STARTDATE	DATE		First date of the report inclusive.
ENDDATE	DATE		Last date of the report inclusive.
LATEST_OFFER_DATETIME	DATE		Date Time of the latest offer used in the report.

20.9 Table: MTPASA_REGIONAVAILABILITY

20.9.1 MTPASA_REGIONAVAILABILITY

Name MTPASA_REGIONAVAILABILITY

Comment Stores the Region-aggregate offered PASA Availability of scheduled generators for each day over the Medium Term PASA period. The data in this table is an aggregate of input data to the MT PASA process it is not part of the MTPASA solution. The aggregate availability does not reflect any energy limitations in the MT PASA offers.

20.9.2 Description

MTPASA_REGIONAVAILABILITY is public data.

20.9.3 Notes

Name	Comment	Value
Visibility	Data in this table is:	Public

20.9.4 Primary Key Columns

Name

DAY

PUBLISH_DATETIME

REGIONID

20.9.5 Content

Name	Data Type	Mandatory	Comment
PUBLISH_DATETIME	DATE	X	Date Time the report was published.

DAY	DATE	X	Date on which the aggregation applies.
REGIONID	VARCHAR2(20)	X	NEM Region.
PASAAVAILABILITY_SCHEDULED	NUMBER(12,0)		Aggregate of the offered PASA Availability for all Scheduled generators in this region.
LATEST_OFFER_DATETIME	DATE		Date Time of the latest offer used in the aggregation for this region and date.
ENERGYUNCONSTRAINEDCAPACITY	NUMBER(12,0)		Region energy unconstrained MW capacity
ENERGYCONSTRAINEDCAPACITY	NUMBER(12,0)		Region energy constrained MW capacity
NONSCHEДУLEDGENERATION	NUMBER(12,2)		Allowance made for non-scheduled generation in the demand forecast (MW)
DEMAND10	NUMBER(12,2)		10% probability demand (ex non-scheduled demand)
DEMAND50	NUMBER(12,2)		50% probability demand (ex non-scheduled demand)
ENERGYREQDEMAND10	NUMBER(12,2)		Total weekly operational as generated consumption (POE 10)
ENERGYREQDEMAND50	NUMBER(12,2)		Total weekly operational as generated consumption (POE 50)
LASTCHANGED	DATE		Last date and time record changed

20.10 Table: MTPASA_REGIONITERATION

20.10.1 MTPASA_REGIONITERATION

Name	MTPASA_REGIONITERATION
Comment	Region results for Unserved Energy (USE)

20.10.2 Description

MTPASA_REGIONITERATION is public data.

20.10.3 Notes

Name	Comment	Value
Visibility	Data in this table is:	Public

20.10.4 Primary Key Columns

Name

AGGREGATION_PERIOD

DEMAND_POE_TYPE

PERIOD_ENDING

REGIONID

RUN_DATETIME

RUN_NO

RUNTYPE

USE_ITERATION_ID

20.10.5 Content

Name	Data Type	Mandatory	Comment
RUN_DATETIME	DATE	X	Date processing of the run begins.
RUN_NO	NUMBER(4)	X	Unique run id.
RUNTYPE	VARCHAR2(20)	X	Type of run. Always RELIABILITY
DEMAND_POE_TYPE	VARCHAR2(20)	X	Demand POE type used. Value is POE10 or POE50
AGGREGATION_PERIOD	VARCHAR2(20)	X	Period data is aggregated over. Values are YEAR
PERIOD_ENDING	DATE	X	Datetime of day at end of period (i.e. last day of year reported)
REGIONID	VARCHAR2(20)	X	The unique region identifier
USE_ITERATION_ID	NUMBER(5)	X	Iteration ID, only produced for iterations showing unserved energy > 0
USE_ITERATION_EVENT_NUMBER	NUMBER(12,2)		Number of half hours showing unserved energy over year, for iteration
USE_ITERATION_EVENT_AVERAGE	NUMBER(12,2)		Average unserved energy event size for iteration over year (MW)
LASTCHANGED	DATE		Last date and time record changed

20.11 Table: MTPASA_REGIONRESULT

20.11.1 MTPASA_REGIONRESULT

Name MTPASA_REGIONRESULT
Comment Region results for interval of max demand per day.

20.11.2 Description

MTPASA_REGIONRESULT is public data.

20.11.3 Notes

Name	Comment	Value
Visibility	Data in this table is:	Public

20.11.4 Primary Key Columns

Name
DAY
DEMAND_POE_TYPE
REGIONID
RUN_DATETIME
RUN_NO
RUNTYPE

20.11.5 Content

Name	Data Type	Mandatory	Comment
------	-----------	-----------	---------

RUN_DATETIME	DATE	X	Date processing of the run begins.
RUN_NO	NUMBER(4)	X	Unique run id.
RUNTYPE	VARCHAR2(20)	X	Type of run. Always RELIABILITY
DEMAND_POE_TYPE	VARCHAR2(20)	X	Demand POE type used. Value is POE10
DAY	DATE	X	Day this result is for
REGIONID	VARCHAR2(20)	X	The unique region identifier
PERIODID	NUMBER(3,0)		Half hourly period reported, selected as period of maximum NEM scheduled demand (calculated as maximum of scheduled demands, averaged across iterations and reference years)
DEMAND	NUMBER(12,2)		Demand value from selected half hourly interval (MW)
AGGREGATEINSTALLEDCAPACITY	NUMBER(12,2)		The total installed capacity of all generation (MW)
NUMBEROFITERATIONS	NUMBER(12,2)		Total number of iterations and reference years performed
USE_NUMBEROFITERATIONS	NUMBER(12,2)		Number of iterations and reference years with unserved energy > 0
USE_MAX	NUMBER(12,2)		Maximum unserved energy, across iterations and reference years (MW)
USE_UPPERQUARTILE	NUMBER(12,2)		Upper quartile unserved energy, across iterations and reference years (MW)

USE_MEDIAN	NUMBER(12,2)		Median unserved energy, across iterations and reference years (MW)
USE_LOWERQUARTILE	NUMBER(12,2)		Lower quartile unserved energy, across iterations and reference years (MW)
USE_MIN	NUMBER(12,2)		Minimum unserved energy, across iterations and reference years (MW)
USE_AVERAGE	NUMBER(12,2)		Average unserved energy, across iterations and reference years (MW)
USE_EVENT_AVERAGE	NUMBER(12,2)		Average unserved energy event size, across iterations and reference years (MW)
TOTALSCHEDULEDGEN90	NUMBER(12,2)		The 90th percentile for scheduled generation across iterations and reference years (MW)
TOTALSCHEDULEDGEN50	NUMBER(12,2)		The 50th percentile for scheduled generation across iterations and reference years (MW)
TOTALSCHEDULEDGEN10	NUMBER(12,2)		The 10th percentile for scheduled generation across iterations and reference years (MW)
TOTALINTERMITTENTGEN90	NUMBER(12,2)		The 90th percentile for intermittent generation, across iterations and reference years (MW)
TOTALINTERMITTENTGEN50	NUMBER(12,2)		The 50th percentile for intermittent generation, across iterations and reference years (MW)
TOTALINTERMITTENTGEN10	NUMBER(12,2)		The 10th percentile for intermittent generation, across iterations and

0			reference years (MW)
DEMANDSIDEPARTICIPATION90	NUMBER(12,2)		The 90th percentile for demand side participation, across iterations and reference years (MW)
DEMANDSIDEPARTICIPATION50	NUMBER(12,2)		The 50th percentile for demand side participation, across iterations and reference years (MW)
DEMANDSIDEPARTICIPATION10	NUMBER(12,2)		The 10th percentile for demand side participation, across iterations and reference years (MW)
LASTCHANGED	DATE		Last date and time record changed
TOTALSEMISCHEDULEGEN90	NUMBER(12,2)		The 90% percentile for semi-scheduled generation across iterations and reference years (MW)
TOTALSEMISCHEDULEGEN50	NUMBER(12,2)		The 50% percentile for semi-scheduled generation across iterations and reference years (MW)
TOTALSEMISCHEDULEGEN10	NUMBER(12,2)		The 10% percentile for semi-scheduled generation across iterations and reference years (MW)

20.12 Table: MTPASA_REGIONSUMMARY

20.12.1 MTPASA_REGIONSUMMARY

Name MTPASA_REGIONSUMMARY
 Comment Region Results summary over aggregation periods.

20.12.2 Description

MTPASA_REGIONSUMMARY is public data.

20.12.3 Notes

Name	Comment	Value
Visibility	Data in this table is:	Public

20.12.4 Primary Key Columns

Name
 AGGREGATION_PERIOD
 DEMAND_POE_TYPE
 PERIOD_ENDING
 REGIONID
 RUN_DATETIME
 RUN_NO
 RUNTYPE

20.12.5 Content

Name	Data Type	Manda	Comment
------	-----------	-------	---------

		tory	
RUN_DATETIME	DATE	X	Date processing of the run begins.
RUN_NO	NUMBER(4)	X	Unique run id.
RUNTYPE	VARCHAR2(20)	X	Type of run. Always RELIABILITY
DEMAND_POE_TYPE	VARCHAR2(20)	X	Demand POE type used. Value are POE10, POE50
AGGREGATION_PERIOD	VARCHAR2(20)	X	Period data is aggregated over. Values are YEAR, MONTH
PERIOD_ENDING	DATE	X	Datetime of day at end of period (i.e. last day of month or year reported)
REGIONID	VARCHAR2(20)	X	The unique region identifier
NATIVEDEMAND	NUMBER(12,2)		Native demand calculated from Operational As Generated trace supplied by Energy Forecasting
USE_PERCENTILE10	NUMBER(12,2)		Unreserved energy period amount at the 10th percentile of iterations and reference years (MWh)
USE_PERCENTILE20	NUMBER(12,2)		Unreserved energy period amount at the 20th percentile of iterations and reference years (MWh)
USE_PERCENTILE30	NUMBER(12,2)		Unreserved energy period amount at the 30th percentile of iterations and reference years (MWh)
USE_PERCENTILE40	NUMBER(12,2)		Unreserved energy period amount at the 40th percentile of iterations and reference years (MWh)

USE_PERCENTILE50	NUMBER(12,2)		Unserviced energy period amount at the 50th percentile of iterations and reference years (MWh)
USE_PERCENTILE60	NUMBER(12,2)		Unserviced energy period amount at the 60th percentile of iterations and reference years (MWh)
USE_PERCENTILE70	NUMBER(12,2)		Unserviced energy period amount at the 70th percentile of iterations and reference years (MWh)
USE_PERCENTILE80	NUMBER(12,2)		Unserviced energy period amount at the 80th percentile of iterations and reference years (MWh)
USE_PERCENTILE90	NUMBER(12,2)		Unserviced energy period amount at the 90th percentile of iterations and reference years (MWh)
USE_PERCENTILE100	NUMBER(12,2)		Unserviced energy period amount at the 100th percentile of iterations and reference years (MWh)
USE_AVERAGE	NUMBER(12,2)		Average period unserved energy across iterations and reference years (MWh)
NUMBEROFITERATIONS	NUMBER(12,2)		Total number of iterations and reference years performed
USE_NUMBEROFITERATIONS	NUMBER(12,2)		Number of iterations and reference years showing unserved energy
USE_EVENT_MAX	NUMBER(12,2)		Maximum unserved energy event size across all half hourly intervals and iterations and reference years that have unserved energy > 0 (MW)
USE_EVENT_UPPERQUARTILE	NUMBER(12,2)		Upper quartile unserved energy event size across all half hourly

LE			intervals and iterations and reference years that have unserved energy>0 (MW)
USE_EVENT_MEDIAN	NUMBER(12,2)		Median unserved energy event size across all half hourly intervals and iterations and reference years that have unserved energy>0 (MW)
USE_EVENT_LOWERQUARTILE	NUMBER(12,2)		Lower quartile unserved energy event size across all half hourly intervals and iterations and reference years that have unserved energy>0 (MW)
USE_EVENT_MIN	NUMBER(12,2)		Minimum unserved energy event size across all half hourly intervals and iterations and reference years that have unserved energy>0 (MW)
WEIGHT	NUMBER(16,6)		Fixed Values of 0.696 for 50 POE and 0.304 for 10 POE.
USE_WEIGHTED_AVG	NUMBER(16,6)		Weighted average USE per region = (USE_AVERAGE_POE10/NATIVE_DEMAND_POE_10*WEIGHT_POE_10 + USE_AVERAGE_POE50/NATIVE_DEMAND_POE_50*WEIGHT_POE_50)* 100
LRC	NUMBER(12,2)		LRC Condition reported (Value=1) if USE_WEIGHTED_AVG >= 0.002% otherwise (Value=0)
LASTCHANGED	DATE		Last date and time record changed

21 Package: P5MIN

<i>Name</i>	P5MIN
<i>Comment</i>	Results from a published Five-Minute Predispatch Run

21.1 List of tables

Name	Comment
P5MIN_BLOCKEDCONSTRAINT	P5MIN Blocked Constraints lists any constraints that were blocked in a P5MIN run. If no constraints are blocked, there will be no rows for that 5 minute predispatch run.
P5MIN_CASESOLUTION	<p>The five-minute predispatch (P5Min) is a MMS system providing projected dispatch for 12 Dispatch cycles (one hour). The 5-minute Predispatch cycle runs every 5-minutes to produce a dispatch and pricing schedule to a 5-minute resolution covering the next hour, a total of twelve periods.</p> <p>P5MIN_CASESOLUTION shows one record containing results pertaining to the entire solution.</p>
P5MIN_CONSTRAINTSOLUTION	<p>The Five-Minute Pre-Dispatch (P5Min) is a MMS system providing projected dispatch for 12 Dispatch cycles (one hour). The Five-Minute Pre-dispatch cycle runs every 5-minutes to produce a dispatch and pricing schedule to a 5-minute resolution covering the next hour, a total of twelve periods.</p> <p>P5MIN_CONSTRAINTSOLUTION shows binding and violated constraint results from the capacity evaluation, including the RHS value.</p>
P5MIN_INTERCONNECTORSOL	The five-minute predispatch (P5Min) is a MMS system

N	<p>providing projected dispatch for 12 Dispatch cycles (one hour). The 5-minute Predispatch cycle runs every 5-minutes to produce a dispatch and pricing schedule to a 5-minute resolution covering the next hour, a total of twelve periods.</p> <p>P5MIN_INTERCONNECTORSOLN sets out the results of the capacity evaluation for Interconnectors, including the calculated limits for the interval.</p>
P5MIN_LOCAL_PRICE	Sets out local pricing offsets associated with each DUID connection point for each dispatch period
P5MIN_REGIONSOLUTION	<p>The five-minute predispatch (P5Min) is a MMS system providing projected dispatch for 12 Dispatch cycles (one hour). The 5-minute Predispatch cycle runs every 5-minutes to produce a dispatch and pricing schedule to a 5-minute resolution covering the next hour, a total of twelve periods.</p> <p>P5MIN_REGIONSOLUTION shows the results of the regional capacity, maximum surplus reserve and maximum spare capacity evaluations for each period of the study.</p>
P5MIN_UNITSOLUTION	<p>The five-minute predispatch (P5Min) is a MMS system providing projected dispatch for 12 Dispatch cycles (one hour). The 5-minute Predispatch cycle runs every 5-minutes to produce a dispatch and pricing schedule to a 5-minute resolution covering the next hour, a total of twelve periods.</p> <p>P5MIN_UNITSOLUTION shows the Unit results from the capacity evaluations for each period of the study.</p>

21.2 Diagram: Entities: P5MIN

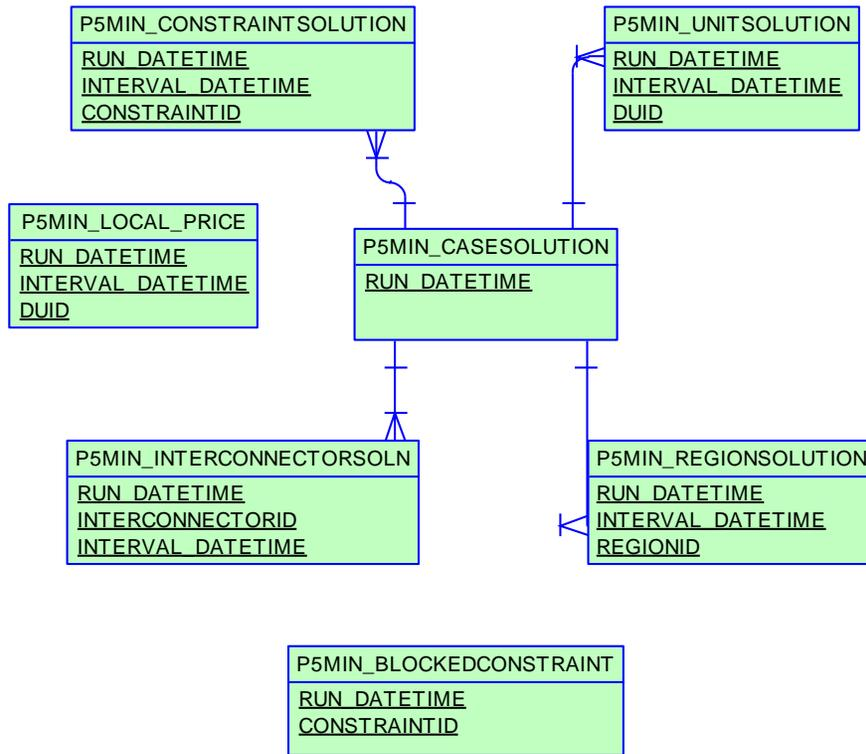

21.3 Table: P5MIN_BLOCKEDCONSTRAINT

21.3.1 P5MIN_BLOCKEDCONSTRAINT

Name	P5MIN_BLOCKEDCONSTRAINT
Comment	P5MIN Blocked Constraints lists any constraints that were blocked in a P5MIN run. If no constraints are blocked, there will be no rows for that 5 minute predispatch run.

21.3.2 Notes

Name	Comment	Value
Visibility	Data in this table is:	Public

21.3.3 Primary Key Columns

Name
CONSTRAINTID
RUN_DATETIME

21.3.4 Content

Name	Data Type	Mandatory	Comment
RUN_DATETIME	DATE	X	5-minute Predispatch Run
CONSTRAINTID	VARCHAR2(20)	X	Generic Constraint identifier (synonymous with GenConID)

21.4 Table: P5MIN_CASESOLUTION

21.4.1 P5MIN_CASESOLUTION

Name	P5MIN_CASESOLUTION
Comment	<p>The five-minute predispach (P5Min) is a MMS system providing projected dispatch for 12 Dispatch cycles (one hour). The 5-minute Predispach cycle runs every 5-minutes to produce a dispatch and pricing schedule to a 5-minute resolution covering the next hour, a total of twelve periods.</p> <p>P5MIN_CASESOLUTION shows one record containing results pertaining to the entire solution.</p>

21.4.2 Description

P5MIN_CASESOLUTION data is public, so is available to all participants.

Source

P5MIN_CASESOLUTION updates every 5 minutes.

Volume

Rows per day: 288

21.4.3 Notes

Name	Comment	Value
Visibility	Data in this table is:	Public

21.4.4 Primary Key Columns

Name	
	RUN_DATETIME

21.4.5 Index Columns

Name

LASTCHANGED

21.4.6 Content

Name	Data Type	Mandatory	Comment
RUN_DATETIME	DATE	X	Unique Timestamp Identifier for this study
STARTINTERVAL_DATETIME	VARCHAR2(20)		Date and Time of first interval in study
TOTALOBJECTIVE	NUMBER(27,10)		The Objective function from the LP
NONPHYSICALLOSSES	NUMBER(1,0)		Flag to indicate non-physical losses occurred in this study
TOTALAREAGENVIOVIOLATION	NUMBER(15,5)		Sum of Regional Energy balance violations
TOTALINTERCONNECTORVIOLATION	NUMBER(15,5)		Sum of Interconnector violations of standing data limits
TOTALGENERICVIOLATION	NUMBER(15,5)		Sum of Generic Constraint violations
TOTALRAMPRATEVIOLATION	NUMBER(15,5)		Sum of Unit Ramp Rate violations
TOTALUNITMWCAPACITYVIOLATION	NUMBER(15,5)		Sum of unit capacity violations
TOTAL5MINVIOLATION	NUMBER(15,5)		Sum of regional 5 min FCAS violations
TOTALREGVIOLATION	NUMBER(15,5)		Sum of regional regulation FCAS

			violations
TOTAL6SECVIOLATION	NUMBER(15,5)		Sum of regional 6 sec FCAS violations
TOTAL60SECVIOLATION	NUMBER(15,5)		Sum of regional 60 sec FCAS violations
TOTALENERGYCONSTRVIOLATION	NUMBER(15,5)		Sum of unit energy constrained violations
TOTALENERGYOFFERVIOLATION	NUMBER(15,5)		Sum of unit offer violations
TOTALASPROFILEVIOLATION	NUMBER(15,5)		Sum of unit FCAS profile offer violations
TOTALFASTSTARTVIOLATION	NUMBER(15,5)		Sum of unit Fast start profile violations
LASTCHANGED	DATE		Last changed date and time of this record
INTERVENTION	Number(2,0)		Flag to indicate if this Predispatch case includes an intervention pricing run: 0 = case does not include an intervention pricing run, 1 = case does include an intervention pricing run. This field has a default value of 0 and is not nullable

21.5 Table: P5MIN_CONSTRAINTSOLUTION

21.5.1 P5MIN_CONSTRAINTSOLUTION

Name	P5MIN_CONSTRAINTSOLUTION
Comment	<p>The Five-Minute Pre-Dispatch (P5Min) is a MMS system providing projected dispatch for 12 Dispatch cycles (one hour). The Five-Minute Pre-dispatch cycle runs every 5-minutes to produce a dispatch and pricing schedule to a 5-minute resolution covering the next hour, a total of twelve periods.</p> <p>P5MIN_CONSTRAINTSOLUTION shows binding and violated constraint results from the capacity evaluation, including the RHS value.</p>

21.5.2 Description

P5MIN_CONSTRAINTSOLUTION is public data, so is available to all participants.

Source

P5MIN_CONSTRAINTSOLUTION updates every five minutes.

Volume

Rows per day: 57600

21.5.3 Notes

Name	Comment	Value
Visibility	Data in this table is:	Private & Public

21.5.4 Primary Key Columns

- Name
- CONSTRAINTID
- INTERVAL_DATETIME
- RUN_DATETIME

21.5.5 Index Columns

Name

LASTCHANGED

21.5.6 Content

Name	Data Type	Mandatory	Comment
RUN_DATETIME	DATE	X	Unique Timestamp Identifier for this study
INTERVAL_DATETIME	DATE	X	The unique identifier for the interval within this study
CONSTRAINTID	VARCHAR2(20)	X	Constraint identifier (synonymous with GenConID)
RHS	NUMBER(15,5)		Right Hand Side value in the capacity evaluation
MARGINALVALUE	NUMBER(15,5)		Marginal cost of constraint (>0 if binding)
VIOLATIONDEGREE	NUMBER(15,5)		Amount of Violation (>0 if violating)
LASTCHANGED	DATE		Last date and time record changed
DUID	VARCHAR2(20)		DUID to which the Constraint is confidential. Null denotes non-confidential
GENCONID_EFFECTIVEDATE	DATE		Effective date of the Generic Constraint (ConstraintID). This field is used to track the version of this generic constraint applied in this dispatch interval

GENCONID_VERSIONNO	NUMBER(22,0)		Version number of the Generic Constraint (ConstraintID). This field is used to track the version of this generic constraint applied in this dispatch interval
LHS	number(15,5)		Aggregation of the constraints LHS term solution values
INTERVENTION	Number(2,0)		Flag to indicate if this result set was sourced from the pricing run (INTERVENTION=0) or the physical run(INTERVENTION=1). In the event there is not intervention in the market, both pricing and physical runs correspond to INTERVENTION=0)

21.6 Table: P5MIN_INTERCONNECTORSOLN

21.6.1 P5MIN_INTERCONNECTORSOLN

Name	P5MIN_INTERCONNECTORSOLN
Comment	<p>The five-minute predispatch (P5Min) is a MMS system providing projected dispatch for 12 Dispatch cycles (one hour). The 5-minute Predispatch cycle runs every 5-minutes to produce a dispatch and pricing schedule to a 5-minute resolution covering the next hour, a total of twelve periods.</p> <p>P5MIN_INTERCONNECTORSOLN sets out the results of the capacity evaluation for Interconnectors, including the calculated limits for the interval.</p>

21.6.2 Description

P5MIN_INTERCONNECTORSOLN is public data, so is available to all participants.

Source

P5MIN_INTERCONNECTORSOLN updates every 5 minutes.

Volume

Rows per day: 1440

Based on 200 interconnector/binding constraints per interval

21.6.3 Notes

Name	Comment	Value
Visibility	Data in this table is:	Public

21.6.4 Primary Key Columns

- Name
- INTERCONNECTORID
- INTERVAL_DATETIME

RUN_DATETIME

21.6.5 Index Columns

Name

LASTCHANGED

21.6.6 Content

Name	Data Type	Mandatory	Comment
RUN_DATETIME	DATE	X	Unique Timestamp Identifier for this study
INTERCONNECTORID	VARCHAR2(10)	X	Interconnector identifier
INTERVAL_DATETIME	DATE	X	The unique identifier for the interval within this study
METEREDMWFLOW	NUMBER(15,5)		SCADA MW Flow measured at Run start. For periods subsequent to the first period of a P5MIN run, this value represents the cleared target for the previous period of that P5MIN run.
MWFLOW	NUMBER(15,5)		Cleared Interconnector loading level (MW)
MWLOSSES	NUMBER(15,5)		Interconnector Losses at cleared flow
MARGINALVALUE	NUMBER(15,5)		Marginal cost of Interconnector standing data limits (if binding)
VIOLATIONDEGREE	NUMBER(15,5)		Violation of Interconnector standing data limits

MNSP	NUMBER(1,0)		Flag indicating MNSP registration
EXPORTLIMIT	NUMBER(15,5)		Calculated Interconnector limit of exporting energy on the basis of invoked constraints and static interconnector export limit
IMPORTLIMIT	NUMBER(15,5)		Calculated Interconnector limit of importing energy on the basis of invoked constraints and static interconnector import limit. Note unlike the input interconnector import limit this is a directional quantity and should be defined with respect to the interconnector flow.
MARGINALLOSS	NUMBER(15,5)		Marginal loss factor at the cleared flow
EXPORTGENCONID	VARCHAR2(20)		Generic Constraint setting the export limit
IMPORTGENCONID	VARCHAR2(20)		Generic Constraint setting the import limit
FCASEXPORTLIMIT	NUMBER(15,5)		Calculated export limit applying to energy + Frequency Controlled Ancillary Services.
FCASIMPORTLIMIT	NUMBER(15,5)		Calculated import limit applying to energy + Frequency Controlled Ancillary Services.
LASTCHANGED	DATE		Last changed date of this record
LOCAL_PRICE_ADJUSTMENT_EXPORT	NUMBER(10,2)		Aggregate Constraint contribution cost of this Interconnector: Sum(MarginalValue x Factor) for all relevant Constraints, for Export (Factor >= 0)

LOCALLY_CONSTRAINED_EXPORT	NUMBER(1,0)		Key for Local_Price_Adjustment_Export: 2 = at least one Outage Constraint; 1 = at least 1 System Normal Constraint (and no Outage Constraint); 0 = No System Normal or Outage Constraints
LOCAL_PRICE_ADJUSTMENT_IMPORT	NUMBER(10,2)		Aggregate Constraint contribution cost of this Interconnector: Sum(MarginalValue x Factor) for all relevant Constraints, for Import (Factor >= 0)
LOCALLY_CONSTRAINED_IMPORT	NUMBER(1,0)		Key for Local_Price_Adjustment_Import: 2 = at least one Outage Constraint; 1 = at least 1 System Normal Constraint (and no Outage Constraint); 0 = No System Normal or Outage Constraints
INTERVENTION	Number(2,0)		Flag to indicate if this result set was sourced from the pricing run (INTERVENTION=0) or the physical run (INTERVENTION=1). In the event there is not intervention in the market, both pricing and physical runs correspond to INTERVENTION=0)

21.7 Table: P5MIN_LOCAL_PRICE

21.7.1 P5MIN_LOCAL_PRICE

Name	P5MIN_LOCAL_PRICE
Comment	Sets out local pricing offsets associated with each DUID connection point for each dispatch period

21.7.2 Notes

Name	Comment	Value
Visibility	Data in this table is:	Public

21.7.3 Primary Key Columns

Name
 DUID
 INTERVAL_DATETIME
 RUN_DATETIME

21.7.4 Index Columns

Name
 RUN_DATETIME
 INTERVAL_DATETIME
 DUID

21.7.5 Content

Name	Data Type	Manda	Comment
------	-----------	-------	---------

		tory	
RUN_DATETIME	DATE	X	Unique Timestamp Identifier for this study
INTERVAL_DATETIME	DATE	X	The unique identifier for the interval within this study
DUID	VARCHAR2(20)	X	Dispatchable unit identifier
LOCAL_PRICE_ADJUSTMENT	NUMBER(10, 2)		Aggregate Constraint contribution cost of this unit: Sum(MarginalValue x Factor) for all relevant Constraints
LOCALLY_CONSTRAINED	NUMBER(1,0)		Key for Local_Price_Adjustment: 2 = at least one Outage Constraint; 1 = at least 1 System Normal Constraint (and no Outage Constraint); 0 = No System Normal or Outage Constraints

21.8 Table: P5MIN_REGIONSOLUTION

21.8.1 P5MIN_REGIONSOLUTION

Name	P5MIN_REGIONSOLUTION
Comment	<p>The five-minute predispach (P5Min) is a MMS system providing projected dispatch for 12 Dispatch cycles (one hour). The 5-minute Predispach cycle runs every 5-minutes to produce a dispatch and pricing schedule to a 5-minute resolution covering the next hour, a total of twelve periods.</p> <p>P5MIN_REGIONSOLUTION shows the results of the regional capacity, maximum surplus reserve and maximum spare capacity evaluations for each period of the study.</p>

21.8.2 Description

P5MIN_REGIONSOLUTION is public data, so is available to all participants.

Source

P5MIN_REGIONSOLUTION updates every 5 minutes.

Volume

Rows per day: 1440

21.8.3 Notes

Name	Comment	Value
Visibility	Data in this table is:	Public

21.8.4 Primary Key Columns

Name	INTERVAL_DATETIME
------	-------------------

REGIONID

RUN_DATETIME

21.8.5 Index Columns

Name

LASTCHANGED

21.8.6 Content

Name	Data Type	Mandatory	Comment
RUN_DATETIME	DATE	X	Unique Timestamp Identifier for this study
INTERVAL_DATETIME	DATE	X	The unique identifier for the interval within this study
REGIONID	VARCHAR2(10)	X	Region Identifier
RRP	NUMBER(15,5)		Region Reference Price (Energy)
ROP	NUMBER(15,5)		Region Override Price (Energy)
EXCESSGENERATION	NUMBER(15,5)		Total Energy Imbalance (MW)
RAISE6SECRRP	NUMBER(15,5)		Region Reference Price (Raise6Sec)
RAISE6SECROP	NUMBER(15,5)		Original regional price (Raise6Sec)
RAISE60SECRRP	NUMBER(15,5)		Region Reference Price (Raise60Sec)
RAISE60SECROP	NUMBER(15,5)		Original regional price (Raise60Sec)
RAISE5MINRRP	NUMBER(15,5)		Region Reference Price (Raise5Min)

RAISE5MINROP	NUMBER(15,5)		Original regional price (Raise5Min)
RAISEREGRRP	NUMBER(15,5)		Region Reference Price (RaiseReg)
RAISEREGROP	NUMBER(15,5)		Original regional price (RaiseReg)
LOWER6SECRRP	NUMBER(15,5)		Region Reference Price (Lower6Sec)
LOWER6SECROP	NUMBER(15,5)		Original regional price (Lower6Sec)
LOWER60SECRRP	NUMBER(15,5)		Region Reference Price (Lower60Sec)
LOWER60SECROP	NUMBER(15,5)		Original regional price (Lower60Sec)
LOWER5MINRRP	NUMBER(15,5)		Region Reference Price (Lower5Min)
LOWER5MINROP	NUMBER(15,5)		Original regional price (Lower5Min)
LOWERREGRRP	NUMBER(15,5)		Region Reference Price (LowerReg)
LOWERREGROP	NUMBER(15,5)		Original regional price (LowerReg)
TOTALDEMAND	NUMBER(15,5)		Regional Demand - NB NOT net of Interconnector flows or Loads
AVAILABLEGENERATION	NUMBER(15,5)		Regional Available generation
AVAILABLELOAD	NUMBER(15,5)		Regional Available Load
DEMANDFORECAST	NUMBER(15,5)		Predicted change in regional demand for this interval
DISPATCHABLEGENERATION	NUMBER(15,5)		Regional Generation Dispatched
DISPATCHABLELOAD	NUMBER(15,5)		Regional Load Dispatched
NETINTERCHANGE	NUMBER(15,5)		Net interconnector Flows

LOWER5MINDISPATCH	NUMBER(15,5)		Not used since Dec 2003. Lower 5 min MW dispatch
LOWER5MINIMPORT	NUMBER(15,5)		Not used since Dec 2003. Lower 5 min MW imported
LOWER5MINLOCALDISPATCH	NUMBER(15,5)		Lower 5 min local dispatch
LOWER5MINLOCALREQ	NUMBER(15,5)		Not used since Dec 2003. Lower 5 min local requirement
LOWER5MINREQ	NUMBER(15,5)		Not used since Dec 2003. Lower 5 min total requirement
LOWER60SECDISPATCH	NUMBER(15,5)		Not used since Dec 2003. Lower 60 sec MW dispatch
LOWER60SECIMPORT	NUMBER(15,5)		Not used since Dec 2003. Lower 60 sec MW imported
LOWER60SECLOCALDISPATCH	NUMBER(15,5)		Lower 60 sec local dispatch
LOWER60SECLOCALREQ	NUMBER(15,5)		Not used since Dec 2003. Lower 60 sec local requirement
LOWER60SECREQ	NUMBER(15,5)		Not used since Dec 2003. Lower 60 sec total requirement
LOWER6SECDISPATCH	NUMBER(15,5)		Not used since Dec 2003. Lower 6 sec MW dispatch
LOWER6SECIMPORT	NUMBER(15,5)		Not used since Dec 2003. Lower 6 sec MW imported
LOWER6SECLOCALDISPATCH	NUMBER(15,5)		Lower 6 sec local dispatch
LOWER6SECLOCALREQ	NUMBER(15,5)		Not used since Dec 2003. Lower 6 sec local requirement

LOWER6SECREQ	NUMBER(15,5)		Not used since Dec 2003. Lower 6 sec total requirement
RAISE5MINDISPATCH	NUMBER(15,5)		Not used since Dec 2003. Total Raise 5 min MW dispatch
RAISE5MINIMPORT	NUMBER(15,5)		Not used since Dec 2003. Raise 5 min MW imported
RAISE5MINLOCALDISPATCH	NUMBER(15,5)		Raise 5 min local dispatch
RAISE5MINLOCALREQ	NUMBER(15,5)		Not used since Dec 2003. Raise 5 min local requirement
RAISE5MINREQ	NUMBER(15,5)		Not used since Dec 2003. Raise 5 min total requirement
RAISE60SECDISPATCH	NUMBER(15,5)		Not used since Dec 2003. Raise 60 sec MW dispatch
RAISE60SECIMPORT	NUMBER(15,5)		Not used since Dec 2003. Raise 60 sec MW imported
RAISE60SECLOCALDISPATCH	NUMBER(15,5)		Raise 50 sec local dispatch
RAISE60SECLOCALREQ	NUMBER(15,5)		Not used since Dec 2003. Raise 60 sec local requirement
RAISE60SECREQ	NUMBER(15,5)		Not used since Dec 2003. Raise 60 sec total requirement
RAISE6SECDISPATCH	NUMBER(15,5)		Not used since Dec 2003. Raise 6 sec MW dispatch
RAISE6SECIMPORT	NUMBER(15,5)		Not used since Dec 2003. Raise 6 sec MW imported
RAISE6SECLOCALDISPATCH	NUMBER(15,5)		Raise 6 sec local dispatch

RAISE6SECLOCALREQ	NUMBER(15,5)		Not used since Dec 2003. Raise 6 sec local requirement
RAISE6SECREQ	NUMBER(15,5)		Not used since Dec 2003. Raise 6 sec total requirement
AGGREGATEDISPATCHERROR	NUMBER(15,5)		Aggregate dispatch error applied
INITIALSUPPLY	NUMBER(15,5)		Sum of initial generation and import for region
CLEAREDSUPPLY	NUMBER(15,5)		Sum of cleared generation and import for region
LOWERREGIMPORT	NUMBER(15,5)		Not used since Dec 2003. Lower Regulation MW imported
LOWERREGDISPATCH	NUMBER(15,5)		Not used since Dec 2003. Total Lower Regulation dispatch
LOWERREGLOCALDISPATCH	NUMBER(15,5)		Lower Regulation local dispatch
LOWERREGLOCALREQ	NUMBER(15,5)		Not used since Dec 2003. Lower Regulation local requirement
LOWERREGREQ	NUMBER(15,5)		Not used since Dec 2003. Lower Regulation total requirement
RAISEREGIMPORT	NUMBER(15,5)		Not used since Dec 2003. Raise Regulation MW imported
RAISEREGDISPATCH	NUMBER(15,5)		Not used since Dec 2003. Total Raise Regulation dispatch
RAISEREGLOCALDISPATCH	NUMBER(15,5)		Raise Regulation local dispatch
RAISEREGLOCALREQ	NUMBER(15,5)		Not used since Dec 2003. Raise Regulation local requirement
RAISEREGREQ	NUMBER(15,5)		Not used since Dec 2003. Raise

			Regulation total requirement
RAISE5MINLOCALVIOLATION	NUMBER(15,5)		Not used since Dec 2003. Violation (MW) of Raise 5 min local requirement
RAISEREGLOCALVIOLATION	NUMBER(15,5)		Not used since Dec 2003. Violation (MW) of Raise Reg local requirement
RAISE60SECLOCALVIOLATION	NUMBER(15,5)		Not used since Dec 2003. Violation (MW) of Raise 60 sec local requirement
RAISE6SECLOCALVIOLATION	NUMBER(15,5)		Not used since Dec 2003. Violation (MW) of Raise 6 sec local requirement
LOWER5MINLOCALVIOLATION	NUMBER(15,5)		Not used since Dec 2003. Violation (MW) of Lower 5 min local requirement
LOWERREGLOCALVIOLATION	NUMBER(15,5)		Not used since Dec 2003. Violation (MW) of Lower Reg local requirement
LOWER60SECLOCALVIOLATION	NUMBER(15,5)		Not used since Dec 2003. Violation (MW) of Lower 60 sec local requirement
LOWER6SECLOCALVIOLATION	NUMBER(15,5)		Not used since Dec 2003. Violation (MW) of Lower 6 sec local requirement
RAISE5MINVIOLATION	NUMBER(15,5)		Not used since Dec 2003. Violation (MW) of Raise 5 min requirement
RAISEREGVIOLATION	NUMBER(15,5)		Not used since Dec 2003. Violation (MW) of Raise Reg requirement
RAISE60SECVIOLATION	NUMBER(15,5)		Not used since Dec 2003. Violation (MW) of Raise 60 seconds

			requirement
RAISE6SECVIOLATION	NUMBER(15,5)		Not used since Dec 2003. Violation (MW) of Raise 6 seconds requirement
LOWER5MINVIOLATION	NUMBER(15,5)		Not used since Dec 2003. Violation (MW) of Lower 5 min requirement
LOWERREGVIOLATION	NUMBER(15,5)		Not used since Dec 2003. Violation (MW) of Lower Reg requirement
LOWER60SECVIOLATION	NUMBER(15,5)		Not used since Dec 2003. Violation (MW) of Lower 60 seconds requirement
LOWER6SECVIOLATION	NUMBER(15,5)		Not used since Dec 2003. Violation (MW) of Lower 6 seconds requirement
LASTCHANGED	DATE		Last date and time record changed
TOTALINTERMITTENTGENERATION	NUMBER(15,5)		Allowance made for non-scheduled generation in the demand forecast (MW).
DEMAND_AND_NONSCHE DGEN	NUMBER(15,5)		Sum of Cleared Scheduled generation, imported generation (at the region boundary) and allowances made for non-scheduled generation (MW).
UIGF	NUMBER(15,5)		Regional aggregated Unconstrained Intermittent Generation Forecast of Semi-scheduled generation (MW).
SEMISCHEDULE_CLEARED MW	NUMBER(15,5)		Regional aggregated Semi-Schedule generator Cleared MW
SEMISCHEDULE_COMPLIANCE MW	NUMBER(15,5)		Regional aggregated Semi-Schedule generator Cleared MW

			where Semi-Dispatch cap is enforced
INTERVENTION	Number(2,0)		Flag to indicate if this result set was sourced from the pricing run (INTERVENTION=0) or the physical run (INTERVENTION=1). In the event there is not intervention in the market, both pricing and physical runs correspond to INTERVENTION=0
SS_SOLAR_UIGF	Number(15,5)		Regional aggregated Unconstrained Intermittent Generation Forecast of Semi-scheduled generation (MW) where the primary fuel source is solar
SS_WIND_UIGF	Number (15,5)		Regional aggregated Unconstrained Intermittent Generation Forecast of Semi-scheduled generation (MW) where the primary fuel source is wind
SS_SOLAR_CLEAREDMW	Number(15,5)		Regional aggregated Semi-Schedule generator Cleared MW where the primary fuel source is solar
SS_WIND_CLEAREDMW	Number(15,5)		Regional aggregated Semi-Schedule generator Cleared MW where the primary fuel source is wind
SS_SOLAR_COMPLIANCEMW	Number(15,5)		Regional aggregated Semi-Schedule generator Cleared MW where Semi-Dispatch cap is enforced and the primary fuel source is solar
SS_WIND_COMPLIANCEMW	Number(15,5)		Regional aggregated Semi-Schedule generator Cleared MW

W			where Semi-Dispatch cap is enforced and the primary fuel source is wind
---	--	--	---

21.9 Table: P5MIN_UNITSOLUTION

21.9.1 P5MIN_UNITSOLUTION

Name P5MIN_UNITSOLUTION

Comment The five-minute predispach (P5Min) is a MMS system providing projected dispatch for 12 Dispatch cycles (one hour). The 5-minute Predispach cycle runs every 5-minutes to produce a dispatch and pricing schedule to a 5-minute resolution covering the next hour, a total of twelve periods.

P5MIN_UNITSOLUTION shows the Unit results from the capacity evaluations for each period of the study.

21.9.2 Description

P5MIN_UNITSOLUTION data is confidential, so shows own details for participant.

Source

P5MIN_UNITSOLUTION updates every 5 minutes for all units, even zero targets.

Volume

Rows per day: 57600

Based on 200 units per Interval

Note

A bitwise flag exists for each ancillary service type such that a unit trapped or stranded in one or more service type can be immediately identified. The SPD Formulation document details the logic determining whether a unit is "trapped" or "stranded". The flag is defined as follows:

Flagged Condition	Bit	Description	Field value
FCAS profile active	0	The bid profile for this service has been activated such that the unit is available to be cleared to provide this ancillary service type.	1 or 3
Trapped	1	The unit is enabled to provide this ancillary service type, however the profile for this service type is causing the unit to be trapped in the energy market.	3
Stranded	2	The unit is bid available to provide this ancillary service type, however, the unit is operating in the energy market outside of the profile for this service type and is stranded from providing this service.	4

21.9.3 Notes

Name Comment Value

Visibility Data in this table is: Private

21.9.4 Primary Key Columns

Name

DUID

INTERVAL_DATETIME

RUN_DATETIME

21.9.5 Index Columns

Name

LASTCHANGED

21.9.6 Content

Name	Data Type	Mandatory	Comment
RUN_DATETIME	DATE	X	Unique Timestamp Identifier for this study
INTERVAL_DATETIME	DATE	X	The unique identifier for the interval within this study
DUID	VARCHAR2(10)	X	Dispatchable unit identifier
CONNECTIONPOINTID	VARCHAR2(12)		Connection point identifier for DUID
TRADETYPE	NUMBER(2,0)		Generator or Load
AGCSTATUS	NUMBER(2,0)		AGC Status from EMS: 1 = on, 0 = off

INITIALMW	NUMBER(15,5)		Initial MW at start of period. For periods subsequent to the first period of a P5MIN run, this value represents the cleared target for the previous period of that P5MIN run.
TOTALCLEARED	NUMBER(15,5)		Target MW for end of period
RAMPDOWNRATE	NUMBER(15,5)		Ramp down rate (lessor of bid or telemetered rate).
RAMPUPRATE	NUMBER(15,5)		Ramp up rate (lessor of bid or telemetered rate).
LOWER5MIN	NUMBER(15,5)		Lower 5 min reserve target
LOWER60SEC	NUMBER(15,5)		Lower 60 sec reserve target
LOWER6SEC	NUMBER(15,5)		Lower 6 sec reserve target
RAISE5MIN	NUMBER(15,5)		Raise 5 min reserve target
RAISE60SEC	NUMBER(15,5)		Raise 60 sec reserve target
RAISE6SEC	NUMBER(15,5)		Raise 6 sec reserve target
LOWERREG	NUMBER(15,5)		Lower Regulation reserve target
RAISEREG	NUMBER(15,5)		Raise Regulation reserve target
AVAILABILITY	NUMBER(15,5)		Energy Availability (MW)
RAISE6SECFLAGS	NUMBER(3,0)		Raise 6sec status flag
RAISE60SECFLAGS	NUMBER(3,0)		Raise 60sec status flag
RAISE5MINFLAGS	NUMBER(3,0)		Raise 5min status flag
RAISEREGFLAGS	NUMBER(3,0)		Raise Reg status flag
LOWER6SECFLAGS	NUMBER(3,0)		Lower 6sec status flag

LOWER60SECFLAGS	NUMBER(3,0)		Lower 60sec status flag
LOWER5MINFLAGS	NUMBER(3,0)		Lower 5min status flag
LOWERREGFLAGS	NUMBER(3,0)		Lower Reg status flag
LASTCHANGED	DATE		Last date and time record changed
SEMIDISPATCHCAP	NUMBER(3,0)		Boolean representation flagging if the Target is Capped
INTERVENTION	Number(2,0)		Flag to indicate if this result set was sourced from the pricing run (INTERVENTION=0) or the physical run(INTERVENTION=1). In the event there is not intervention in the market, both pricing and physical runs correspond to INTERVENTION=0

22 Package: PARTICIPANT_REGISTRATION

Name PARTICIPANT_REGISTRATION

Comment Participant registration data

22.1 List of tables

Name	Comment
BIDDUIDDETAILS	BIDDUIDDETAILS and the associated tracking object BIDDUIDDETAILSTRK define the registration data for each ancillary service a dispatchable unit is registered to provide. The registration data is required to validate a dispatchable unit bid submitted for that ancillary service.
BIDDUIDDETAILSTRK	BIDDUIDDETAILSTRK shows the tracking for the associated object BIDDUIDDETAILS. Together, BIDDUIDDETAILSTRK and BIDDUIDDETAILS define the registration data for each ancillary service a dispatchable unit is registered to provide. The registration data is required to validate a dispatchable unit bid submitted for that ancillary service.
DISPATCHABLEUNIT	DISPATCHABLEUNIT sets out the unit name and type of each dispatchable unit in the market.
DUALLOC	DUALLOC cross references dispatch unit identifier to genset ID for each participant.
DUDETAIL	DUDETAIL sets out a records specific details for each unit including start type and whether normally on or off load. Much of this data is information only and is not used in dispatch or settlements.
DUDETAILSUMMARY	DUDETAILSUMMARY sets out a single summary unit table so reducing the need for participants to use the various dispatchable unit detail and owner tables to establish generating unit specific details.

GENMETER	GENMETER shows details of generator meter sets.
GENUNITS	GENUNITS shows Genset details for each physical unit with the relevant station.
GENUNITS_UNIT	Physical units within a Gen Unit Set
MNSP_INTERCONNECTOR	MNSP_INTERCONNECTOR sets out attributes of each interconnector.
MNSP_PARTICIPANT	MNSP_PARTICIPANT registers MNSP ownership.
PARTICIPANT	PARTICIPANT sets out Participant ID, name and class for all participants.
PARTICIPANTACCOUNT	PARTICIPANTACCOUNT shows financial details on participants.
PARTICIPANTCATEGORY	PARTICIPANTCATEGORY sets out valid participant categories.
PARTICIPANTCATEGORYALLOC	PARTICIPANTCATEGORYALLOC sets out the assignment of participants to particular categories.
PARTICIPANTCLASS	PARTICIPANTCLASS sets out valid participant classifications.
PARTICIPANTCREDITDETAIL	
STADUALLOC	STADUALLOC sets out details on the allocation of dispatchable units to particular sites or stations.
STATION	STATION sets out valid station identifiers.
STATIONOPERATINGSTATUS	STATIONOPERATINGSTATUS sets out the operating status of each station.
STATIONOWNER	STATIONOWNER sets out the owner details of each station.
STATIONOWNERTRK	STATIONOWNERTRK shows the tracking for the

	associated object STATIONOWNER. Together, STATIONOWNERTRK and STATIONOWNER sets out the owner details of each station.
--	--

22.2 Diagram: Entities: Participant Registration

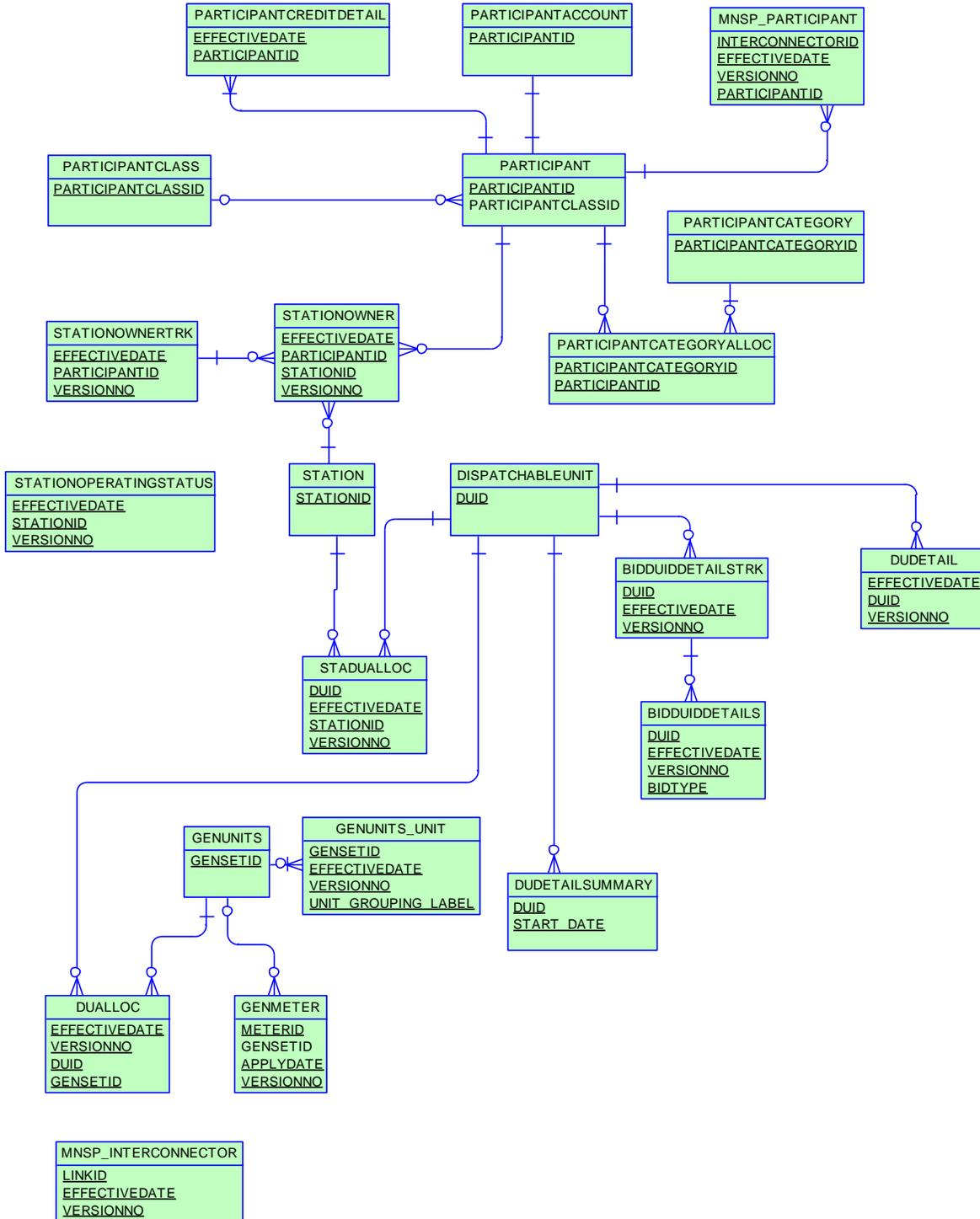

22.3 Table: BIDDUIDDETAILS

22.3.1 BIDDUIDDETAILS

Name	BIDDUIDDETAILS
Comment	BIDDUIDDETAILS and the associated tracking object BIDDUIDDETAILSTRK define the registration data for each ancillary service a dispatchable unit is registered to provide. The registration data is required to validate a dispatchable unit bid submitted for that ancillary service.

22.3.2 Description

BIDDUIDDETAILS data is public to participants.

Source

BIDDUIDDETAILS updates as dispatchable unit registration details are modified.

Volume

Approximately 1000 records per year.

22.3.3 Notes

Name	Comment	Value
Visibility	Data in this table is:	Public

22.3.4 Primary Key Columns

- Name
- BIDTYPE
- DUID
- EFFECTIVEDATE
- VERSIONNO

22.3.5 Index Columns

Name

LASTCHANGED

22.3.6 Content

Name	Data Type	Mandatory	Comment
DUID	VARCHAR2(10)	X	Dispatchable unit identifier
EFFECTIVEDATE	DATE	X	Market date starting at 04:30 inclusive
VERSIONNO	NUMBER(3,0)	X	Record version number
BIDTYPE	VARCHAR2(10)	X	Bid Type Identifier
MAXCAPACITY	NUMBER(22,0)		Maximum Capacity of this DUID for this BIDTYPE
MINENABLEMENTLEVEL	NUMBER(22,0)		Minimum Energy Output (MW) at which this ancillary service becomes available (AS Only)
MAXENABLEMENTLEVEL	NUMBER(22,0)		Maximum Energy Output (MW) at which this ancillary service can be supplied (AS Only)
MAXLOWERANGLE	NUMBER(3,0)		Maximum Angle at the lower end of the ancillary service profile (Degrees)
MAXUPPERANGLE	NUMBER(3,0)		Maximum Angle at the upper end of the ancillary service profile (Degrees)
LASTCHANGED	DATE		Last date and time record changed

22.4 Table: BIDDUIDDETAILSTRK

22.4.1 BIDDUIDDETAILSTRK

Name	BIDDUIDDETAILSTRK
Comment	BIDDUIDDETAILSTRK shows the tracking for the associated object BIDDUIDDETAILS. Together, BIDDUIDDETAILSTRK and BIDDUIDDETAILS define the registration data for each ancillary service a dispatchable unit is registered to provide. The registration data is required to validate a dispatchable unit bid submitted for that ancillary service.

22.4.2 Description

BIDDUIDDETAILSTRK data is public to participants.

Source

BIDDUIDDETAILSTRK updates as dispatchable unit registration details are modified.

Volume

Approximately 200 records per year

22.4.3 Notes

Name	Comment	Value
Visibility	Data in this table is:	Public

22.4.4 Primary Key Columns

- Name
- DUID
- EFFECTIVEDATE
- VERSIONNO

22.4.5 Index Columns

Name

LASTCHANGED

22.4.6 Content

Name	Data Type	Mandatory	Comment
DUID	VARCHAR2(10)	X	Dispatchable unit identifier
EFFECTIVEDATE	DATE	X	Market date starting at 04:30 inclusive
VERSIONNO	NUMBER(3,0)	X	Record version number
AUTHORISEDDATE	DATE		Date of record authorisation. A NULL value indicates the record is not authorised.
AUTHORISEDBY	VARCHAR2(15)		User that authorised record. A NULL value indicates the record is not authorised.
LASTCHANGED	DATE		Last date and time record changed

22.5 Table: DISPATCHABLEUNIT

22.5.1 DISPATCHABLEUNIT

Name	DISPATCHABLEUNIT
Comment	DISPATCHABLEUNIT sets out the unit name and type of each dispatchable unit in the market.

22.5.2 Description

DISPATCHABLEUNIT data is public data, and is available to all participants.

Source

DISPATCHABLEUNIT updates as new units added or names changed.

22.5.3 Notes

Name	Comment	Value
Visibility	Data in this table is:	Public

22.5.4 Primary Key Columns

Name
DUID

22.5.5 Index Columns

Name
LASTCHANGED

22.5.6 Content

Name	Data Type	Mandatory	Comment
------	-----------	-----------	---------

DUID	VARCHAR2(10)	X	Dispatchable Unit Identifier
DUNAME	VARCHAR2(20)		Dispatchable Unit full description
UNITTYPE	VARCHAR2(20)		Generation or Load
LASTCHANGED	DATE		Last date and time record changed

22.6 Table: DUALLOC

22.6.1 DUALLOC

Name	DUALLOC
Comment	DUALLOC cross references dispatch unit identifier to genset ID for each participant.

22.6.2 Description

Source

DUALLOC updates where changed.

22.6.3 Notes

Name	Comment	Value
Visibility	Data in this table is:	Private

22.6.4 Primary Key Columns

Name
 DUID
 EFFECTIVEDATE
 GENSETID
 VERSIONNO

22.6.5 Index Columns

Name
 LASTCHANGED

22.6.6 Index Columns

Name

DUID

22.6.7 Content

Name	Data Type	Mandatory	Comment
EFFECTIVEDATE	DATE	X	Effective calendar date of record
VERSIONNO	NUMBER(3,0)	X	Version no of record
DUID	VARCHAR2(10))	X	Dispatchable Unit identifier
GENSETID	VARCHAR2(20))	X	Physical unit identifier
LASTCHANGED	DATE		Last date and time record changed

22.7 Table: DUDETAIL

22.7.1 DUDETAIL

Name	DUDETAIL
Comment	DUDETAIL sets out a records specific details for each unit including start type and whether normally on or off load. Much of this data is information only and is not used in dispatch or settlements.

22.7.2 Description

DUDETAIL is public data, and is available to all participants.

Source

DUDETAIL updates only when registration details change.

Note

To find the current set of details for selected dispatchable units, query the participant's local database as follows.

```
Select du.* from dudetail du
where (du.EFFECTIVEDATE, du.VERSIONNO) =
(
select effectivedate, max(versionno)
from dudetail
where EFFECTIVEDATE = (select max(effectivedate)
from dudetail
where EFFECTIVEDATE <= sysdate
and duid = du.duid
and authoriseddate is not null)
and duid = du.duid
and authoriseddate is not null
group by effectivedate
)
and du.duid in ('UNIT1', 'UNIT2')
;
```

The following notes apply to this SQL code:

- This table is specific to dispatch units only.
- If you wish to query details for a different date, substitute a date expression for "sysdate" in the "where EFFECTIVEDATE <= sysdate" clause.
- If you wish to list all the units, remove the line "and du.duid in ('UNIT1', 'UNIT2')"
- The DUDETAIL table does not indicate if a unit is active; this is done through ownership (STADUALLOC) by an active station owned by an active participant (STATIONOWNER)
- If you wish to query Station details refer to STATION, STATIONOWNER and STADUALLOC.
- If you wish to look at connection point loss factors, refer to TRANSMISSIONLOSSFACTOR.

22.7.3 Notes

Name	Comment	Value
Visibility	Data in this table is:	Public

22.7.4 Primary Key Columns

Name

DUID

EFFECTIVEDATE

VERSIONNO

22.7.5 Index Columns

Name

LASTCHANGED

22.7.6 Content

Name	Data Type	Mandatory	Comment
EFFECTIVEDATE	DATE	X	Effective calendar date of record
DUID	VARCHAR2(10))	X	Dispatchable Unit Identifier
VERSIONNO	NUMBER(3,0)	X	version of Dispatchable Unit details for this effective date
CONNECTIONPOINTID	VARCHAR2(10))		Country wide - Unique id of a connection point
VOLTLEVEL	VARCHAR2(10))		Voltage Level

REGISTEREDCAPACITY	NUMBER(6,0)		Registered capacity for normal operations
AGCCAPABILITY	VARCHAR2(1)		AGC Capability flag
DISPATCHTYPE	VARCHAR2(10)		Identifies LOAD or GENERATOR
MAXCAPACITY	NUMBER(6,0)		Maximum Capacity as used for bid validation
STARTTYPE	VARCHAR2(20)		Identify unit as Fast or Slow
NORMALLYONFLAG	VARCHAR2(1)		For a dispatchable load indicates that the load is normally on or off.
PHYSICALDETAILSFLAG	VARCHAR2(1)		Indicates that the physical details for this unit are to be recorded
SPINNINGRESERVEFLAG	VARCHAR2(1)		Indicates spinning reserve capability
AUTHORISED BY	VARCHAR2(15)		User authorising record
AUTHORISED DATE	DATE		Date record authorised
LASTCHANGED	DATE		Last date and time record changed
INTERMITTENTFLAG	VARCHAR(1)		Indicate whether a unit is intermittent (e.g. a wind farm)
SemiSchedule_Flag	VARCHAR2(1)		Indicates if the DUID is a Semi-Scheduled Unit
MAXRATEOFCHANGEUP	Number(6,0)		Maximum ramp up rate for Unit (Mw/min)
MAXRATEOFCHANGEDOWN	Number(6,0)		Maximum ramp down rate for Unit (Mw/min)

22.8 Table: DUDETAILSUMMARY

22.8.1 DUDETAILSUMMARY

Name	DUDETAILSUMMARY
Comment	DUDETAILSUMMARY sets out a single summary unit table so reducing the need for participants to use the various dispatchable unit detail and owner tables to establish generating unit specific details.

22.8.2 Description

DUDETAILSUMMARY is a public table, and is available to all participants.

Source

DUDETAILSUMMARY updates only when registration details change.

22.8.3 Notes

Name	Comment	Value
Visibility	Data in this table is:	Public

22.8.4 Primary Key Columns

Name
 DUID
 START_DATE

22.8.5 Index Columns

Name
 LASTCHANGED

22.8.6 Content

Name	Data Type	Mandatory	Comment
DUID	VARCHAR2(10)	X	Dispatchable Unit Identifier
START_DATE	DATE	X	Start date for effective record
END_DATE	DATE	X	End date for effective record
DISPATCHTYPE	VARCHAR2(10)		Either Generator or Load
CONNECTIONPOINTID	VARCHAR2(10)		Country wide - Unique id of a connection point
REGIONID	VARCHAR2(10)		Region identifier that unit is in
STATIONID	VARCHAR2(10)		Station that unit is in
PARTICIPANTID	VARCHAR2(10)		Participant that owns unit during effective record period
LASTCHANGED	DATE		Last date and time record changed
TRANSMISSIONLOSSFACTOR	NUMBER(15,5)		The transmission level loss factor for currently assigned connection point
STARTTYPE	VARCHAR2(20)		Unit start type. At this time restricted to Fast, Slow or Non Dispatched
DISTRIBUTIONLOSSFACTOR	NUMBER(15,5)		The distribution loss factor to the currently assigned connection point
MINIMUM_ENERGY_PRICE	NUMBER(9,2)		Floored Offer/Bid Energy Price adjusted for TLF, DLF and MPF

MAXIMUM_ENERGY_PRICE	NUMBER(9,2)		Capped Offer/Bid Energy Price adjusted for TLF, DLF and VoLL
SCHEDULE_TYPE	VARCHAR2(20)		Scheduled status of the unit: 'SCHEDULED' 'NON-SCHEDULED' 'SEMI-SCHEDULED'
MIN_RAMP_RATE_UP	number(6,0)		MW/Min. Calculated Minimum Ramp Rate Up value accepted for Energy Offers or Bids with explanation
MIN_RAMP_RATE_DOWN	number(6,0)		MW/Min. Calculated Minimum Ramp Rate Down value accepted for Energy Offers or Bids with explanation
MAX_RAMP_RATE_UP	number(6,0)		Maximum ramp up rate for Unit (Mw/min) - from DUDetail table
MAX_RAMP_RATE_DOWN	number(6,0)		Maximum ramp down rate for Unit (Mw/min) - from DUDetail table
IS_AGGREGATED	NUMBER(1,0)		Whether the DUID is classified as an "Aggregated Unit" under the rules. This impacts the Minimum Ramp Rate calculation

22.9 Table: GENMETER

22.9.1 GENMETER

Name	GENMETER
Comment	GENMETER shows details of generator meter sets.

22.9.2 Description

GENMETER data is confidential to the relevant participant.

Source

GENMETER updates only when meter details change.

22.9.3 Notes

Name	Comment	Value
Visibility	Data in this table is:	Public

22.9.4 Primary Key Columns

- Name
- APPLYDATE
- METERID
- VERSIONNO

22.9.5 Index Columns

- Name
- LASTCHANGED

22.9.6 Index Columns

Name

STATIONID

22.9.7 Content

Name	Data Type	Mandatory	Comment
METERID	VARCHAR2(12)	X	Meter Id
GENSETID	VARCHAR2(20)		Generator Set ID
CONNECTIONPOINTID	VARCHAR2(10)		Not used
STATIONID	VARCHAR2(10)		Station Identifier
METERTYPE	VARCHAR2(20)		LOAD
METERCLASS	VARCHAR2(10)		WATT or AUXILARY
VOLTAGELEVEL	NUMBER(6,0)		Voltage
APPLYDATE	DATE	X	Application date
VERSIONNO	NUMBER(3,0)	X	Version no of the record for the given effective date
AUTHORISED BY	VARCHAR2(10)		AEMO user authorising
AUTHORISED DATE	DATE		Date authorised
COMDATE	DATE		Not used

DECOMDATE	DATE		Not used
ENDDATE	DATE		Not used
STARTDATE	DATE		Not used
LASTCHANGED	DATE		Last date and time record changed

22.10 Table: GENUNITS

22.10.1 GENUNITS

Name	GENUNITS
Comment	GENUNITS shows Genset details for each physical unit with the relevant station.

22.10.2 Description

GENUNITS data is confidential to the relevant participant.

Source

GENUNITS updates whenever plant details change.

22.10.3 Notes

Name	Comment	Value
Visibility	Data in this table is:	Public

22.10.4 Primary Key Columns

Name
GENSETID

22.10.5 Index Columns

Name
LASTCHANGED

22.10.6 Content

Name	Data Type	Mandatory	Comment
GENSETID	VARCHAR2(20))	X	Physical Unit identifier
STATIONID	VARCHAR2(10))		Station Identifier
SETLOSSFACTOR	NUMBER(16,6)		Not used
CDINDICATOR	VARCHAR2(10))		Centrally dispatched Indicator
AGCFLAG	VARCHAR2(2)		AGC Available flag
SPINNINGFLAG	VARCHAR2(2)		Not used
VOLTLEVEL	NUMBER(6,0)		Voltage level
REGISTEREDCAPACITY	NUMBER(6,0)		Registered capacity
DISPATCHTYPE	VARCHAR2(10))		Scheduled indicator
STARTTYPE	VARCHAR2(20))		Fast / Slow / Not Dispatched
MKTGENERATORIND	VARCHAR2(10))		Market Generator Indicator Flag
NORMALSTATUS	VARCHAR2(10))		On / Off for load
MAXCAPACITY	NUMBER(6,0)		Maximum capacity
GENSETTYPE	VARCHAR2(15))		Genset type
GENSETNAME	VARCHAR2(40))		Genset name

LASTCHANGED	DATE		Last date and time record changed
CO2E_EMISSIONS_FACTOR	NUMBER(18,8)		The emissions factor for the generating unit, as calculated by Settlements staff members
CO2E_ENERGY_SOURCE	VARCHAR2(100)		The energy source for the generating unit, as used in the calculation of the CO2-e emissions factor. Distinct from the Energy Source for a generating unit published as part of the Registration Master List
CO2E_DATA_SOURCE	VARCHAR2(20)		An indicator as to the source of the emission factor used in the calculation of the index. The applicable values for this field would be NTNDP which indicates the emission factor is quoted from the National Transmission Network Development Plan or Estimated to indicate the emission factor has been calculated using an internal AEMO procedure based upon the Department of Climate Change and Energy Efficiency NGA factors

22.11 Table: GENUNITS_UNIT

22.11.1 GENUNITS_UNIT

Name	GENUNITS_UNIT
Comment	Physical units within a Gen Unit Set

22.11.2 Notes

Name	Comment	Value
Visibility	Data in this table is:	Public

22.11.3 Primary Key Columns

Name

EFFECTIVEDATE

GENSETID

UNIT_GROUPING_LABEL

VERSIONNO

22.11.4 Index Columns

Name

GENSETID

EFFECTIVEDATE

VERSIONNO

UNIT_GROUPING_LABEL

22.11.5 Content

Name	Data Type	Mandatory	Comment
GENSETID	VARCHAR2(20)	X	System wide unique Generating Set ID
EFFECTIVEDATE	DATE	X	Effective Date of this detail record
VERSIONNO	NUMBER(6,0)	X	Version with respect to the effective date
UNIT_GROUPING_LABEL	VARCHAR2(20)	X	Label of Physical Units within the station
UNIT_COUNT	NUMBER(3,0)		Number of units in this Gen Unit grouping
UNIT_SIZE	NUMBER(8,3)		Nameplate Capacity for each unit in this grouping
UNIT_MAX_SIZE	NUMBER(8,3)		Maximum Capacity for each unit in this grouping
AGGREGATION_FLAG	NUMBER(1,0)		Indicator that Unit is part of an Aggregated Unit (at the DUID level)
LASTCHANGED	DATE		Date/Time when record was changed

22.12 Table: MNSP_INTERCONNECTOR

22.12.1 MNSP_INTERCONNECTOR

Name	MNSP_INTERCONNECTOR
Comment	MNSP_INTERCONNECTOR sets out attributes of each interconnector.

22.12.2 Description

MNSP_INTERCONNECTOR data is public, so is available to all participants.

Source

MNSP_INTERCONNECTOR changes infrequently, typically annually.

Volume

Twice the number of MNSPs.

22.12.3 Notes

Name	Comment	Value
Visibility	Data in this table is:	Public

22.12.4 Primary Key Columns

Name

EFFECTIVEDATE

LINKID

VERSIONNO

22.12.5 Index Columns

Name

LASTCHANGED

22.12.6 Content

Name	Data Type	Mandatory	Comment
LINKID	VARCHAR2(10)	X	Identifier for each of the two MNSP Interconnector Links. Each link pertains to the direction from and to.
EFFECTIVEDATE	DATE	X	Date when Interconnector becomes effective
VERSIONNO	NUMBER(3,0)	X	Version of data for other key data - a higher version for same key data will take precedence
INTERCONNECTORID	VARCHAR2(10)		Interconnector Identifier
FROMREGION	VARCHAR2(10)		Nominated source region for Interconnector
TOREGION	VARCHAR2(10)		Nominated destination region for Interconnector
MAXCAPACITY	NUMBER(5,0)		Maximum capacity
TLF	NUMBER(12,7)		Transmission Loss Factor (redundant from May 2012)
LHSFACTOR	NUMBER(12,7)		Factor applied to the LHS of constraint equations; set by AEMO
METERFLOWCONSTANT	NUMBER(12,7)		Obsolete; no longer applied. Ignore.
AUTHORISEDDATE	DATE		Date of authorisation. Nominal date but required to enable Interconnector.

AUTHORISEDBY	VARCHAR2(15))		Authorising officer
LASTCHANGED	DATE		Last date and time record changed
FROM_REGION_TLF	NUMBER(12,7)		Transmission Loss Factor for Link "From Region" end
TO_REGION_TLF	NUMBER(12,7)		Transmission Loss Factor for Link at "To Region" end

22.13 Table: MNSP_PARTICIPANT

22.13.1 MNSP_PARTICIPANT

Name	MNSP_PARTICIPANT
Comment	MNSP_PARTICIPANT registers MNSP ownership.

22.13.2 Description

MNSP_PARTICIPANT data is public, so is available to all participants.

Source

MNSP_PARTICIPANT updates infrequently, typically annually.

Volume

Number of MNSPs.

22.13.3 Notes

Name	Comment	Value
Visibility	Data in this table is:	Public

22.13.4 Primary Key Columns

- Name
- EFFECTIVEDATE
- INTERCONNECTORID
- PARTICIPANTID
- VERSIONNO

22.13.5 Index Columns

- Name

LASTCHANGED

22.13.6 Content

Name	Data Type	Mandatory	Comment
INTERCONNECTORID	VARCHAR2(10)	X	Interconnector Identifier
EFFECTIVEDATE	DATE	X	Calendar date when Interconnector ownership becomes effective
VERSIONNO	NUMBER(3,0)	X	Version of data for other key data - a higher version for same key data takes precedence
PARTICIPANTID	VARCHAR2(10)	X	Participant Identifier
LASTCHANGED	DATE		Last date and time record changed

22.14 Table: PARTICIPANT

22.14.1 PARTICIPANT

Name	PARTICIPANT
Comment	PARTICIPANT sets out Participant ID, name and class for all participants.

22.14.2 Description

PARTICIPANT is public data, so is available to all participants.

Source

PARTICIPANT updates as new participants register or existing participants change details.

22.14.3 Notes

Name	Comment	Value
Visibility	Data in this table is:	Public

22.14.4 Primary Key Columns

Name
PARTICIPANTID

22.14.5 Index Columns

Name
LASTCHANGED

22.14.6 Content

Name	Data Type	Mandatory	Comment

PARTICIPANTID	VARCHAR2(10)	X	Unique participant identifier
PARTICIPANTCLASSID	VARCHAR2(20)		Class of participant
NAME	VARCHAR2(80)		Full name of participant
DESCRIPTION	VARCHAR2(64)		Not used
ACN	VARCHAR2(9)		Australian Company Number; Nine Numbers XXX-XXX-XXX
PRIMARYBUSINESS	VARCHAR2(40)		Identifies primary business activity of participant
LASTCHANGED	DATE		Last date and time record changed

22.15 Table: PARTICIPANTACCOUNT

22.15.1 PARTICIPANTACCOUNT

Name PARTICIPANTACCOUNT

Comment PARTICIPANTACCOUNT shows financial details on participants.

22.15.2 Description

PARTICIPANTACCOUNT data is confidential to the relevant participant.

Source

PARTICIPANTACCOUNT updates as new participants register or existing participants change details.

22.15.3 Notes

Name	Comment	Value
Visibility	Data in this table is:	Private

22.15.4 Primary Key Columns

Name

PARTICIPANTID

22.15.5 Index Columns

Name

LASTCHANGED

22.15.6 Content

Name	Data Type	Mandatory	Comment
ACCOUNTNAME	VARCHAR2(80)		Name of the account

)		
PARTICIPANTID	VARCHAR2(10))	X	Unique participant identifier
ACCOUNTNUMBER	VARCHAR2(16))		Account number
BANKNAME	VARCHAR2(16))		Bank name
BANKNUMBER	NUMBER(10,0)		Bank number
BRANCHNAME	VARCHAR2(16))		Branch name
BRANCHNUMBER	NUMBER(10,0)		Branch number
BSBNUMBER	VARCHAR2(20))		BSB number
NEMMCO CREDIT ACCOUNT NUMBER	NUMBER(10,0)		AEMO credit account number
NEMM CODEBIT ACCOUNT NUMBER	NUMBER(10,0)		AEMO debit account number
AUTHORISED BY	VARCHAR2(15))		User authorising record
AUTHORISED DATE	DATE		Authorised date
EFFECTIVE DATE	DATE		Date record authorised
LAST CHANGED	DATE		Last date and time record changed
ABN	VARCHAR2(20))		Australian Business Number

22.16 Table: PARTICIPANTCATEGORY

22.16.1 PARTICIPANTCATEGORY

Name PARTICIPANTCATEGORY

Comment PARTICIPANTCATEGORY sets out valid participant categories.

22.16.2 Description

PARTICIPANTCATEGORY is public data, so is available to all participants.

Source

PARTICIPANTCATEGORY updates as categories change. PARTICIPANTCATEGORY changes infrequently.

22.16.3 Notes

Name	Comment	Value
Visibility	Data in this table is:	Public

22.16.4 Primary Key Columns

Name

PARTICIPANTCATEGORYID

22.16.5 Index Columns

Name

LASTCHANGED

22.16.6 Content

Name	Data Type	Mandatory	Comment
------	-----------	-----------	---------

PARTICIPANTCATEGORYID	VARCHAR2(10)	X	Participant category identifier
DESCRIPTION	VARCHAR2(64)		Category description
LASTCHANGED	DATE		Last date and time record changed

22.17 Table: PARTICIPANTCATEGORYALLOC

22.17.1 PARTICIPANTCATEGORYALLOC

Name	PARTICIPANTCATEGORYALLOC
Comment	PARTICIPANTCATEGORYALLOC sets out the assignment of participants to particular categories.

22.17.2 Description

PARTICIPANTCATEGORYALLOC data is public, so is available to all participants.

Source

PARTICIPANTCATEGORYALLOC updates for new participants or when categories change. PARTICIPANTCATEGORYALLOC changes infrequently.

22.17.3 Notes

Name	Comment	Value
Visibility	Data in this table is:	Public

22.17.4 Primary Key Columns

Name
PARTICIPANTCATEGORYID
PARTICIPANTID

22.17.5 Index Columns

Name
LASTCHANGED

22.17.6 Content

Name	Data Type	Mandatory	Comment
PARTICIPANTCATEGORYID	VARCHAR2(10))	X	Category unique identifier
PARTICIPANTID	VARCHAR2(10))	X	Unique participant identifier
LASTCHANGED	DATE		Last date and time record changed

22.18 Table: PARTICIPANTCLASS

22.18.1 PARTICIPANTCLASS

Name PARTICIPANTCLASS

Comment PARTICIPANTCLASS sets out valid participant classifications.

22.18.2 Description

PARTICIPANTCLASS data is public, so is available to all participants.

Source

PARTICIPANTCLASS updates only if classifications change. This table changes infrequently.

22.18.3 Notes

Name	Comment	Value
Visibility	Data in this table is:	Public

22.18.4 Primary Key Columns

Name

PARTICIPANTCLASSID

22.18.5 Index Columns

Name

LASTCHANGED

22.18.6 Content

Name	Data Type	Mandatory	Comment
------	-----------	-----------	---------

PARTICIPANTCLASSID	VARCHAR2(20)	X	Class of participant
DESCRIPTION	VARCHAR2(64)		Description of participant class
LASTCHANGED	DATE		Last date and time record changed

22.19 Table: PARTICIPANTCREDITDETAIL

22.19.1 PARTICIPANTCREDITDETAIL

Name PARTICIPANTCREDITDETAIL
Comment

22.19.2 Description

PARTICIPANTCREDITDETAIL data is confidential to each participant.

Source

PARTICIPANTCREDITDETAIL updates infrequently.

22.19.3 Notes

Name	Comment	Value
Visibility	Data in this table is:	Private

22.19.4 Primary Key Columns

Name
EFFECTIVEDATE
PARTICIPANTID

22.19.5 Index Columns

Name
PARTICIPANTID

22.19.6 Index Columns

Name

LASTCHANGED

22.19.7 Content

Name	Data Type	Mandatory	Comment
EFFECTIVEDATE	DATE	X	
PARTICIPANTID	VARCHAR2(10)	X	
CREDITLIMIT	NUMBER(10,0)		
AUTHORISED BY	VARCHAR2(15)		
AUTHORISED DATE	DATE		
LASTCHANGED	DATE		Last date and time record changed

22.20 Table: STADUALLOC

22.20.1 STADUALLOC

Name	STADUALLOC
Comment	STADUALLOC sets out details on the allocation of dispatchable units to particular sites or stations.

22.20.2 Description

STADUALLOC is public data, and is available to all participants.

Source

STADUALLOC is updated whenever there is a station configuration change or new unit registration.

22.20.3 Notes

Name	Comment	Value
Visibility	Data in this table is:	Public

22.20.4 Primary Key Columns

Name
 DUID
 EFFECTIVEDATE
 STATIONID
 VERSIONNO

22.20.5 Index Columns

Name
 LASTCHANGED

22.20.6 Index Columns

Name
 STATIONID
 EFFECTIVEDATE
 VERSIONNO

22.20.7 Index Columns

Name
 DUID

22.20.8 Content

Name	Data Type	Mandatory	Comment
DUID	VARCHAR2(10)	X	Dispatchable Unit Identifier
EFFECTIVEDATE	DATE	X	Effective date of this record
STATIONID	VARCHAR2(10)	X	Station Identifier
VERSIONNO	NUMBER(3,0)	X	Version no of this record for the effective date
LASTCHANGED	DATE		Last date and time record changed

22.21 Table: STATION

22.21.1 STATION

Name STATION

Comment STATION sets out valid station identifiers.

22.21.2 Description

STATION is public data, and is available to all participants.

Source

STATION updates whenever there is a station configuration change or new unit registration.

22.21.3 Notes

Name	Comment	Value
Visibility	Data in this table is:	Public

22.21.4 Primary Key Columns

Name

STATIONID

22.21.5 Index Columns

Name

LASTCHANGED

22.21.6 Content

Name	Data Type	Mandatory	Comment
------	-----------	-----------	---------

STATIONID	VARCHAR2(10)	X	Station Identifier
STATIONNAME	VARCHAR2(80)		Full name of station
ADDRESS1	VARCHAR2(80)		Station Address
ADDRESS2	VARCHAR2(80)		Station Address
ADDRESS3	VARCHAR2(80)		Station Address
ADDRESS4	VARCHAR2(80)		Station Address
CITY	VARCHAR2(40)		City
STATE	VARCHAR2(10)		State of Australia
POSTCODE	VARCHAR2(10)		Post Code
LASTCHANGED	DATE		Last date and time record changed
CONNECTIONPOINTID	VARCHAR2(10)		Not used. Do not use as the Connection Point Identifier for station load

22.22 Table: STATIONOPERATINGSTATUS

22.22.1 STATIONOPERATINGSTATUS

Name	STATIONOPERATINGSTATUS
Comment	STATIONOPERATINGSTATUS sets out the operating status of each station.

22.22.2 Description

STATIONOWNER is public data, and is available to all participants.

Source

STATIONOWNER is updated whenever there is a change in the station owner or new units are registered.

22.22.3 Notes

Name	Comment	Value
Visibility	Data in this table is:	Public

22.22.4 Primary Key Columns

- Name
- EFFECTIVEDATE
- STATIONID
- VERSIONNO

22.22.5 Index Columns

- Name
- LASTCHANGED

22.22.6 Content

Name	Data Type	Mandatory	Comment
EFFECTIVEDATE	DATE	X	Effective date of this record
STATIONID	VARCHAR2(10)	X	Unique station identifier
VERSIONNO	NUMBER(3,0)	X	Version no of record within the effective date
STATUS	VARCHAR2(20)		The operating status of this station, valid values are COMMISSIONED and DECOMMISSIONED
AUTHORISED BY	VARCHAR2(15)		User authorising record
AUTHORISED DATE	DATE		Date record authorised
LASTCHANGED	DATE		Last date and time record changed

22.23 Table: STATIONOWNER

22.23.1 STATIONOWNER

Name	STATIONOWNER
Comment	STATIONOWNER sets out the owner details of each station.

22.23.2 Description

STATIONOWNER is public data, and is available to all participants.

Source

STATIONOWNER is updated whenever there is a change in the station owner or new units are registered.

22.23.3 Notes

Name	Comment	Value
Visibility	Data in this table is:	Public

22.23.4 Primary Key Columns

- Name
- EFFECTIVEDATE
- PARTICIPANTID
- STATIONID
- VERSIONNO

22.23.5 Index Columns

- Name
- LASTCHANGED

22.23.6 Index Columns

Name

STATIONID

EFFECTIVEDATE

VERSIONNO

22.23.7 Index Columns

Name

PARTICIPANTID

22.23.8 Content

Name	Data Type	Mandatory	Comment
EFFECTIVEDATE	DATE	X	Effective date of this record
PARTICIPANTID	VARCHAR2(10))	X	Unique participant identifier
STATIONID	VARCHAR2(10))	X	Station Identifier
VERSIONNO	NUMBER(3,0)	X	Version no of record within the effective date
LASTCHANGED	DATE		Last date and time record changed

22.24 Table: STATIONOWNERTRK

22.24.1 STATIONOWNERTRK

Name	STATIONOWNERTRK
Comment	STATIONOWNERTRK shows the tracking for the associated object STATIONOWNER. Together, STATIONOWNERTRK and STATIONOWNER sets out the owner details of each station.

22.24.2 Description

STATIONOWNER is public data, and is available to all participants.

Source

STATIONOWNER is updated whenever there is a change in the station owner or new units are registered.

22.24.3 Notes

Name	Comment	Value
Visibility	Data in this table is:	Public

22.24.4 Primary Key Columns

Name
EFFECTIVEDATE
PARTICIPANTID
VERSIONNO

22.24.5 Index Columns

Name
LASTCHANGED

22.24.6 Content

Name	Data Type	Mandatory	Comment
EFFECTIVEDATE	DATE	X	Effective date of this record
PARTICIPANTID	VARCHAR2(10)	X	Unique participant identifier
VERSIONNO	NUMBER(3,0)	X	Version no of record within the effective date
AUTHORISED BY	VARCHAR2(15)		User authorising record
AUTHORISED DATE	DATE		Date record authorised
LASTCHANGED	DATE		Last date and time record changed

23 Package: PRE_DISPATCH

<i>Name</i>	PRE_DISPATCH
<i>Comment</i>	Results from a published Predispatch Run

Storage options

There are 2 ways to define the Pre-dispatch table primary keys (PKs) to define which data is loaded to the database and which data is retained:

Option 1 (default)

Overwrite older records when they are succeeded by later versions for the same entity and period. This is the Data Model default and results in the consumption of far less storage. Data Model updates issued by AEMO target this configuration so participants implementing option 2a or 2b must maintain their changes when AEMO releases a new Data Model version.

PredispatchLoad: DateTime, DUID

PredispatchInterconnectorRes: DateTime, InterconnectorID,

PredispatchPrice: DateTime, RegionID

PredispatchPriceSensitivities: DateTime, RegionID

PredispatchInterSensitivities: InterconnectorID, DateTime

PredispatchRegionsum: DateTime, RegionID

Option 2a

Retain only the Pricing records for tables relating to Price data and Physical records for tables relating to Physical data (e.g. targets). Approximately 50 times more storage volumes than option 1.

PredispatchLoad: PredispatchSeqNo, DateTime, DUID

PredispatchInterconnectorRes: PredispatchSeqNo, DateTime, InterconnectorID,

PredispatchPrice: PredispatchSeqNo, DateTime, RegionID

PredispatchPriceSensitivities: PredispatchSeqNo, DateTime, RegionID

PredispatchInterSensitivities: PredispatchSeqNo, DateTime, InterconnectorID

PredispatchRegionsum: PredispatchSeqNo, DateTime, RegionID

Option 2b

Retain both Physical and Pricing data for Intervention runs. If Intervention

cases are stored in entirety, you must select the data carefully. The logic is the same as for Dispatch, i.e. Intervention Pricing is always where Intervention = 0 and Physical data is where Intervention = PredispatchCaseSolution.Intervention for the same PredispatchSeqNo.

Doubles the storage of option 2a but ONLY for Intervened cases.

PredispatchLoad: PredispatchSeqNo, Intervention, DateTime, DUID

PredispatchInterconnectorRes: PredispatchSeqNo, Intervention, DateTime, InterconnectorID,

PredispatchPrice: PredispatchSeqNo, Intervention, DateTime, RegionID

PredispatchPriceSensitivities: PredispatchSeqNo, Intervention, DateTime, RegionID

PredispatchInterSensitivities: PredispatchSeqNo, Intervention, DateTime, InterconnectorID

PredispatchRegionsum: PredispatchSeqNo, Intervention, DateTime, RegionID

Notes:

The data in the PredispatchIS file is always ordered so the pdrLoader writes the relevant data first and discards the subsequent irrelevant data, or writes the subsequent data, depending on how the PKs are defined.

You may order the PKs in a different order, depending on your local requirements. Any decision to change the PK column composition or order must consider the functional and performance impacts to existing applications or queries.

The pdrLoader caches PK definitions for performance reasons so any change to the PKs requires a restart of the application.

The TRANSACTION_TYPE default in the PDR_REPORT_RECORDS management tables for PREDISPATCH* tables is UPDATE-INSERT. You can modify this to INSERT for Option 2b, as the attempt to first perform an update becomes redundant. This can improve load performance.

23.1 List of tables

Name	Comment
PREDISPATCH_FCAS_REQ	PREDISPATCH_FCAS_REQ shows Predispatch Constraint tracking for Regional FCAS Requirements.

PREDISPATCH_LOCAL_PRICE	Sets out local pricing offsets associated with each DUID connection point for each dispatch period
PREDISPATCH_MNSPBIDTRK	PREDISPATCH_MNSPBIDTRK shows the MNSP bid tracking, including the bid version used in each predispatch run for each MNSP Interconnector Link. PREDISPATCH_MNSPBIDTRK shows the audit trail of the bid used for each predispatch run.
PREDISPATCHBLOCKEDCONSTRAINT	PREDISPATCH Blocked Constraints lists any constraints that were blocked in a Predispatch run. If no constraints are blocked, there will be no rows for that predispatch run.
PREDISPATCHCASESOLUTION	PREDISPATCHCASESOLUTION provides information relating to the complete predispatch run. The fields provide an overview of the dispatch run results allowing immediate identification of conditions such as energy or FCAS deficiencies.
PREDISPATCHCONSTRAINT	<p>PREDISPATCHCONSTRAINT sets out constraints that are binding in each predispatch run and interconnector constraints (whether binding or not). Only binding and interconnector constraints are reported. Binding contracts have marginal value greater than \$0. Interconnector constraints are listed so RHS values can be reported for ST PASA.</p> <p>Constraint solutions only report fixed loading /MR constraints on the next day.</p>
PREDISPATCHINTERCONNECTORRES	<p>PREDISPATCHINTERCONNECTORRES records Interconnector flows and losses for the periods calculated in each predispatch run. Only binding and interconnector constraints are reported.</p> <p>Some fields are for the Frequency Controlled Ancillary Services export and import limits and extra reporting of the generic constraint setting the energy import and export limits.</p>

PREDISPATCHINTERSENSITIVITIES	PREDISPATCHINTERSENSITIVITIES sets out the sensitivity flows for each interconnector by period.
PREDISPATCHLOAD	PREDISPATCHLOAD shows pre-dispatch targets for each dispatchable unit, including additional fields to handle the Ancillary Services functionality. No record is written where a unit is not dispatched. PREDISPATCHLOAD shows all the results for each period.
PREDISPATCHOFFERTRK	PREDISPATCHOFFERTRK is for the ancillary service bid tracking of predispach processing. PREDISPATCHOFFERTRK identifies which bids from BIDDAYOFFER and BIDPEROFFER were applied for a given unit and ancillary service for each predispach run.
PREDISPATCHPRICE	PREDISPATCHPRICE records predispach prices for each region by period for each predispach run, including fields to handle the Ancillary Services functionality.
PREDISPATCHPRICESENSITIVITIES	PREDISPATCHPRICESENSITIVITIES sets out the sensitivity prices for each region by period.
PREDISPATCHREGIONSUM	PREDISPATCHREGIONSUM sets out the overall regional Pre-Dispatch results for base case details (excluding price).
PREDISPATCHSCENARIODEMAND	PREDISPATCHSCENARIODEMAND defines the demand offsets that are applied for each of the predispach sensitivity scenarios.
PREDISPATCHSCENARIODEMANDTRK	Tracks the predispach scenario offset updates across time

23.2 Diagram: Entities: Predispatch

PREDISPATCCASESOLUTION
<u>PREDISPATCHSEQNO</u>
<u>RUNNO</u>

PREDISPATCHINTERCONNECTORRES
<u>INTERCONNECTORID</u>
<u>DATETIME</u>

PREDISPATCHLOAD
<u>DUID</u>
<u>DATETIME</u>

PREDISPATCHCONSTRAINT
<u>CONSTRAINTID</u>
<u>DATETIME</u>

PREDISPATCHPRICESENSITIVITIES
<u>REGIONID</u>
<u>DATETIME</u>

PREDISPATCHREGIONSUM
<u>REGIONID</u>
<u>DATETIME</u>

PREDISPATCCHOFFERTRK
<u>PREDISPATCHSEQNO</u>
<u>DUID</u>
<u>BIDTYPE</u>
<u>PERIODID</u>

PREDISPATCHPRICE
<u>REGIONID</u>
<u>DATETIME</u>

PREDISPATCH_MNSPBIDTRK
<u>PREDISPATCHSEQNO</u>
<u>LINKID</u>
<u>PERIODID</u>

PREDISPATCHSCENARIODEMAND
<u>EFFECTIVEDATE</u>
<u>VERSIONNO</u>
<u>SCENARIO</u>
<u>REGIONID</u>

PREDISPATCH_FCAS_REQ
<u>GENCONID</u>
<u>REGIONID</u>
<u>BIDTYPE</u>
<u>DATETIME</u>

PREDISPATCHINTERSENSITIVITIES
<u>INTERCONNECTORID</u>
<u>DATETIME</u>

PREDISPATCHSCENARIODEMANDTRK
<u>EFFECTIVEDATE</u>
<u>VERSIONNO</u>

PREDISPATCHBLOCKEDCONSTRAINT
<u>PREDISPATCHSEQNO</u>
<u>CONSTRAINTID</u>

PREDISPATCH_LOCAL_PRICE
<u>DATETIME</u>
<u>DUID</u>

23.3 Table: PREDISPATCH_FCAS_REQ

23.3.1 PREDISPATCH_FCAS_REQ

Name	PREDISPATCH_FCAS_REQ
Comment	PREDISPATCH_FCAS_REQ shows Predispatch Constraint tracking for Regional FCAS Requirements.

23.3.2 Description

Source

PREDISPATCH_FCAS_REQ updates with each pre-dispatch run (half hourly)

Volume

Approximately 2,000 rows per day.

Note

The PERIODID columns in tables PREDISPATCHCONSTRAINT and PREDISPATCH_FCAS_REQ have no consistent relationship with the other PERIODID values in the other tables in the PRE-DISPATCH package (such as PREDISPATCHPRICE). AEMO and many Participants appreciate the data model is inconsistent, but the cost of changing existing systems has been judged as being unjustifiable. An additional field DATETIME was added to allow joins between these data sets.

23.3.3 Notes

Name	Comment	Value
Visibility	Data in this table is:	Public

23.3.4 Primary Key Columns

- Name
- BIDTYPE
- DATETIME
- GENCONID
- REGIONID

23.3.5 Index Columns

Name

LASTCHANGED

23.3.6 Content

Name	Data Type	Mandatory	Comment
PREDISPATCHSEQNO	VARCHAR2(20)		PreDispatch Sequence number
RUNNO	NUMBER(3,0)		Case Run number
INTERVENTION	NUMBER(2,0)		Intervention Flag
PERIODID	VARCHAR2(20)		Unique period identifier, in the format yyymmddpp. The period (pp) is 01 to 48, with 01 corresponding to the half-hour ending at 04:30am.
GENCONID	VARCHAR2(20)	X	Generic Constraint ID - Join to table GenConData
REGIONID	VARCHAR2(10)	X	Region ID
BIDTYPE	VARCHAR2(10)	X	Bid Type Identifier
GENCONEFFECTIVEDATE	DATE		Generic Constraint EffectiveDate - Join to table GenConData
GENCONVERSIONNO	NUMBER(3,0)		Generic Constraint Version number - Join to table GenConData
MARGINALVALUE	NUMBER(16,6)		Marginal Value of generic

			constraint
DATETIME	DATE	X	Date and Time of trading interval
LASTCHANGED	DATE		Last date and time record changed
BASE_COST	NUMBER(18,8)		The base cost of the constraint for this service, before the regulation/contingency split
ADJUSTED_COST	NUMBER(18,8)		The adjusted cost of the constraint for this service, before the regulation/contingency split
ESTIMATED_CMPF	NUMBER(18,8)		An estimated value for the constraint CMPF, based on dispatched data
ESTIMATED_CRMPF	NUMBER(18,8)		An estimated value for the constraint CRMPF, based on dispatched data
RECOVERY_FACTOR_CMPF	NUMBER(18,8)		Estimated recovery factor for CMPF based recovery
RECOVERY_FACTOR_CRMPF	NUMBER(18,8)		Estimated recovery factor for CRMPF based recovery

23.4 Table: PREDISPATCH_LOCAL_PRICE

23.4.1 PREDISPATCH_LOCAL_PRICE

Name PREDISPATCH_LOCAL_PRICE

Comment Sets out local pricing offsets associated with each DUID connection point for each dispatch period

23.4.2 Notes

Name	Comment	Value
Visibility	Data in this table is:	Private; Public Next-Day

23.4.3 Primary Key Columns

Name

DATETIME

DUID

23.4.4 Index Columns

Name

DATETIME

DUID

23.4.5 Content

Name	Data Type	Mandatory	Comment
PREDISPATCHSEQNO	VARCHAR2(20)	X	Unique identifier of predispach run in the form YYYYMMDDPP with)

			01 at 04:30
DATETIME	DATE	X	The unique identifier for the interval within this study
DUID	VARCHAR2(20)	X	Dispatchable unit identifier
PERIODID	VARCHAR2(20)		A period count, starting from 1 for each predispach run. Use DATETIME to determine half hour period
LOCAL_PRICE_ADJUSTMENT	NUMBER(10,2)		Aggregate Constraint contribution cost of this unit: Sum(MarginalValue x Factor) for all relevant Constraints
LOCALLY_CONSTRAINED	NUMBER(1,0)		Key for Local_Price_Adjustment: 2 = at least one Outage Constraint; 1 = at least 1 System Normal Constraint (and no Outage Constraint); 0 = No System Normal or Outage Constraints
LASTCHANGED	DATE		Last date and time record changed

23.5 Table: PREDISPATCH_MNSPBIDTRK

23.5.1 PREDISPATCH_MNSPBIDTRK

Name	PREDISPATCH_MNSPBIDTRK
Comment	PREDISPATCH_MNSPBIDTRK shows the MNSP bid tracking, including the bid version used in each predispach run for each MNSP Interconnector Link. PREDISPATCH_MNSPBIDTRK shows the audit trail of the bid used for each predispach run.

23.5.2 Description

Source

Own (confidential) data updates every predispach run. All bids are available to all participants as part of next day market data.

Volume

1, 700, 000 per year

23.5.3 Notes

Name	Comment	Value
Visibility	Data in this table is:	Public

23.5.4 Primary Key Columns

- Name
- LINKID
- PERIODID
- PREDISPATCHSEQNO

23.5.5 Index Columns

- Name

LASTCHANGED

23.5.6 Content

Name	Data Type	Mandatory	Comment
PREDISPATCHSEQNO	VARCHAR2(20)	X	Predispatch run identifier
LINKID	VARCHAR2(10)	X	Identifier for each of the two MNSP Interconnector Links. Each link pertains to the direction from and to.
PERIODID	VARCHAR2(20)	X	Trading Interval number
PARTICIPANTID	VARCHAR2(10)		Participant Identifier
SETTLEMENTDATE	DATE		Market Date from which bid is active
OFFERDATE	DATE		Offer date for bid
VERSIONNO	NUMBER(3,0)		Version No. for given offer date and settlement date used
DATETIME	DATE		Period expressed as Date/Time
LASTCHANGED	DATE		Record creation timestamp

23.6 Table: PREDISPATCBLOCKEDCONSTRAINT

23.6.1 PREDISPATCBLOCKEDCONSTRAINT

Name	PREDISPATCBLOCKEDCONSTRAINT
Comment	PREDISPATCH Blocked Constraints lists any constraints that were blocked in a Predispatch run. If no constraints are blocked, there will be no rows for that predispatch run.

23.6.2 Notes

Name	Comment	Value
Visibility	Data in this table is:	Public

23.6.3 Primary Key Columns

Name
CONSTRAINTID
PREDISPATCHSEQNO

23.6.4 Content

Name	Data Type	Mandatory	Comment
PREDISPATCHSEQNO	VARCHAR2(20))	X	Unique identifier of predispatch run in the form YYYYMMDDPP with 01 at 04:30
CONSTRAINTID	VARCHAR2(20))	X	Generic Constraint identifier (synonymous with GenConID)

23.7 Table: PREDISPATHCASESOLUTION

23.7.1 PREDISPATHCASESOLUTION

Name	PREDISPATHCASESOLUTION
Comment	PREDISPATHCASESOLUTION provides information relating to the complete predispatch run. The fields provide an overview of the dispatch run results allowing immediate identification of conditions such as energy or FCAS deficiencies.

23.7.2 Description

PREDISPATHCASESOLUTION data is public, so is available to all participants.

Source

PREDISPATHCASESOLUTION updates every half-hour.

Volume

Approximately 48 records per day.

23.7.3 Notes

Name	Comment	Value
Visibility	Data in this table is:	Public

23.7.4 Primary Key Columns

- Name
- PREDISPATHCASESOLUTION
- RUNNO

23.7.5 Index Columns

- Name
- LASTCHANGED

23.7.6 Content

Name	Data Type	Mandatory	Comment
PREDISPATCHSEQNO	VARCHAR2(20)	X	Unique identifier of predispatch run in the form YYYYMMDDPP with 01 at 04:30
RUNNO	NUMBER(3,0)	X	Predispatch run no, normally 1.
SOLUTIONSTATUS	NUMBER(2,0)		If non-zero indicated one of the following conditions: 1 = Supply Scarcity, Excess generation or constraint violations, -X = Model failure
SPDVERSION	VARCHAR2(20)		Current version of SPD
NONPHYSICALLOSSES	NUMBER(1,0)		Non-Physical Losses algorithm invoked during this run
TOTALOBJECTIVE	NUMBER(27,10)		The Objective function from the LP
TOTALAREAGENVIO LATION	NUMBER(15,5)		Total Region Demand violations
TOTALINTERCONNECTORV IOLATION	NUMBER(15,5)		Total interconnector violations
TOTALGENERICVIOLATION	NUMBER(15,5)		Total generic constraint violations
TOTALRAMPRATEVIOLATI ON	NUMBER(15,5)		Total ramp rate violations
TOTALUNITMWCAPACITYV IOLATION	NUMBER(15,5)		Total unit capacity violations
TOTAL5MINVIOLATION	NUMBER(15,5)		Total of 5 minute ancillary service

			region violations
TOTALREGVIOLATION	NUMBER(15,5)		Total of Regulation ancillary service region violations
TOTAL6SECVIOLATION	NUMBER(15,5)		Total of 6 second ancillary service region violations
TOTAL60SECVIOLATION	NUMBER(15,5)		Total of 60 second ancillary service region violations
TOTALASPROFILEVIOLATION	NUMBER(15,5)		Total of ancillary service trader profile violations
TOTALENERGYCONSTRVIOLATION	NUMBER(15,5)		Total of Energy Constrained unit offer violations.
TOTALENERGYOFFERVIOLATION	NUMBER(15,5)		Total of unit summated offer band violations
LASTCHANGED	DATE		Last date and time record changed
INTERVENTION	NUMBER(2,0)		Flag to indicate if this Pre-Dispatch case includes an intervention pricing run: 0 = case does not include an intervention pricing run, 1 = case does include an intervention pricing run. This field has a default value of 0 and is not nullable

23.8 Table: PREDISPATCHCONSTRAINT

23.8.1 PREDISPATCHCONSTRAINT

Name	PREDISPATCHCONSTRAINT
Comment	<p>PREDISPATCHCONSTRAINT sets out constraints that are binding in each predispatch run and interconnector constraints (whether binding or not). Only binding and interconnector constraints are reported. Binding contracts have marginal value greater than \$0. Interconnector constraints are listed so RHS values can be reported for ST PASA.</p> <p>Constraint solutions only report fixed loading /MR constraints on the next day.</p>

23.8.2 Description

PREDISPATCHCONSTRAINT data is confidential on the day of creation, and public to all participants after the end of the market day.

Source

PREDISPATCHCONSTRAINT updates with every thirty-minute predispatch run.

Note

The PERIODID columns in tables PREDISPATCHCONSTRAINT and PREDISPATCH_FCAS_REQ have no consistent relationship with the other PERIODID values in the other tables in the PRE-DISPATCH package (such as PREDISPATCHPRICE). AEMO and many Participants appreciate the data model is inconsistent, but the cost of changing existing systems has been judged as being unjustifiable. An additional field DATETIME was added to allow joins between these data sets.

23.8.3 Notes

Name	Comment	Value
Visibility	Data in this table is:	Private; Public Next-Day

23.8.4 Primary Key Columns

Name

CONSTRAINTID

DATETIME

23.8.5 Index Columns

Name

PREDISPATCHSEQNO

23.8.6 Index Columns

Name

LASTCHANGED

23.8.7 Content

Name	Data Type	Mandatory	Comment
PREDISPATCHSEQNO	VARCHAR2(20)		Unique identifier of predispatch run in the form YYYYMMDDPP with 01 at 04:30
RUNNO	NUMBER(3,0)		SPD Predispatch run no, typically 1. It increments if the case is re-run.
CONSTRAINTID	VARCHAR2(20)	X	Generic constraint identifier
PERIODID	VARCHAR2(20)		Unique period identifier, in the format yyymmddpp. The period (pp) is 01 to 48, with 01 corresponding to the half-hour ending at 04:30am.
INTERVENTION	NUMBER(2,0)		Flag to indicate if this result set was sourced from the pricing run

			(INTERVENTION=0) or the physical run (INTERVENTION=1). In the event that there is not intervention in the market, both pricing and physical runs correspond to INTERVENTION=0
RHS	NUMBER(15,5)		RHS value used.
MARGINALVALUE	NUMBER(15,5)		Marginal value of violated constraint
VIOLATIONDEGREE	NUMBER(15,5)		Degree of constraint violation
LASTCHANGED	DATE		Last date and time record changed
DATETIME	DATE	X	Period date and time
DUID	VARCHAR2(20)		DUID to which the Constraint is confidential. Null denotes non-confidential
GENCONID_EFFECTIVEDATE	DATE		Effective date of the Generic Constraint (ConstraintID). This field is used to track the version of this generic constraint applied in this dispatch interval
GENCONID_VERSIONNO	NUMBER(22,0)		Version number of the Generic Constraint (ConstraintID). This field is used to track the version of this generic constraint applied in this dispatch interval
LHS	number(15,5)		Aggregation of the constraints LHS term solution values

23.9 Table: PREDISPATCHINTERCONNECTORRES

23.9.1 PREDISPATCHINTERCONNECTORRES

Name	PREDISPATCHINTERCONNECTORRES
Comment	<p>PREDISPATCHINTERCONNECTORRES records Interconnector flows and losses for the periods calculated in each predispach run. Only binding and interconnector constraints are reported.</p> <p>Some fields are for the Frequency Controlled Ancillary Services export and import limits and extra reporting of the generic constraint setting the energy import and export limits.</p>

23.9.2 Description

Source

PREDISPATCHINTERCONNECTORRES updates with every thirty-minute predispach run.

Note

MW losses can be negative depending on the flow.

The definition of direction of flow for an interconnector is that positive flow starts from the FROMREGION in INTERCONNECTOR.

23.9.3 Notes

Name	Comment	Value
Visibility	Data in this table is:	Public

23.9.4 Primary Key Columns

- Name
- DATETIME
- INTERCONNECTORID

23.9.5 Index Columns

Name

PREDISPATCHSEQNO

23.9.6 Index Columns

Name

LASTCHANGED

23.9.7 Content

Name	Data Type	Mandatory	Comment
PREDISPATCHSEQNO	VARCHAR2(20)		Unique identifier of predispach run in the form YYYYMMDDPP with 01 at 04:30
RUNNO	NUMBER(3,0)		SPD Predispach run no, typically 1. It increments if the case is re-run.
INTERCONNECTORID	VARCHAR2(10)	X	Interconnector identifier
PERIODID	VARCHAR2(20)		PERIODID is just a period count, starting from 1 for each predispach run. Use DATETIME to determine half hour period.
INTERVENTION	NUMBER(2,0)		Flag to indicate if this result set was sourced from the pricing run (INTERVENTION=0) or the physical run (INTERVENTION=1). In the event that there is not intervention in the market, both pricing and physical runs correspond to INTERVENTION=0

METEREDMWFLOW	NUMBER(15,5)		Metered MW Flow from EMS. For periods subsequent to the first period of a Pre-Dispatch run, this value represents the cleared target for the previous period of that Pre-Dispatch run.
MWFLOW	NUMBER(15,5)		Calculated MW Flow
MWLOSSES	NUMBER(15,5)		Calculated MW Losses
MARGINALVALUE	NUMBER(15,5)		\$ Marginal value of interconnector constraint from SPD
VIOLATIONDEGREE	NUMBER(15,5)		Degree of violation of interconnector constraint in MW
LASTCHANGED	DATE		Last changed.
DATETIME	DATE	X	Period date and time
EXPORTLIMIT	NUMBER(15,5)		Calculated export limit.
IMPORTLIMIT	NUMBER(15,5)		Calculated import limit.
MARGINALLOSS	NUMBER(15,5)		Marginal loss factor. Use this to adjust bids between reports.
EXPORTGENCONID	VARCHAR2(20)		Generic Constraint setting the export limit
IMPORTGENCONID	VARCHAR2(20)		Generic Constraint setting the import limit
FCASEXPORTLIMIT	NUMBER(15,5)		Calculated export limit applying to energy + FCAS.
FCASIMPORTLIMIT	NUMBER(15,5)		Calculated import limit applying to energy + FCAS.
LOCAL_PRICE_ADJUSTMENT_EXPORT	NUMBER(10,2)		Aggregate Constraint contribution cost of this Interconnector: Sum(MarginalValue x Factor) for all

			relevant Constraints, for Export (Factor >= 0)
LOCALLY_CONSTRAINED_EXPORT	NUMBER(1,0)		Key for Local_Price_Adjustment_Export: 2 = at least one Outage Constraint; 1 = at least 1 System Normal Constraint (and no Outage Constraint); 0 = No System Normal or Outage Constraints
LOCAL_PRICE_ADJUSTMENT_IMPORT	NUMBER(10,2)		Aggregate Constraint contribution cost of this Interconnector: Sum(MarginalValue x Factor) for all relevant Constraints, for Import (Factor >= 0)
LOCALLY_CONSTRAINED_IMPORT	NUMBER(1,0)		Key for Local_Price_Adjustment_Import: 2 = at least one Outage Constraint; 1 = at least 1 System Normal Constraint (and no Outage Constraint); 0 = No System Normal or Outage Constraints

23.10 Table: PREDISPATCHINTERSENSITIVITIES

23.10.1 PREDISPATCHINTERSENSITIVITIES

Name	PREDISPATCHINTERSENSITIVITIES
Comment	PREDISPATCHINTERSENSITIVITIES sets out the sensitivity flows for each interconnector by period.

23.10.2 Primary Key Columns

Name
DATETIME
INTERCONNECTORID

23.10.3 Index Columns

Name
LASTCHANGED

23.10.4 Content

Name	Data Type	Mandatory	Comment
PREDISPATCHSEQNO	VARCHAR2(20)		Unique identifier of predispach run in the form YYYYMMDDPP with 01 at 04:30
RUNNO	NUMBER(3,0)		LP Solver Predispach run no, typically 1. It increments if the case is re-run.
INTERCONNECTORID	VARCHAR2(10)	X	Unique interconnector identifier

PERIODID	VARCHAR2(20)		PERIODID is just a period count, starting from 1 for each predispach run. Use DATETIME to determine half hour period.
INTERVENTION	NUMBER(2,0)		Flag to indicate if this result set was sourced from the pricing run (INTERVENTION=0) or the physical run (INTERVENTION=1). In the event that there is not intervention in the market, both pricing and physical runs correspond to INTERVENTION=0
DATETIME	DATE	X	Period date and time
INTERVENTION_ACTIVE	NUMBER(1,0)		Flag to indicate if this period has an active intervention constraint: 0= No, 1= Yes
MWFLOW1	NUMBER(15,5)		MW flow for given Interconnector for scenario 1
MWFLOW2	NUMBER(15,5)		MW flow for given Interconnector for scenario 2
MWFLOW3	NUMBER(15,5)		MW flow for given Interconnector for scenario 3
MWFLOW4	NUMBER(15,5)		MW flow for given Interconnector for scenario 4
MWFLOW5	NUMBER(15,5)		MW flow for given Interconnector for scenario 5
MWFLOW6	NUMBER(15,5)		MW flow for given Interconnector for scenario 6
MWFLOW7	NUMBER(15,5)		MW flow for given Interconnector for scenario 7
MWFLOW8	NUMBER(15,5)		MW flow for given Interconnector

			for scenario 8
MWFLOW9	NUMBER(15,5)		MW flow for given Interconnector for scenario 9
MWFLOW10	NUMBER(15,5)		MW flow for given Interconnector for scenario 10
MWFLOW11	NUMBER(15,5)		MW flow for given Interconnector for scenario 11
MWFLOW12	NUMBER(15,5)		MW flow for given Interconnector for scenario 12
MWFLOW13	NUMBER(15,5)		MW flow for given Interconnector for scenario 13
MWFLOW14	NUMBER(15,5)		MW flow for given Interconnector for scenario 14
MWFLOW15	NUMBER(15,5)		MW flow for given Interconnector for scenario 15
MWFLOW16	NUMBER(15,5)		MW flow for given Interconnector for scenario 16
MWFLOW17	NUMBER(15,5)		MW flow for given Interconnector for scenario 17
MWFLOW18	NUMBER(15,5)		MW flow for given Interconnector for scenario 18
MWFLOW19	NUMBER(15,5)		MW flow for given Interconnector for scenario 19
MWFLOW20	NUMBER(15,5)		MW flow for given Interconnector for scenario 20
MWFLOW21	NUMBER(15,5)		MW flow for given Interconnector for scenario 21
MWFLOW22	NUMBER(15,5)		MW flow for given Interconnector for scenario 22

MWFLOW23	NUMBER(15,5)		MW flow for given Interconnector for scenario 23
MWFLOW24	NUMBER(15,5)		MW flow for given Interconnector for scenario 24
MWFLOW25	NUMBER(15,5)		MW flow for given Interconnector for scenario 25
MWFLOW26	NUMBER(15,5)		MW flow for given Interconnector for scenario 26
MWFLOW27	NUMBER(15,5)		MW flow for given Interconnector for scenario 27
MWFLOW28	NUMBER(15,5)		MW flow for given Interconnector for scenario 28
MWFLOW29	NUMBER(15,5)		MW flow for given Interconnector for scenario 29
MWFLOW30	NUMBER(15,5)		MW flow for given Interconnector for scenario 30
MWFLOW31	NUMBER(15,5)		MW flow for given Interconnector for scenario 31
MWFLOW32	NUMBER(15,5)		MW flow for given Interconnector for scenario 32
MWFLOW33	NUMBER(15,5)		MW flow for given Interconnector for scenario 33
MWFLOW34	NUMBER(15,5)		MW flow for given Interconnector for scenario 34
MWFLOW35	NUMBER(15,5)		MW flow for given Interconnector for scenario 35
MWFLOW36	NUMBER(15,5)		MW flow for given Interconnector for scenario 36

MWFLOW37	NUMBER(15,5)		MW flow for given Interconnector for scenario 37
MWFLOW38	NUMBER(15,5)		MW flow for given Interconnector for scenario 38
MWFLOW39	NUMBER(15,5)		MW flow for given Interconnector for scenario 39
MWFLOW40	NUMBER(15,5)		MW flow for given Interconnector for scenario 40
MWFLOW41	NUMBER(15,5)		MW flow for given Interconnector for scenario 41
MWFLOW42	NUMBER(15,5)		MW flow for given Interconnector for scenario 42
MWFLOW43	NUMBER(15,5)		MW flow for given Interconnector for scenario 43
LASTCHANGED	DATE		Last date and time record changed

23.11 Table: PREDISPATCHLOAD

23.11.1 PREDISPATCHLOAD

Name PREDISPATCHLOAD

Comment PREDISPATCHLOAD shows pre-dispatch targets for each dispatchable unit, including additional fields to handle the Ancillary Services functionality. No record is written where a unit is not dispatched. PREDISPATCHLOAD shows all the results for each period.

23.11.2 Description

Source

Own (confidential) data updates every thirty minutes, with whole market data for the day before available as part of next day market data.

Note

** A flag exists for each ancillary service type such that a unit trapped or stranded in one or more service type can be immediately identified. The flag is defined using the low 3 bits as follows:

Flag Name	Bit	Description
Enabled	0	The unit is enabled to provide this ancillary service type.
Trapped	1	The unit is enabled to provide this ancillary service type, however the profile for this service type is causing the unit to be trapped in the energy market.
Stranded	2	The unit is bid available to provide this ancillary service type, however, the unit is operating in the energy market outside of the profile for this service type and is stranded from providing this service.

Interpretation of the bit-flags as a number gives the following possibilities (i.e. other combinations are not possible):

Numeric Value	Bit (2,1,0)	Meaning
0	000	Not stranded, not trapped, not enabled (i.e. is unavailable).
1	001	Not stranded, not trapped, is enabled (i.e. available).
3	011	Not stranded, is trapped, is enabled (i.e. trapped).
4	100	Is stranded, not trapped, not enabled (i.e. stranded).

For example, testing for availability can be done by checking for odd (=available) or even (=unavailable) number (e.g. $\text{mod}(\text{flag}, 2)$ results in 0 for unavailable and 1 for available).

*** "Actual FCAS availability" is determined in a post-processing step based on the energy target (TotalCleared) and bid FCAS trapezium for that interval. However, if the unit is outside the bid FCAS trapezium at the start of the interval (InitialMW), the "Actual FCAS availability" is set to zero. For regulation services, the trapezium is the most restrictive of the bid/SCADA trapezium values.

23.11.3 Notes

Name	Comment	Value
Visibility	Data in this table is:	Private; Public Next-Day

23.11.4 Primary Key Columns

Name
 DATETIME
 DUID

23.11.5 Index Columns

Name
 LASTCHANGED

23.11.6 Index Columns

Name
 DUID
 LASTCHANGED

23.11.7 Index Columns

Name
 PREDISPATCHSEQNO

23.11.8 Content

Name	Data Type	Manda	Comment
------	-----------	-------	---------

		tory	
PREDISPATCHSEQNO	VARCHAR2(20))		Unique identifier of predispatch run in the form YYYYMMDDPP with 01 at 04:30
RUNNO	NUMBER(3,0)		SPD Predispatch run no, typically 1. It increments if the case is re-run.
DUID	VARCHAR2(10))	X	Dispatchable unit identifier for fast start
TRADETYPE	NUMBER(2,0)		Not used
PERIODID	VARCHAR2(20))		PERIODID is just a period count, starting from 1 for each predispatch run. Use DATETIME to determine half hour period.
INTERVENTION	NUMBER(2,0)		Flag to indicate if this result set was sourced from the pricing run (INTERVENTION=0) or the physical run (INTERVENTION=1). In the event that there is not intervention in the market, both pricing and physical runs correspond to INTERVENTION=0
CONNECTIONPOINTID	VARCHAR2(12))		Connection point identifier
AGCSTATUS	NUMBER(2,0)		AGC Status from EMS
DISPATCHMODE	NUMBER(2,0)		Dispatch mode of unit for fast start (1-4)
INITIALMW	NUMBER(15,5)		Initial MW at start of first period. For periods subsequent to the first period of a Pre-Dispatch run, this value represents the cleared target for the previous period of that Pre-Dispatch run.

TOTALCleared	NUMBER(15,5)		Target MW at end of period
LOWER5MIN	NUMBER(15,5)		Lower 5 min MW target in period
LOWER60SEC	NUMBER(15,5)		Lower 60 sec MW target in period
LOWER6SEC	NUMBER(15,5)		Lower 6 sec MW target in period
RAISE5MIN	NUMBER(15,5)		Raise 5 min MW target in period
RAISE60SEC	NUMBER(15,5)		Raise 60 sec MW target in period
RAISE6SEC	NUMBER(15,5)		Raise 6 sec MW target in period
RAMPDOWNRATE	NUMBER(15,5)		Ramp down rate in period in MW/minute
RAMPUPRATE	NUMBER(15,5)		Ramp up rate in period in MW/minute
DOWNEPF	NUMBER(15,5)		Not used in Pre-Dispatch
UPEPF	NUMBER(15,5)		Not used in Pre-Dispatch
MARGINAL5MINVALUE	NUMBER(15,5)		Marginal \$ value for 5 min from LP Solver
MARGINAL60SECVALUE	NUMBER(15,5)		Marginal \$ value for 60 seconds from LP Solver
MARGINAL6SECVALUE	NUMBER(15,5)		Marginal \$ value for 6 seconds from LP Solver
MARGINALVALUE	NUMBER(15,5)		Marginal \$ value for energy from LP Solver
VIOLATION5MINDEGREE	NUMBER(15,5)		Violation MW 5 min
VIOLATION60SECDEGREE	NUMBER(15,5)		Violation MW 60 seconds
VIOLATION6SECDEGREE	NUMBER(15,5)		Violation MW 6 seconds
VIOLATIONDEGREE	NUMBER(15,5)		Violation MW energy

LASTCHANGED	DATE		Last date and time record changed
DATETIME	DATE	X	Period date and time
LOWERREG	NUMBER(15,5)		Lower Regulation reserve target
RAISEREG	NUMBER(15,5)		Raise Regulation reserve target
AVAILABILITY	NUMBER(15,5)		Bid energy availability
RAISE6SECFLAGS	NUMBER(3,0)		Raise 6sec status flag
RAISE60SECFLAGS	NUMBER(3,0)		Raise 60sec status flag
RAISE5MINFLAGS	NUMBER(3,0)		Raise 5min status flag
RAISEREGFLAGS	NUMBER(3,0)		Raise reg status flag
LOWER6SECFLAGS	NUMBER(3,0)		Lower 6sec status flag
LOWER60SECFLAGS	NUMBER(3,0)		Lower 60sec status flag
LOWER5MINFLAGS	NUMBER(3,0)		Lower 5min status flag
LOWERREGFLAGS	NUMBER(3,0)		Lower Reg status flag
RAISE6SECACTUALAVAILABILITY	NUMBER(16,6)		trapezium adjusted raise 6sec availability
RAISE60SECACTUALAVAILABILITY	NUMBER(16,6)		trapezium adjusted raise 60sec availability
RAISE5MINACTUALAVAILABILITY	NUMBER(16,6)		trapezium adjusted raise 5min availability
RAISEREGACTUALAVAILABILITY	NUMBER(16,6)		trapezium adjusted raise reg availability
LOWER6SECACTUALAVAILABILITY	NUMBER(16,6)		trapezium adjusted lower 6sec availability
LOWER60SECACTUALAVAILABILITY	NUMBER(16,6)		trapezium adjusted lower 60sec availability

LOWER5MINACTUALAVAILABILITY	NUMBER(16,6)		trapezium adjusted lower 5min availability
LOWERREGACTUALAVAILABILITY	NUMBER(16,6)		trapezium adjusted lower reg availability
SEMIDISPATCHCAP	NUMBER(3,0)		Boolean representation flagging if the Target is Capped

23.12 Table: PREDISPATCHOFFERTRK

23.12.1 PREDISPATCHOFFERTRK

Name	PREDISPATCHOFFERTRK
Comment	PREDISPATCHOFFERTRK is for the ancillary service bid tracking of predispach processing. PREDISPATCHOFFERTRK identifies which bids from BIDDAYOFFER and BIDPEROFFER were applied for a given unit and ancillary service for each predispach run.

23.12.2 Description

Source

PREDISPATCHOFFERTRK updates every 30 minutes. The data is confidential to each participant until the next trading day.

Volume

Approximately 45,000 records per day.

23.12.3 Notes

Name	Comment	Value
Visibility	Data in this table is:	Private; Public Next-Day

23.12.4 Primary Key Columns

- Name
- BIDTYPE
- DUID
- PERIODID
- PREDISPATCSEQNO

23.12.5 Index Columns

Name

LASTCHANGED

23.12.6 Content

Name	Data Type	Mandatory	Comment
PREDISPATCHSEQNO	VARCHAR2(20)	X	Unique identifier of predispatch run in the form YYYYMMDDPP with 01 at 04:30
DUID	VARCHAR2(10)	X	Dispatchable Unit identifier
BIDTYPE	VARCHAR2(20)	X	Bid type Identifier - the ancillary service to which the bid applies
PERIODID	VARCHAR2(20)	X	PERIODID is just a period count, starting from 1 for each predispatch run. Use DATETIME to determine half hour period.
BIDSETTLEMENTDATE	DATE		Settlement date of bid applied
BIDOFFERDATE	DATE		Offer date of bid applied
DATETIME	DATE		Period date and time
LASTCHANGED	DATE		Last date and time record changed

23.13 Table: PREDISPATCHPRICE

23.13.1 PREDISPATCHPRICE

Name	PREDISPATCHPRICE
Comment	PREDISPATCHPRICE records predispatch prices for each region by period for each predispatch run, including fields to handle the Ancillary Services functionality.

23.13.2 Description

PREDISPATCHPRICE data is public, so is available to all participants.

Source

PREDISPATCHPRICE updates with every thirty-minute predispatch run.

23.13.3 Notes

Name	Comment	Value
Visibility	Data in this table is:	Public

23.13.4 Primary Key Columns

- Name
- DATETIME
- REGIONID

23.13.5 Index Columns

- Name
- LASTCHANGED

23.13.6 Index Columns

Name

PREDISPATCHSEQNO

23.13.7 Content

Name	Data Type	Mandatory	Comment
PREDISPATCHSEQNO	VARCHAR2(20)		Unique identifier of predispach run in the form YYYYMMDDPP with 01 at 04:30
RUNNO	NUMBER(3,0)		LP Solver Predispach run no, typically 1. It increments if the case is re-run.
REGIONID	VARCHAR2(10)	X	Unique region identifier
PERIODID	VARCHAR2(20)		PERIODID is just a period count, starting from 1 for each predispach run. Use DATETIME to determine half hour period.
INTERVENTION	NUMBER(2,0)		Flag to indicate if this result set was sourced from the pricing run (INTERVENTION=0) or the physical run (INTERVENTION=1). In the event that there is not intervention in the market, both pricing and physical runs correspond to INTERVENTION=0
RRP	NUMBER(15,5)		Regional Reference Price
EEP	NUMBER(15,5)		Excess energy price
RRP1	NUMBER(15,5)		Not used

EEP1	NUMBER(15,5)		Not used
RRP2	NUMBER(15,5)		Not used
EEP2	NUMBER(15,5)		Not used
RRP3	NUMBER(15,5)		Not used
EEP3	NUMBER(15,5)		Not used
RRP4	NUMBER(15,5)		Not used
EEP4	NUMBER(15,5)		Not used
RRP5	NUMBER(15,5)		Not used
EEP5	NUMBER(15,5)		Not used
RRP6	NUMBER(15,5)		Not used
EEP6	NUMBER(15,5)		Not used
RRP7	NUMBER(15,5)		Not used
EEP7	NUMBER(15,5)		Not used
RRP8	NUMBER(15,5)		Not used
EEP8	NUMBER(15,5)		Not used
LASTCHANGED	DATE		Last date and time record changed
DATETIME	DATE	X	Period date and time
RAISE6SECRRP	NUMBER(15,5)		Regional reference price for this dispatch period
RAISE60SECRRP	NUMBER(15,5)		Regional reference price for this dispatch period
RAISE5MINRRP	NUMBER(15,5)		Regional reference price for this dispatch period
RAISEREGRRP	NUMBER(15,5)		Regional reference price for this

			dispatch period
LOWER6SECRRP	NUMBER(15,5)		Regional reference price for this dispatch period
LOWER60SECRRP	NUMBER(15,5)		Regional reference price for this dispatch period
LOWER5MINRRP	NUMBER(15,5)		Regional reference price for this dispatch period
LOWERREGRRP	NUMBER(15,5)		Regional reference price for this dispatch period

23.14 Table: PREDISPATCHPRICESENSITIVITIES

23.14.1 PREDISPATCHPRICESENSITIVITIES

Name	PREDISPATCHPRICESENSITIVITIES
Comment	PREDISPATCHPRICESENSITIVITIES sets out the sensitivity prices for each region by period.

23.14.2 Description

Source

The plan is to provide this data every half-hour.

23.14.3 Notes

Name	Comment	Value
Visibility	Data in this table is:	Public

23.14.4 Primary Key Columns

Name
DATETIME
REGIONID

23.14.5 Index Columns

Name
PREDISPATCHSEQNO

23.14.6 Index Columns

Name

LASTCHANGED

23.14.7 Content

Name	Data Type	Mandatory	Comment
PREDISPATCHSEQNO	VARCHAR2(20)		Unique identifier of predispatch run in the form YYYYMMDDPP with 01 at 04:30
RUNNO	NUMBER(3,0)		LP Solver Predispatch run no, typically 1. It increments if the case is re-run.
REGIONID	VARCHAR2(10)	X	Unique region identifier
PERIODID	VARCHAR2(20)		PERIODID is just a period count, starting from 1 for each predispatch run. Use DATETIME to determine half hour period.
INTERVENTION	NUMBER(2,0)		Flag to indicate if this result set was sourced from the pricing run (INTERVENTION=0) or the physical run (INTERVENTION=1). In the event that there is not intervention in the market, both pricing and physical runs correspond to INTERVENTION=0
RRPEEP1	NUMBER(15,5)		Regional Energy Price for scenario 1
RRPEEP2	NUMBER(15,5)		Regional Energy Price for scenario 2
RRPEEP3	NUMBER(15,5)		Regional Energy Price for scenario 3

RRPEEP4	NUMBER(15,5)		Regional Energy Price for scenario 4
RRPEEP5	NUMBER(15,5)		Regional Energy Price for scenario 5
RRPEEP6	NUMBER(15,5)		Regional Energy Price for scenario 6
RRPEEP7	NUMBER(15,5)		Regional Energy Price for scenario 7
RRPEEP8	NUMBER(15,5)		Regional Energy Price for scenario 8
RRPEEP9	NUMBER(15,5)		Regional Energy Price for scenario 9
RRPEEP10	NUMBER(15,5)		Regional Energy Price for scenario 10
RRPEEP11	NUMBER(15,5)		Regional Energy Price for scenario 11
RRPEEP12	NUMBER(15,5)		Regional Energy Price for scenario 12
RRPEEP13	NUMBER(15,5)		Regional Energy Price for scenario 13
RRPEEP14	NUMBER(15,5)		Regional Energy Price for scenario 14
RRPEEP15	NUMBER(15,5)		Regional Energy Price for scenario 15
RRPEEP16	NUMBER(15,5)		Regional Energy Price for scenario 16
RRPEEP17	NUMBER(15,5)		Regional Energy Price for scenario 17

RRPEEP18	NUMBER(15,5)		Regional Energy Price for scenario 18
RRPEEP19	NUMBER(15,5)		Regional Energy Price for scenario 19
RRPEEP20	NUMBER(15,5)		Regional Energy Price for scenario 20
RRPEEP21	NUMBER(15,5)		Regional Energy Price for scenario 21
RRPEEP22	NUMBER(15,5)		Regional Energy Price for scenario 22
RRPEEP23	NUMBER(15,5)		Regional Energy Price for scenario 23
RRPEEP24	NUMBER(15,5)		Regional Energy Price for scenario 24
RRPEEP25	NUMBER(15,5)		Regional Energy Price for scenario 25
RRPEEP26	NUMBER(15,5)		Regional Energy Price for scenario 26
RRPEEP27	NUMBER(15,5)		Regional Energy Price for scenario 27
RRPEEP28	NUMBER(15,5)		Regional Energy Price for scenario 28
LASTCHANGED	DATE		Last date and time record changed
DATETIME	DATE	X	Period date and time
RRPEEP29	NUMBER(15,5)		Regional Energy Price for scenario 29
RRPEEP30	NUMBER(15,5)		Regional Energy Price for scenario 30

RRPEEP31	NUMBER(15,5)		Regional Energy Price for scenario 31
RRPEEP32	NUMBER(15,5)		Regional Energy Price for scenario 32
RRPEEP33	NUMBER(15,5)		Regional Energy Price for scenario 33
RRPEEP34	NUMBER(15,5)		Regional Energy Price for scenario 34
RRPEEP35	NUMBER(15,5)		Regional Energy Price for scenario 35
INTERVENTION_ACTIVE	NUMBER(1,0)		Flag to indicate if this period has an active intervention constraint: 0= No, 1= Yes
RRPEEP36	NUMBER(15,5)		Regional Energy Price for scenario 36
RRPEEP37	NUMBER(15,5)		Regional Energy Price for scenario 37
RRPEEP38	NUMBER(15,5)		Regional Energy Price for scenario 38
RRPEEP39	NUMBER(15,5)		Regional Energy Price for scenario 39
RRPEEP40	NUMBER(15,5)		Regional Energy Price for scenario 40
RRPEEP41	NUMBER(15,5)		Regional Energy Price for scenario 41
RRPEEP42	NUMBER(15,5)		Regional Energy Price for scenario 42
RRPEEP43	NUMBER(15,5)		Regional Energy Price for scenario 43

23.15 Table: PREDISPATCHREGIONSUM

23.15.1 PREDISPATCHREGIONSUM

Name	PREDISPATCHREGIONSUM
Comment	PREDISPATCHREGIONSUM sets out the overall regional Pre-Dispatch results for base case details (excluding price).

23.15.2 Description

PREDISPATCHREGIONSUM includes the forecast demand (total demand) and Frequency Control Ancillary Services (FCAS) requirements (specifically, for the Raise Regulation and Lower Regulation Ancillary Services plus improvements to demand calculations). PREDISPATCHREGIONSUM updates each half-hour with the latest Pre-Dispatch details for the remaining period.

Regional demand can be calculated as total demand plus dispatchable load (i.e. Regional demand = Total Demand + Dispatchable Load)

Source

PREDISPATCHREGIONSUM updates every thirty minutes.

Note

*** "Actual FCAS availability" is determined in a post-processing step based on the energy target (TotalCleared) and bid FCAS trapezium for that interval. However, if the unit is outside the bid FCAS trapezium at the start of the interval (InitialMW), the "Actual FCAS availability" is set to zero. For regulation services, the trapezium is the most restrictive of the bid/SCADA trapezium values.

From 16 February 2006, the old reserve values are no longer populated (i.e. are null), being LORSurplus and LRCSurplus. For more details on the changes to Reporting of Reserve Condition Data, refer to AEMO Communication 2042. For the best available indicator of reserve condition in each of the regions of the NEM for each trading interval, refer to the latest run of the Pre-Dispatch PASA (see table PDPASA_REGIONSOLUTION).

23.15.3 Notes

Name	Comment	Value
Visibility	Data in this table is:	Public

23.15.4 Primary Key Columns

Name

DATETIME

REGIONID

23.15.5 Index Columns

Name

LASTCHANGED

23.15.6 Index Columns

Name

PREDISPATCHSEQNO

23.15.7 Content

Name	Data Type	Mandatory	Comment
PREDISPATCHSEQNO	VARCHAR2(20)		Unique identifier of predispatch run in the form YYYYMMDDPP with 01 at 04:30
RUNNO	NUMBER(3,0)		LP Solver Pre-Dispatch run no, typically 1. It increments if the case is re-run.
REGIONID	VARCHAR2(10)	X	Unique region identifier
PERIODID	VARCHAR2(20)		PERIODID is just a period count, starting from 1 for each Pre-Dispatch run. Use DATETIME to determine half hour period.
INTERVENTION	NUMBER(2,0)		Flag to indicate if this result set was sourced from the pricing run

			(INTERVENTION=0) or the physical run (INTERVENTION=1). In the event that there is not intervention in the market, both pricing and physical runs correspond to INTERVENTION=0
TOTALDEMAND	NUMBER(15,5)		Total demand in MW for period (less normally on loads)
AVAILABLEGENERATION	NUMBER(15,5)		Aggregate generation bid available in region
AVAILABLELOAD	NUMBER(15,5)		Aggregate load bid available in region
DEMANDFORECAST	NUMBER(15,5)		Delta MW value only
DISPATCHABLEGENERATION	NUMBER(15,5)		Generation dispatched in period
DISPATCHABLELOAD	NUMBER(15,5)		Load dispatched in period
NETINTERCHANGE	NUMBER(15,5)		Net interconnector flow from the regional reference node
EXCESSGENERATION	NUMBER(15,5)		Excess generation in period / Deficit generation if VOLL
LOWER5MINDISPATCH	NUMBER(15,5)		Not used since Dec 2003. Lower 5 min MW dispatch
LOWER5MINIMPORT	NUMBER(15,5)		Not used since Dec 2003. Lower 5 min MW imported
LOWER5MINLOCALDISPATCH	NUMBER(15,5)		Lower 5 min local dispatch
LOWER5MINLOCALPRICE	NUMBER(15,5)		Not used since Dec 2003. Local price of lower 5 min
LOWER5MINLOCALREQ	NUMBER(15,5)		Not used since Dec 2003. Lower 5

			min local requirement
LOWER5MINPRICE	NUMBER(15,5)		Not used since Dec 2003. Regional price of lower 5 min
LOWER5MINREQ	NUMBER(15,5)		Not used since Dec 2003. Lower 5 min total requirement
LOWER5MINSUPPLYPRICE	NUMBER(15,5)		Not used since Dec 2003. Supply price of lower 5 min
LOWER60SECDISPATCH	NUMBER(15,5)		Not used since Dec 2003. Lower 60 sec MW dispatch
LOWER60SECIMPORT	NUMBER(15,5)		Not used since Dec 2003. Lower 60 sec MW imported
LOWER60SECLOCALDISPATCH	NUMBER(15,5)		Lower 60 sec local dispatch
LOWER60SECLOCALPRICE	NUMBER(15,5)		Not used since Dec 2003. Local price of lower 60 sec
LOWER60SECLOCALREQ	NUMBER(15,5)		Not used since Dec 2003. Lower 60 sec local requirement
LOWER60SECPRICE	NUMBER(15,5)		Not used since Dec 2003. Regional price of lower 60 sec
LOWER60SECREQ	NUMBER(15,5)		Not used since Dec 2003. Lower 60 sec total requirement
LOWER60SECSUPPLYPRICE	NUMBER(15,5)		Not used since Dec 2003. Supply price of lower 60 sec
LOWER6SECDISPATCH	NUMBER(15,5)		Not used since Dec 2003. Lower 6 sec MW dispatch
LOWER6SECIMPORT	NUMBER(15,5)		Not used since Dec 2003. Lower 6 sec MW imported
LOWER6SECLOCALDISPATCH	NUMBER(15,5)		Lower 6 sec local dispatch

LOWER6SECLocalPRICE	NUMBER(15,5)		Not used since Dec 2003. Local price of lower 6 sec
LOWER6SECLocalREQ	NUMBER(15,5)		Not used since Dec 2003. Lower 6 sec local requirement
LOWER6SECPRICE	NUMBER(15,5)		Not used since Dec 2003. Regional price of lower 6 sec
LOWER6SECREQ	NUMBER(15,5)		Not used since Dec 2003. Lower 6 sec total requirement
LOWER6SECSUPPLYPRICE	NUMBER(15,5)		Not used since Dec 2003. Supply price of lower 6 sec
RAISE5MINDISPATCH	NUMBER(15,5)		Not used since Dec 2003. Raise 5 min MW dispatch
RAISE5MINIMPORT	NUMBER(15,5)		Not used since Dec 2003. Raise 5 min MW imported
RAISE5MINLOCALDISPATCH	NUMBER(15,5)		Raise 5 min local dispatch
RAISE5MINLOCALPRICE	NUMBER(15,5)		Not used since Dec 2003. Local price of raise 5 min
RAISE5MINLOCALREQ	NUMBER(15,5)		Not used since Dec 2003. Raise 5 min local requirement
RAISE5MINPRICE	NUMBER(15,5)		Not used since Dec 2003. Regional price of raise 5 min
RAISE5MINREQ	NUMBER(15,5)		Not used since Dec 2003. Raise 5 min total requirement
RAISE5MINSUPPLYPRICE	NUMBER(15,5)		Not used since Dec 2003. Supply price of raise 5 min
RAISE60SECDISPATCH	NUMBER(15,5)		Not used since Dec 2003. Raise 60 sec MW dispatch

RAISE60SECIMPORT	NUMBER(15,5)		Not used since Dec 2003. Raise 60 sec MW imported
RAISE60SECLOCALDISPATCH	NUMBER(15,5)		Raise 60 sec local dispatch
RAISE60SECLOCALPRICE	NUMBER(15,5)		Not used since Dec 2003. Local price of raise 60 sec
RAISE60SECLOCALREQ	NUMBER(15,5)		Not used since Dec 2003. Raise 60 sec local requirement
RAISE60SECPRICE	NUMBER(15,5)		Not used since Dec 2003. Regional price of raise 60 sec
RAISE60SECREQ	NUMBER(15,5)		Not used since Dec 2003. Raise 60 sec total requirement
RAISE60SECSUPPLYPRICE	NUMBER(15,5)		Not used since Dec 2003. Supply price of raise 60 sec
RAISE6SECDISPATCH	NUMBER(15,5)		Not used since Dec 2003. Raise 6 sec MW dispatch
RAISE6SECIMPORT	NUMBER(15,5)		Not used since Dec 2003. Raise 6 sec MW imported
RAISE6SECLOCALDISPATCH	NUMBER(15,5)		Raise 6 sec local dispatch
RAISE6SECLOCALPRICE	NUMBER(15,5)		Not used since Dec 2003. Local price of raise 6 sec
RAISE6SECLOCALREQ	NUMBER(15,5)		Not used since Dec 2003. Raise 6 sec local requirement
RAISE6SECPRICE	NUMBER(15,5)		Not used since Dec 2003. Regional price of raise 6 sec
RAISE6SECREQ	NUMBER(15,5)		Not used since Dec 2003. Raise 6 sec total requirement

RAISE6SECSUPPLYPRICE	NUMBER(15,5)		Not used since Dec 2003. Supply price of raise 6 sec
LASTCHANGED	DATE		Period date and time
DATETIME	DATE	X	Period expressed as Date/Time
INITIALSUPPLY	NUMBER(15,5)		Sum of initial generation and import for region
CLEAREDSUPPLY	NUMBER(15,5)		Sum of cleared generation and import for region
LOWERREGIMPORT	NUMBER(15,5)		Not used since Dec 2003. Lower Regulation MW imported
LOWERREGLOCALDISPATCH	NUMBER(15,5)		Lower Regulation local dispatch
LOWERREGLOCALREQ	NUMBER(15,5)		Not used since Dec 2003. Lower Regulation local requirement
LOWERREGREQ	NUMBER(15,5)		Not used since Dec 2003. Lower Regulation total requirement
RAISEREGIMPORT	NUMBER(15,5)		Not used since Dec 2003. Raise Regulation MW imported
RAISEREGLOCALDISPATCH	NUMBER(15,5)		Raise Regulation local dispatch
RAISEREGLOCALREQ	NUMBER(15,5)		Not used since Dec 2003. Raise Regulation local requirement
RAISEREGREQ	NUMBER(15,5)		Not used since Dec 2003. Raise Regulation total requirement
RAISE5MINLOCALVIOLATION	NUMBER(15,5)		Not used since Dec 2003. Violation (MW) of Raise 5 min local requirement
RAISEREGLOCALVIOLATION	NUMBER(15,5)		Not used since Dec 2003. Violation (MW) of Raise Reg local

			requirement
RAISE60SECLOCALVIOLATION	NUMBER(15,5)		Not used since Dec 2003. Violation (MW) of Raise 60 sec local requirement
RAISE6SECLOCALVIOLATION	NUMBER(15,5)		Not used since Dec 2003. Violation (MW) of Raise 6 sec local requirement
LOWER5MINLOCALVIOLATION	NUMBER(15,5)		Not used since Dec 2003. Violation (MW) of Lower 5 min local requirement
LOWERREGLOCALVIOLATION	NUMBER(15,5)		Not used since Dec 2003. Violation (MW) of Lower Reg local requirement
LOWER60SECLOCALVIOLATION	NUMBER(15,5)		Not used since Dec 2003. Violation (MW) of Lower 60 sec local requirement
LOWER6SECLOCALVIOLATION	NUMBER(15,5)		Not used since Dec 2003. Violation (MW) of Lower 6 sec local requirement
RAISE5MINVIOLATION	NUMBER(15,5)		Not used since Dec 2003. Violation (MW) of Raise 5 min requirement
RAISEREGVIOLATION	NUMBER(15,5)		Not used since Dec 2003. Violation (MW) of Raise Reg requirement
RAISE60SECVIOLATION	NUMBER(15,5)		Not used since Dec 2003. Violation (MW) of Raise 60 seconds requirement
RAISE6SECVIOLATION	NUMBER(15,5)		Not used since Dec 2003. Violation (MW) of Raise 6 seconds requirement
LOWER5MINVIOLATION	NUMBER(15,5)		Not used since Dec 2003. Violation (MW) of Lower 5 min requirement

LOWERREGVIOLATION	NUMBER(15,5)		Not used since Dec 2003. Violation (MW) of Lower Reg requirement
LOWER60SECVIOLATION	NUMBER(15,5)		Not used since Dec 2003. Violation (MW) of Lower 60 seconds requirement
LOWER6SECVIOLATION	NUMBER(15,5)		Not used since Dec 2003. Violation (MW) of Lower 6 seconds requirement
RAISE6SECACTUALAVAILABILITY	NUMBER(16,6)		trapezium adjusted raise 6sec availability
RAISE60SECACTUALAVAILABILITY	NUMBER(16,6)		trapezium adjusted raise 60sec availability
RAISE5MINACTUALAVAILABILITY	NUMBER(16,6)		trapezium adjusted raise 5min availability
RAISEREGACTUALAVAILABILITY	NUMBER(16,6)		trapezium adjusted raise reg availability
LOWER6SECACTUALAVAILABILITY	NUMBER(16,6)		trapezium adjusted lower 6sec availability
LOWER60SECACTUALAVAILABILITY	NUMBER(16,6)		trapezium adjusted lower 60sec availability
LOWER5MINACTUALAVAILABILITY	NUMBER(16,6)		trapezium adjusted lower 5min availability
LOWERREGACTUALAVAILABILITY	NUMBER(16,6)		trapezium adjusted lower reg availability
DECAVAILABILITY	NUMBER(16,6)		generation availability taking into account daily energy constraints
LORSURPLUS	NUMBER(16,6)		Not used after Feb 2006. Total short term generation capacity reserve used in assessing lack of reserve condition

LRCSURPLUS	NUMBER(16,6)		Not used after Feb 2006. Total short term generation capacity reserve above the stated low reserve condition requirement
TOTALINTERMITTENTGENERATION	NUMBER(15,5)		Allowance made for non-scheduled generation in the demand forecast (MW).
DEMAND_AND_NONSCHEDULEDGEN	NUMBER(15,5)		Sum of Cleared Scheduled generation, imported generation (at the region boundary) and allowances made for non-scheduled generation (MW).
UIGF	NUMBER(15,5)		Regional aggregated Unconstrained Intermittent Generation Forecast of Semi-scheduled generation (MW).
SEMISCHEDULE_CLEARED MW	NUMBER(15,5)		Regional aggregated Semi-Schedule generator Cleared MW
SEMISCHEDULE_COMPLIANCE MW	NUMBER(15,5)		Regional aggregated Semi-Schedule generator Cleared MW where Semi-Dispatch cap is enforced
SS_SOLAR_UIGF	Number(15,5)		Regional aggregated Unconstrained Intermittent Generation Forecast of Semi-scheduled generation (MW) where the primary fuel source is solar
SS_WIND_UIGF	Number (15,5)		Regional aggregated Unconstrained Intermittent Generation Forecast of Semi-scheduled generation (MW) where the primary fuel source is wind
SS_SOLAR_CLEAREDMW	Number(15,5)		Regional aggregated Semi-

			Schedule generator Cleared MW where the primary fuel source is solar
SS_WIND_CLEAREDMW	Number(15,5)		Regional aggregated Semi-Schedule generator Cleared MW where the primary fuel source is wind
SS_SOLAR_COMPLIANCEMW	Number(15,5)		Regional aggregated Semi-Schedule generator Cleared MW where Semi-Dispatch cap is enforced and the primary fuel source is solar
SS_WIND_COMPLIANCEMW	Number(15,5)		Regional aggregated Semi-Schedule generator Cleared MW where Semi-Dispatch cap is enforced and the primary fuel source is wind

23.16 Table: PREDISPATCHSCENARIODEMAND

23.16.1 PREDISPATCHSCENARIODEMAND

Name	PREDISPATCHSCENARIODEMAND
Comment	PREDISPATCHSCENARIODEMAND defines the demand offsets that are applied for each of the predispatch sensitivity scenarios.

23.16.2 Primary Key Columns

Name
EFFECTIVEDATE
REGIONID
SCENARIO
VERSIONNO

23.16.3 Content

Name	Data Type	Mandatory	Comment
EFFECTIVEDATE	DATE	X	The effective date of this set of scenarios
VERSIONNO	NUMBER(3)	X	The version of this set of scenarios
SCENARIO	NUMBER(2)	X	The scenario identifier.
REGIONID	VARCHAR(20)	X	The region to which to apply the deltaMW for this SCENARIO.
DELTAMW	NUMBER(4)		The MW offset that is applied for this scenario

23.17 Table: PREDISPATCHSCENARIODEMANDTRK

23.17.1 PREDISPATCHSCENARIODEMANDTRK

Name PREDISPATCHSCENARIODEMANDTRK

Comment Tracks the predispach scenario offset updates across time

23.17.2 Primary Key Columns

Name

EFFECTIVEDATE

VERSIONNO

23.17.3 Index Columns

Name

LASTCHANGED

23.17.4 Content

Name	Data Type	Mandatory	Comment
EFFECTIVEDATE	DATE	X	The effective date of this set of scenarios
VERSIONNO	NUMBER(3)	X	The version of this set of scenarios
AUTHORISED BY	VARCHAR(15)		The user that authorised the scenario update
AUTHORISED DATE	DATE		The datetime that the scenario update was authorised
LASTCHANGED	DATE		The datetime that the record was

			last changed
--	--	--	--------------

24 Package: RESERVE_DATA

<i>Name</i>	RESERVE_DATA
<i>Comment</i>	Energy and FCAS reserve requirements

24.1 List of tables

Name	Comment
MTPASA_RESERVELIMIT	MT PASA input table defining a MT PASA Reserve Requirement within a single set. An MT PASA Reserve Requirement can span more than one region.
MTPASA_RESERVELIMIT_REGION	MT PASA input table to define the regions that are part of a single MT PASA Reserve Requirement
MTPASA_RESERVELIMIT_SET	MT PASA input table defining a set of MT PASA Reserve Requirements. Note only one set can be active on a given date.
RESERVE	RESERVE sets out specific reserve requirements for dispatch, predispach and STPASA, for each half-hour interval by region. Updates show as new versions for a date.

24.2 Diagram: Entities: Reserve Data

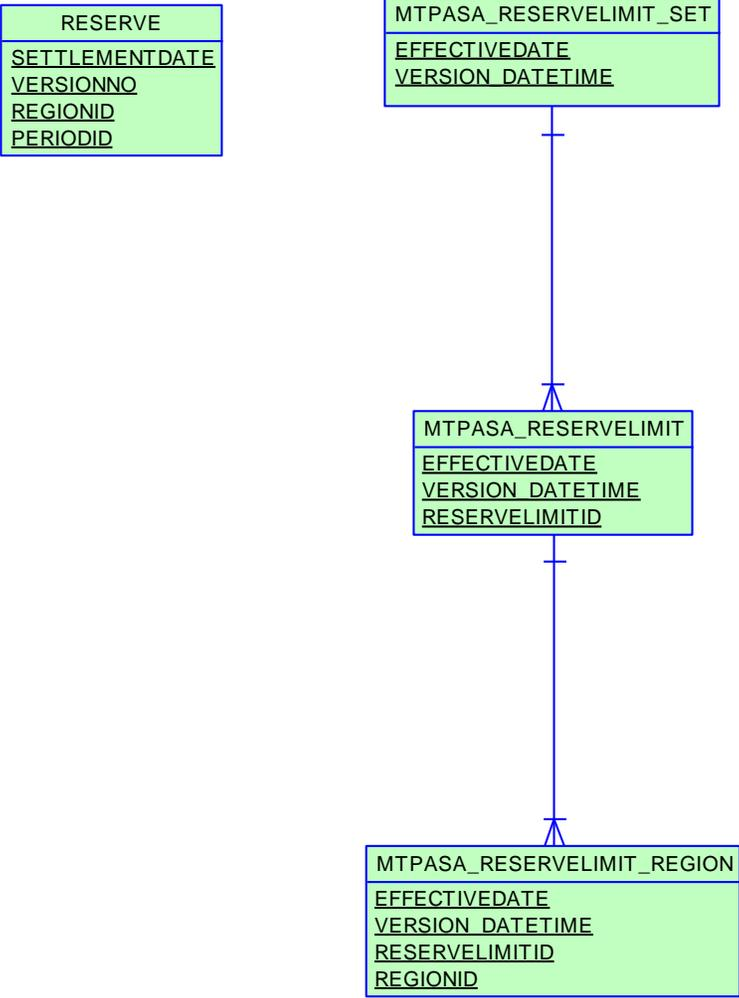

24.3 Table: MTPASA_RESERVELIMIT

24.3.1 MTPASA_RESERVELIMIT

Name MTPASA_RESERVELIMIT

Comment MT PASA input table defining a MT PASA Reserve Requirement within a single set. An MT PASA Reserve Requirement can span more than one region.

24.3.2 Description

Source

MTPASA_RESERVELIMIT is updated on an ad hoc basis when a new Reserve Requirement is published.

Volume

~20 rows per year

24.3.3 Notes

Name	Comment	Value
Visibility	Data in this table is:	Public

24.3.4 Primary Key Columns

Name

EFFECTIVEDATE

RESERVELIMITID

VERSION_DATETIME

24.3.5 Content

Name	Data Type	Mandatory	Comment
------	-----------	-----------	---------

EFFECTIVEDATE	DATE	X	Trade date when the set of reserve requirements become effective
VERSION_DATETIME	DATE	X	Timestamp when the set of reserve requirements become effective
RESERVELIMITID	VARCHAR2(20))	X	MT PASA Reserve Requirement identifier
DESCRIPTION	VARCHAR2(20 0)		Description of this Reserve Requirement
RHS	NUMBER(16,6)		Right hand side value for this Reserve requirement
LASTCHANGED	DATE		Timestamp the record was last modified.

24.4 Table: MTPASA_RESERVELIMIT_REGION

24.4.1 MTPASA_RESERVELIMIT_REGION

Name MTPASA_RESERVELIMIT_REGION

Comment MT PASA input table to define the regions that are part of a single MT PASA Reserve Requirement

24.4.2 Description

Source

MTPASA_RESERVELIMIT_REGION is updated on an ad hoc basis when a new Reserve Requirement is published.

Volume

~50 rows per year

24.4.3 Notes

Name	Comment	Value
Visibility	Data in this table is:	Public

24.4.4 Primary Key Columns

Name

EFFECTIVEDATE

REGIONID

RESERVELIMITID

VERSION_DATETIME

24.4.5 Content

Name	Data Type	Mandatory	Comment

EFFECTIVEDATE	DATE	X	Trade date when the set of reserve requirements become effective
VERSION_DATETIME	DATE	X	Timestamp when the set of reserve requirements become effective
RESERVELIMITID	VARCHAR2(20))	X	MT PASA Reserve requirement identifier
REGIONID	VARCHAR2(20))	X	Region ID - identifier of a NEM region included in this requirement
COEF	NUMBER(16,6)		Coefficient for the region in this reserve requirement
LASTCHANGED	DATE		Timestamp the record was last modified

24.5 Table: MTPASA_RESERVELIMIT_SET

24.5.1 MTPASA_RESERVELIMIT_SET

Name	MTPASA_RESERVELIMIT_SET
Comment	MT PASA input table defining a set of MT PASA Reserve Requirements. Note only one set can be active on a given date.

24.5.2 Description

Source

MTPASA_RESERVELIMIT_SET is updated on an ad hoc basis when a new Reserve Requirement is published.

Volume

~2 rows per year

24.5.3 Notes

Name	Comment	Value
Visibility	Data in this table is:	Public

24.5.4 Primary Key Columns

Name

EFFECTIVEDATE

VERSION_DATETIME

24.5.5 Content

Name	Data Type	Mandatory	Comment
EFFECTIVEDATE	DATE	X	Trade date when the set of reserve requirements become effective
VERSION_DATETIME	DATE	X	Timestamp when the set of reserve

			requirements become effective
RESERVELIMIT_SET_ID	VARCHAR2(20)		MT PASA LRC Reserve Requirement Set Identifier
DESCRIPTION	VARCHAR2(20 0)		Description of this set of Reserve Requirements
AUTHORISEDDATE	DATE		Date the requirement set was authorised
AUTHORISEDBY	VARCHAR2(20)		User authorising this requirement set
LASTCHANGED	DATE		Timestamp the record was last modified

24.6 Table: RESERVE

24.6.1 RESERVE

Name	RESERVE
Comment	RESERVE sets out specific reserve requirements for dispatch, predispatch and STPASA, for each half-hour interval by region. Updates show as new versions for a date.

24.6.2 Description

Two fields specify Frequency Controlled Ancillary Services requirements for the regulation ancillary services. Another two fields specify the Lack of Reserve levels to be applied in the ST PASA solver.

Change Notice 324 (for the FCAS Constraint enhancements project) means that Dispatch no longer utilises the static FCAS requirements defined in the DELTAMW and RESERVE tables. These tables are replaced with constraint data as a source of FCAS requirements.

RESERVE data is public, so is available to all participants.

Source

RESERVE updates as AEMO updates forecasts, daily.

24.6.3 Notes

Name	Comment	Value
Visibility	Data in this table is:	Public

24.6.4 Primary Key Columns

- Name
- PERIODID
- REGIONID
- SETTLEMENTDATE
- VERSIONNO

24.6.5 Index Columns

Name

LASTCHANGED

24.6.6 Content

Name	Data Type	Mandatory	Comment
SETTLEMENTDATE	DATE	X	Market date starting at 04:00am
VERSIONNO	NUMBER(3,0)	X	Version No of record for this date, the version of the file loaded to produce these reserve figures
REGIONID	VARCHAR2(12)	X	Differentiates this region from all other regions
PERIODID	NUMBER(2,0)	X	Market Trading Interval
LOWER5MIN	NUMBER(6,0)		Lower 5 minute reserve requirement
LOWER60SEC	NUMBER(6,0)		Lower 60 second reserve requirement
LOWER6SEC	NUMBER(6,0)		Lower 6 second reserve requirement
RAISE5MIN	NUMBER(6,0)		Raise 5 minute reserve requirement
RAISE60SEC	NUMBER(6,0)		Raise 60 second reserve requirement
RAISE6SEC	NUMBER(6,0)		Raise 6 second reserve requirement

LASTCHANGED	DATE		Last date and time record changed
PASARESERVE	NUMBER(6,0)		PASA reserve requirement
LOADREJECTIONRESERVE EQ	NUMBER(10,0)		PASA Load rejection reserve requirement
RAISEREG	NUMBER(6,0)		Raise Regulation reserve requirement
LOWERREG	NUMBER(6,0)		Lower Regulation reserve requirement
LOR1LEVEL	NUMBER(6,0)		PASA Lack of Reserve 1 Level
LOR2LEVEL	NUMBER(6,0)		PASA Lack of Reserve 1 Level

25 Package: SETTLEMENT_CONFIG

<i>Name</i>	SETTLEMENT_CONFIG
<i>Comment</i>	Configuration and input data for the Settlements Process

25.1 List of tables

Name	Comment
ANCILLARY_RECOVERY_SPLIT	ANCILLARY_RECOVERY_SPLIT holds the actual customer portion for each service and payment type. A single EFFECTIVEDATE/VERSIONNO combination applies to all services (i.e. the latest EFFECTIVEDATE/VERSIONNO is not retrieved for a single service, but applies to a data set).
MARKET_FEE_CAT_EXCL	Market fee exclusions for participant categories.
MARKET_FEE_CAT_EXCL_TRK	Tracking table for market fee exclusions for participant categories.
MARKET_FEE_EXCLUSION	MARKET_FEE_EXCLUSION shows the list of market fees from which a participant is excluded from funding after a particular settlement date.
MARKET_FEE_EXCLUSIONTRK	MARKET_FEE_EXCLUSIONTRK shows authorisation details of participant market fee exclusion data sets.
MARKETFEE	MARKETFEE sets out fee type and period for each market fee.
MARKETFEEDATA	MARKETFEEDATA sets out actual fee rates, as adjusted from time to time.
MARKETFEETRK	MARKETFEETRK sets out versions of each market fee used and its effective date.
PARTICIPANT_BANDFEE_ALLOC	PARTICIPANT_BANDFEE_ALLOC shows the market fee

	for each Participant/Participant Category over time.
REALLOCATION	The REALLOCATION table shows the financial transactions agreed between two participants that are settled through the AEMO pool settlements process.
REALLOCATIONINTERVAL	Half-hour data comprising a single reallocation transaction.
SETCFG_PARTICIPANT_MPF	SETCFG_PARTICIPANT_MPF shows the Market Participation Factors (MPF) for each participant for each connection point. The MPF values are used to determine recovery amounts for regulation FCAS.
SETCFG_PARTICIPANT_MPFTRK	SETCFG_PARTICIPANT_MPFTRK is the tracking table for Market Participation Factors (MPF) data stored in the SETCFG_PARTICIPANT_MPF table for each participant.

25.2 Diagram: Entities: Settlement Config

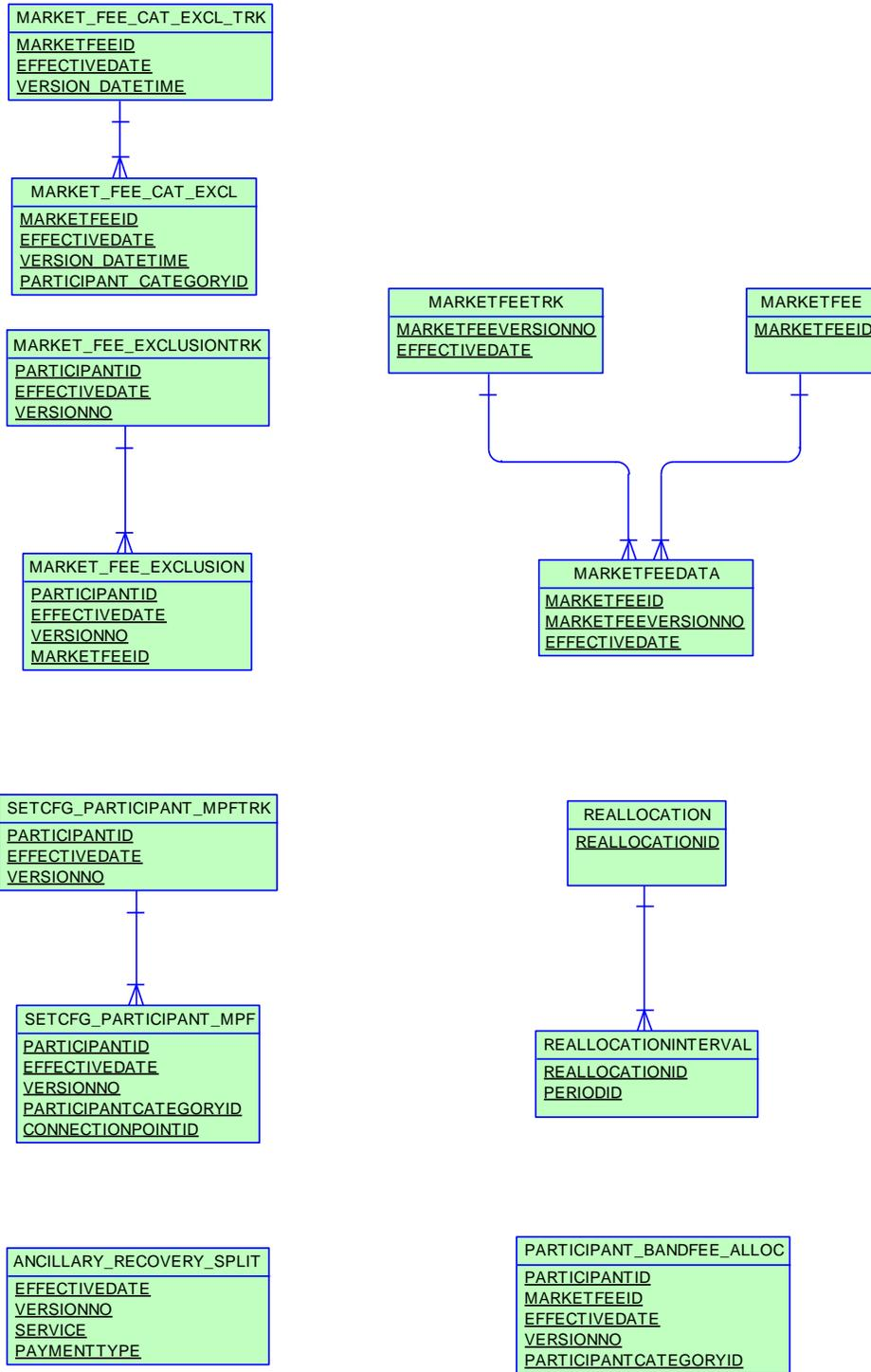

25.3 Table: ANCILLARY_RECOVERY_SPLIT

25.3.1 ANCILLARY_RECOVERY_SPLIT

Name	ANCILLARY_RECOVERY_SPLIT
Comment	ANCILLARY_RECOVERY_SPLIT holds the actual customer portion for each service and payment type. A single EFFECTIVEDATE/VERSIONNO combination applies to all services (i.e. the latest EFFECTIVEDATE/VERSIONNO is not retrieved for a single service, but applies to a data set).

25.3.2 Description

ANCILLARY_RECOVERY_SPLIT is public data, and is available to all participants.

Source

This table is updated infrequently.

25.3.3 Notes

Name	Comment	Value
Visibility	Data in this table is:	Public

25.3.4 Primary Key Columns

- Name
- EFFECTIVEDATE
- PAYMENTTYPE
- SERVICE
- VERSIONNO

25.3.5 Index Columns

Name

LASTCHANGED

25.3.6 Content

Name	Data Type	Mandatory	Comment
EFFECTIVEDATE	DATE	X	Calendar settlement date record becomes effective.
VERSIONNO	NUMBER(3,0)	X	Version number of the record for the given date.
SERVICE	VARCHAR2(10)	X	Ancillary service name (e.g. AGC, FCASCOMP)
PAYMENTTYPE	VARCHAR2(20)	X	A payment type associated with the service (can be ENABLING, AVAILABILITY, USAGE, or COMPENSATION).
CUSTOMER_PORTION	NUMBER(8,5)		The percentage value of the recovery funded by market customers.
LASTCHANGED	DATE		Last date and time record changed

25.4 Table: MARKET_FEE_CAT_EXCL

25.4.1 MARKET_FEE_CAT_EXCL

Name	MARKET_FEE_CAT_EXCL
Comment	Market fee exclusions for participant categories.

25.4.2 Notes

Name	Comment	Value
Visibility	Data in this table is:	Public

25.4.3 Primary Key Columns

Name
EFFECTIVEDATE
MARKETFEEID
PARTICIPANT_CATEGORYID
VERSION_DATETIME

25.4.4 Content

Name	Data Type	Mandatory	Comment
MARKETFEEID	VARCHAR2(20)	X	The excluded market fee
EFFECTIVEDATE	DATE	X	The date the exclusion is effective from
VERSION_DATETIME	DATE	X	The version information for this record

PARTICIPANT_CATEGORYI D	VARCHAR2(20)	X	Participant category to be excluded from this market fee
----------------------------	------------------	---	---

25.5 Table: MARKET_FEE_CAT_EXCL_TRK

25.5.1 MARKET_FEE_CAT_EXCL_TRK

Name MARKET_FEE_CAT_EXCL_TRK
 Comment Tracking table for market fee exclusions for participant categories.

25.5.2 Notes

Name Comment Value
 Visibility Data in this table is: Public

25.5.3 Primary Key Columns

Name
 EFFECTIVEDATE
 MARKETFEEID
 VERSION_DATETIME

25.5.4 Content

Name	Data Type	Mandatory	Comment
MARKETFEEID	VARCHAR2(20)	X	The excluded market fee
EFFECTIVEDATE	DATE	X	The date the exclusion is effective from
VERSION_DATETIME	DATE	X	The version information for this record
LASTCHANGED	DATE		Last date and time the record

			changed
--	--	--	---------

25.6 Table: MARKET_FEE_EXCLUSION

25.6.1 MARKET_FEE_EXCLUSION

Name	MARKET_FEE_EXCLUSION
Comment	MARKET_FEE_EXCLUSION shows the list of market fees from which a participant is excluded from funding after a particular settlement date.

25.6.2 Description

MARKET_FEE_EXCLUSION data is confidential to the relevant participant.

Source

MARKET_FEE_EXCLUSION updates only on change of participant configuration.

25.6.3 Notes

Name	Comment	Value
Visibility	Data in this table is:	Private

25.6.4 Primary Key Columns

- Name
- EFFECTIVEDATE
- MARKETFEEID
- PARTICIPANTID
- VERSIONNO

25.6.5 Index Columns

- Name

LASTCHANGED

25.6.6 Content

Name	Data Type	Mandatory	Comment
PARTICIPANTID	VARCHAR2(10)	X	Unique participant identifier
EFFECTIVEDATE	DATE	X	Date on which this data becomes effective
VERSIONNO	NUMBER(3,0)	X	Version of fees for this ID
MARKETFEEID	VARCHAR2(10)	X	Identifier for Market Fee
LASTCHANGED	DATE		Last date and time record changed

25.7 Table: MARKET_FEE_EXCLUSIONTRK

25.7.1 MARKET_FEE_EXCLUSIONTRK

Name	MARKET_FEE_EXCLUSIONTRK
Comment	MARKET_FEE_EXCLUSIONTRK shows authorisation details of participant market fee exclusion data sets.

25.7.2 Description

MARKET_FEE_EXCLUSIONTRK is confidential to the participant.

Source

MARKET_FEE_EXCLUSIONTRK updates only on change of participant configuration.

25.7.3 Notes

Name	Comment	Value
Visibility	Data in this table is:	Private

25.7.4 Primary Key Columns

Name
EFFECTIVEDATE
PARTICIPANTID
VERSIONNO

25.7.5 Index Columns

Name
LASTCHANGED

25.7.6 Content

Name	Data Type	Mandatory	Comment
PARTICIPANTID	VARCHAR2(10)	X	Unique participant identifier
EFFECTIVEDATE	DATE	X	Date on which this data becomes effective
VERSIONNO	NUMBER(3,0)	X	Version of fees for this ID
AUTHORISED BY	VARCHAR2(15)		User authorising record
AUTHORISED DATE	DATE		Date record authorised
LASTCHANGED	DATE		Last date and time record changed

25.8 Table: MARKETFEE

25.8.1 MARKETFEE

Name	MARKETFEE
Comment	MARKETFEE sets out fee type and period for each market fee.

25.8.2 Description

MARKETFEE data is public, so is available to all participants.

Source

MARKETFEE updates when fees change.

25.8.3 Notes

Name	Comment	Value
Visibility	Data in this table is:	Public

25.8.4 Primary Key Columns

Name
MARKETFEEID

25.8.5 Index Columns

Name
LASTCHANGED

25.8.6 Content

Name	Data Type	Mandatory	Comment

MARKETFEEID	VARCHAR2(10)	X	Identifier for Market Fee
MARKETFEERIOD	VARCHAR2(20)		Period type - PERIOD, DAILY, WEEKLY
MARKETFEETYPE	VARCHAR2(12)		Type - MW or \$
DESCRIPTION	VARCHAR2(64)		Description of market fee
LASTCHANGED	DATE		Last date and time record changed
GL_TCODE	VARCHAR2(15)		
GL_FINANCIALCODE	VARCHAR2(10)		
FEE_CLASS	VARCHAR2(40)		

25.9 Table: MARKETFEEDATA

25.9.1 MARKETFEEDATA

Name	MARKETFEEDATA
Comment	MARKETFEEDATA sets out actual fee rates, as adjusted from time to time.

25.9.2 Description

MARKETFEEDATA is public data, and is available to all participants.

Source

MARKETFEEDATA updates whenever fee rates change.

25.9.3 Notes

Name	Comment	Value
Visibility	Data in this table is:	Public

25.9.4 Primary Key Columns

Name

EFFECTIVEDATE

MARKETFEEID

MARKETFEEVERSIONNO

25.9.5 Index Columns

Name

LASTCHANGED

25.9.6 Content

Name	Data Type	Mandatory	Comment
MARKETFEEID	VARCHAR2(10)	X	Identifier for Market Fee
MARKETFEEVERSIONNO	NUMBER(3,0)	X	Version of fees for this id
EFFECTIVEDATE	DATE	X	Date on which this data becomes effective
MARKETFEEVALUE	NUMBER(22,8)		Market fee rate/MWh, a dollar amount
LASTCHANGED	DATE		Last date and time record changed

25.10 Table: MARKETFEETRK

25.10.1 MARKETFEETRK

Name	MARKETFEETRK
Comment	MARKETFEETRK sets out versions of each market fee used and its effective date.

25.10.2 Description

MARKETFEETRK data is public, so is available to all participants.

Source

MARKETFEETRK updated infrequently, when new annual rates must be inserted.

Volume

One record inserted per year.

25.10.3 Notes

Name	Comment	Value
Visibility	Data in this table is:	Public

25.10.4 Primary Key Columns

Name
 EFFECTIVEDATE
 MARKETFEEVERSIONNO

25.10.5 Index Columns

Name
 LASTCHANGED

25.10.6 Content

Name	Data Type	Mandatory	Comment
MARKETFEEVERSIONNO	NUMBER(3,0)	X	Version of fees for this ID
EFFECTIVEDATE	DATE	X	Effective Date of Market notice
AUTHORISED BY	VARCHAR2(15)		User authorising record
AUTHORISED DATE	DATE		Date record authorised
LASTCHANGED	DATE		Last date and time record changed

25.11 Table: PARTICIPANT_BANDFEE_ALLOC

25.11.1 PARTICIPANT_BANDFEE_ALLOC

Name	PARTICIPANT_BANDFEE_ALLOC
Comment	PARTICIPANT_BANDFEE_ALLOC shows the market fee for each Participant/Participant Category over time.

25.11.2 Description

Source

This view updates only on change of participant configuration.

25.11.3 Notes

Name	Comment	Value
Visibility	Data in this table is:	Private

25.11.4 Primary Key Columns

Name
 EFFECTIVEDATE
 MARKETFEEID
 PARTICIPANTCATEGORYID
 PARTICIPANTID
 VERSIONNO

25.11.5 Index Columns

Name
 LASTCHANGED

25.11.6 Content

Name	Data Type	Mandatory	Comment
PARTICIPANTID	VARCHAR2(10)	X	Unique participant identifier
MARKETFEEID	VARCHAR2(10)	X	Identifier for Market Fee
EFFECTIVEDATE	DATE	X	Date on which this data becomes effective.
VERSIONNO	NUMBER(3,0)	X	Period identifier
PARTICIPANTCATEGORYID	VARCHAR2(10)	X	The participant category that the market fee recovery amount pertains to.
MARKETFEEVALUE	NUMBER(15,5)		The value of this market fee
LASTCHANGED	DATE		Last date and time record changed

25.12 Table: REALLOCATION

25.12.1 REALLOCATION

Name REALLOCATION

Comment The REALLOCATION table shows the financial transactions agreed between two participants that are settled through the AEMO pool settlements process.

25.12.2 Description

Note

The column REALLOCATION_TYPE can be used in conjunction with CREDITPARTICIPANT or DEBITPARTICIPANT to determine who submitted a reallocation.

25.12.3 Notes

Name Comment Value

Visibility Data in this table is: Private

25.12.4 Primary Key Columns

Name
REALLOCATIONID

25.12.5 Index Columns

Name
LASTCHANGED

25.12.6 Content

Name	Data Type	Manda	Comment
------	-----------	-------	---------

		tory	
REALLOCATIONID	VARCHAR2(20))	X	Reallocation identifier
CREDITPARTICIPANTID	VARCHAR2(10))		The participant to be credited for the reallocation
DEBITPARTICIPANTID	VARCHAR2(10))		The participant to be debited for the reallocation
REGIONID	VARCHAR2(10))		Region identifier, being the spot price reference node for this reallocation
AGREEMENTTYPE	VARCHAR2(10))		\$(Quantity) Mwh, SWAP, CAP or FLOOR
CREDITREFERENCE	VARCHAR2(400)		Optional reference detail for credit participant
DEBITREFERENCE	VARCHAR2(400)		Optional reference detail for debit participant
LASTCHANGED	DATE		Last date and time record changed
STARTDATE	DATE		First day of the Reallocation contract
ENDDATE	DATE		Last day of the Reallocation contract
CURRENT_STEPID	VARCHAR2(20))		Reallocation state. One of SUBMITTED, AUTHORISED, CANCELLED.
DAYTYPE	VARCHAR2(20))		The day type profile for which the reallocation applies over the start and end date range. Valid entries are BUSINESS, NON_BUSINESS or FLAT.

REALLOCATION_TYPE	VARCHAR2(1)		Denotes a Credit or Debit reallocation with a value of "C" or "D" respectively
-------------------	-------------	--	--

25.13 Table: REALLOCATIONINTERVAL

25.13.1 REALLOCATIONINTERVAL

Name	REALLOCATIONINTERVAL
Comment	Half-hour data comprising a single reallocation transaction.

25.13.2 Notes

Name	Comment	Value
Visibility	Data in this table is:	Private

25.13.3 Primary Key Columns

Name
PERIODID
REALLOCATIONID

25.13.4 Index Columns

Name
LASTCHANGED

25.13.5 Content

Name	Data Type	Mandatory	Comment
REALLOCATIONID	VARCHAR2(20)	X	Reallocation identifier
PERIODID	NUMBER(3)	X	Period identifier (1..48)

VALUE	NUMBER(15,5)		Reallocation value in the units of the agreement type
LASTCHANGED	DATE		Last date and time record changed
NRP	NUMBER(15,5)		Nominated Reallocation Price, only used in agreement types of SWAP, CAP and FLOOR, being the contract strike price in \$/MWh

25.14 Table: SETCFG_PARTICIPANT_MPF

25.14.1 SETCFG_PARTICIPANT_MPF

Name	SETCFG_PARTICIPANT_MPF
Comment	SETCFG_PARTICIPANT_MPF shows the Market Participation Factors (MPF) for each participant for each connection point. The MPF values are used to determine recovery amounts for regulation FCAS.

25.14.2 Description

SETCFG_PARTICIPANT_MPF data is available to all participants.

Volume

Approximately 20,000 records per year

25.14.3 Notes

Name	Comment	Value
Visibility	Data in this table is:	Public

25.14.4 Primary Key Columns

- Name
- CONNECTIONPOINTID
- EFFECTIVEDATE
- PARTICIPANTCATEGORYID
- PARTICIPANTID
- VERSIONNO

25.14.5 Index Columns

Name

LASTCHANGED

25.14.6 Content

Name	Data Type	Mandatory	Comment
PARTICIPANTID	VARCHAR2(10)	X	Participant identifier
EFFECTIVEDATE	DATE	X	Effective date of the MPF data
VERSIONNO	NUMBER(3,0)	X	Version number of the MPF data
PARTICIPANTCATEGORYID	VARCHAR2(10)	X	Participant Category
CONNECTIONPOINTID	VARCHAR2(10)	X	Connection point identifier
MPF	NUMBER(15,5)		Market Participation Factor
LASTCHANGED	DATE		Last date and time record changed

25.15 Table: SETCFG_PARTICIPANT_MPFTRK

25.15.1 SETCFG_PARTICIPANT_MPFTRK

Name	SETCFG_PARTICIPANT_MPFTRK
Comment	SETCFG_PARTICIPANT_MPFTRK is the tracking table for Market Participation Factors (MPF) data stored in the SETCFG_PARTICIPANT_MPF table for each participant.

25.15.2 Description

SETCFG_PARTICIPANT_MPFTRK data is public, so is available to all participants.

Volume

Approximately 2,000 records per year

25.15.3 Notes

Name	Comment	Value
Visibility	Data in this table is:	Public

25.15.4 Primary Key Columns

Name
EFFECTIVEDATE
PARTICIPANTID
VERSIONNO

25.15.5 Index Columns

Name
LASTCHANGED

25.15.6 Content

Name	Data Type	Mandatory	Comment
PARTICIPANTID	VARCHAR2(10)	X	Participant identifier
EFFECTIVEDATE	DATE	X	Effective date of the MPF data
VERSIONNO	NUMBER(3,0)	X	Version number of the MPF data
AUTHORISED BY	VARCHAR2(15)		Authorising user
AUTHORISED DATE	DATE		Authorised date and time
LASTCHANGED	DATE		Last date and time record changed

26 Package: SETTLEMENT_DATA

<i>Name</i>	SETTLEMENT_DATA
<i>Comment</i>	Results from a published Settlements Run. The settlement data and billing run data are updated daily between 6am and 8am for AEMO's prudential processes. In a normal week, AEMO publishes one PRELIM, one FINAL and two REVISION runs in addition to the daily runs.

26.1 List of tables

Name	Comment
DAYTRACK	DAYTRACK identifies the actual settlement run processed for each settlement day. Settlement run is in the column EXPOSTRUNNO. Generally the number of the settlement run used in the latest statement is the maximum number.
SET_APC_COMPENSATION	APC Compensation payment amounts in the Settlements timeframe
SET_APC_RECOVERY	APC Compensation recovery amounts in the Settlements timeframe
SET_ANCILLARY_SUMMARY	SET_ANCILLARY_SUMMARY summarises payments for all Ancillary Services to participants on the basis of regions and trading intervals.
SET_FCAS_PAYMENT	SET_FCAS_PAYMENT sets out the enabling payment details for frequency controlled Ancillary Services.
SET_FCAS_RECOVERY	SET_FCAS_RECOVERY shows reimbursements for the Frequency Control Ancillary Services (FCAS) to be recovered from participants. Beware of potential confusion with the table SETFCASRECOVERY, which reports reimbursements for Frequency Control Ancillary Services Compensation (now unused).
SET_FCAS_REGULATION_TRK	SET_FCAS_REGULATION_TRK shows FCAS Regulation

	Service Constraint tracking for Regional FCAS Regulation recovery
SET_MR_PAYMENT	SET_MR_PAYMENT shows trading interval payments on a dispatchable unit basis for accepted MR capacity.
SET_MR_RECOVERY	SET_MR_RECOVERY shows the trading interval recovery charges on a dispatchable unit basis for spot market income from dispatch of MR capacity.
SET_NMAS_RECOVERY	SET_NMAS_RECOVERY sets out the NSCAS recovery data for payments other than testing.
SET_NMAS_RECOVERY_RBF	SET_NMAS_RECOVERY_RBF publishes the RBF for NSCAS non testing payments on a half hourly basis.
SET_RUN_PARAMETER	SET_RUN_PARAMETER shows the input parameters and value associated with each settlement run (e.g. Residual System Load Causer Pays Factor).
SETAGCPAYMENT	SETAGCPAYMENT sets out specific payment details for Automatic Generation Control (AGC) services by period.
SETAGCRECOVERY	SETAGCRECOVERY shows reimbursements for Automatic Generation Control (AGC) Ancillary Services to be recovered from participants.
SETCPDATA	SETCPDATA shows meter settlement data for each connection point. This is the key view for retailers to verify energy charges. A regional summary view is also provided. As the view has values for each connection point by period, for each meter data file, it is a very large view.
SETCPDATAREGION	SETCPDATAREGION sets out summary meter settlement data for each region.
SETFCASCOMP	SETFCASCOMP shows the compensation details for Frequency Controlled Ancillary Services (FCAS). These compensation values are calculated by a separate "what if" run of the LP Solver and entered as an unconstrained MW value into settlements.

SETFCASREGIONRECOVERY	SETFCASREGIONRECOVERY shows FCAS Regional Recovery Data against each Trading Interval.
SETGENDATA	SETGENDATA shows meter settlement data for each generation meter point. A regional summary is also provided.
SETGENDATAREGION	SETGENDATAREGION sets out summary settlement data for generation within the specified region.
SETINTERVENTION	SETINTERVENTION shows intervention settlement payment details by unit.
SETINTERVENTIONRECOVERY	SETINTERVENTIONRECOVERY shows intervention recovery details by participant.
SETINTRAREGIONRESIDUES	
SETIRAUCSURPLUS	This view supports the Settlements Residue Auction, by holding the NSP participant allocations of IRSurplus arising as a result of the unsold units for a quarter.
SETIRFMRECOVERY	SETIRFMRECOVERY sets out reimbursements for Industrial Relations Force Majeure to be recovered from participants.
SETIRNSPSURPLUS	This view supports the Settlements Residue Auction, by showing the TNSP participant allocations of Interconnector Residue (IR) Surplus (i.e. derogated amounts) arising as a result of the sold units for a quarter.
SETIRPARTSURPLUS	This view supports the Settlements Residue Auction, holding the participant allocations of IRSurplus.
SETIRSURPLUS	SETIRSURPLUS records the interregional residue calculation for each interconnector and each side of the interconnector.
SETLSHEDPAYMENT	SETLSHEDPAYMENT shows specific payment details for load shed services by period.

SETLSHEDRECOVERY	SETLSHEDRECOVERY shows reimbursements for Load shed Ancillary Services to be recovered from participants. (Data no longer created for Settlement Days from 01/07/2012)
SETLULOADRECOVERY	SETLULOADRECOVERY shows reimbursements for rapid-unit-load Ancillary Services to be recovered from participants.
SETLUNLOADPAYMENT	SETLUNLOADPAYMENT shows specific payment details for rapid unit unload service.
SETLUNLOADRECOVERY	SETLUNLOADRECOVERY shows reimbursements for rapid unit unloading Ancillary Services to be recovered from participants.
SETMARKETFEEES	SETMARKETFEEES shows payments for market fees for each settlement date.
SETREALLOCATIONS	SETREALLOCATIONS shows the trading interval value of reallocations processed, for those participants whose reallocation submissions have been accepted by AEMO.
SETRESERVERECOVERY	SETRESERVERECOVERY shows reserve recovery details.
SETRESTARTPAYMENT	SETRESTARTPAYMENT shows specific payment details for System Restart services by period.
SETRESTARTRECOVERY	SETRESTARTRECOVERY shows reimbursements for system restart Ancillary Services to be recovered from participants. (Data no longer created for Settlement Days from 01/07/2012)
SETRPOWERPAYMENT	SETRPOWERPAYMENT shows specific payment details for Reactive power services by period.
SETRPOWERRECOVERY	SETRPOWERRECOVERY shows reimbursements for Reactive Power Ancillary Services to be recovered from participants. (Data no longer created for Settlement Days from 01/07/2012)

SETSMALLGENDATA	Publishes metering data and associated settlement values for with a registered Small Generator Aggregator participants connection points.
SETVICBOUNDARYENERGY	SETVICBOUNDARYENERGY is as requested by Participants for the settlement of Victorian Vesting contracts.
SETVICENERGYFIGURES	SETVICENERGYFIGURES is used in settlement of Victorian Vesting contracts.
SETVICENERGYFLOW	SETVICENERGYFLOW is used in settlement of Victorian Vesting contracts.

26.2 Diagram: Entities: Settlement Data

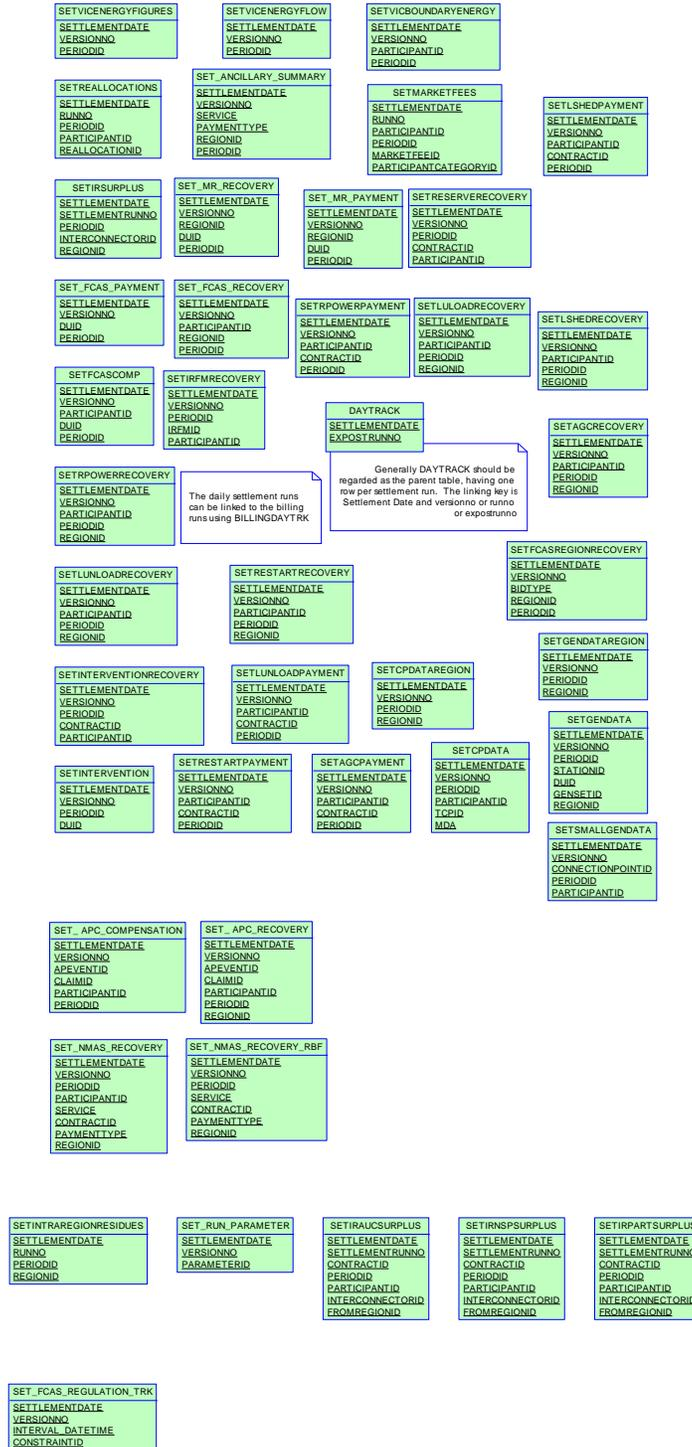

26.3 Table: DAYTRACK

26.3.1 DAYTRACK

Name	DAYTRACK
Comment	DAYTRACK identifies the actual settlement run processed for each settlement day. Settlement run is in the column EXPOSTRUNNO. Generally the number of the settlement run used in the latest statement is the maximum number.

26.3.2 Description

DAYTRACK is a public data, and is available to all participants.

Source

DAYTRACK is populated by the posting of a billing run.

Volume

Daily billing runs insert one row per day. A non-interim statement has seven records inserted per week. An indicative maximum is 35 records inserted per week.

26.3.3 Notes

Name	Comment	Value
Visibility	Data in this table is:	Public

26.3.4 Primary Key Columns

- Name
- EXPOSTRUNNO
- SETTLEMENTDATE

26.3.5 Index Columns

Name

LASTCHANGED

26.3.6 Content

Name	Data Type	Mandatory	Comment
SETTLEMENTDATE	DATE	X	Calendar Settlement Date
REGIONID	VARCHAR2(10)		Not Used
EXANTERUNSTATUS	VARCHAR2(15)		Not Used
EXANTERUNNO	NUMBER(3,0)		Not Used
EXPOSTRUNSTATUS	VARCHAR2(15)		Not Used
EXPOSTRUNNO	NUMBER(3,0)	X	Settlement Run No
LASTCHANGED	DATE		Last date and time record changed

26.4 Table: SET_ APC_COMPENSATION

26.4.1 SET_ APC_COMPENSATION

Name SET_ APC_COMPENSATION

Comment APC Compensation payment amounts in the Settlements timeframe

26.4.2 Notes

Name Comment Value

Visibility Data in this table is: Private

26.4.3 Primary Key Columns

Name

APEVENTID

CLAIMID

PARTICIPANTID

PERIODID

SETTLEMENTDATE

VERSIONNO

26.4.4 Content

Name	Data Type	Mandatory	Comment
SETTLEMENTDATE	DATE	X	Settlement run date
VERSIONNO	NUMBER(3)	X	Settlement run number
APEVENTID	NUMBER(6)	X	AP Event Id

CLAIMID	NUMBER(6)	X	AP Event Claim Id
PARTICIPANTID	VARCHAR2(20)	X	Participant identifier
PERIODID	NUMBER(3)	X	Trading interval identifier
COMPENSATION_AMOUNT	NUMBER(18,8)		Compensation amount for the event claim in this interval

26.5 Table: SET_ APC_RECOVERY

26.5.1 SET_ APC_RECOVERY

Name SET_ APC_RECOVERY

Comment APC Compensation recovery amounts in the Settlements timeframe

26.5.2 Notes

Name Comment Value

Visibility Data in this table is: Private

26.5.3 Primary Key Columns

Name

APEVENTID

CLAIMID

PARTICIPANTID

PERIODID

REGIONID

SETTLEMENTDATE

VERSIONNO

26.5.4 Content

Name	Data Type	Mandatory	Comment
SETTLEMENTDATE	DATE	X	Settlement run date
VERSIONNO	NUMBER(3)	X	Settlement run number

APEVENTID	NUMBER(6)	X	AP Event Id
CLAIMID	NUMBER(6)	X	AP Event Claim Id
PARTICIPANTID	VARCHAR2(20)	X	Participant identifier
PERIODID	NUMBER(3)	X	Trading interval identifier
REGIONID	VARCHAR2(20)	X	Region id for the recovery amount
RECOVERY_AMOUNT	NUMBER(18,8)		Recovery amount in the region attributable to the participant for the event claim in this interval
REGION_RECOVERY_AMOUNT	NUMBER(18,8)		Total Recovery amount in the region for the event claim in this interval

26.6 Table: SET Ancillary Summary

26.6.1 SET Ancillary Summary

Name	SET Ancillary Summary
Comment	SET Ancillary Summary summarises payments for all Ancillary Services to participants on the basis of regions and trading intervals.

26.6.2 Description

SET Ancillary Summary data is available to all participants.

Volume

Approximately 30,000 per week.

26.6.3 Notes

Name	Comment	Value
Visibility	Data in this table is:	Public

26.6.4 Primary Key Columns

Name

PAYMENTTYPE

PERIODID

REGIONID

SERVICE

SETTLEMENTDATE

VERSIONNO

26.6.5 Index Columns

Name

LASTCHANGED

26.6.6 Content

Name	Data Type	Mandatory	Comment
SETTLEMENTDATE	DATE	X	Settlement Date
VERSIONNO	NUMBER(3,0)	X	Settlement Run No
SERVICE	VARCHAR2(20)	X	Ancillary service identifier (e.g. REACTIVE_POWER)
PAYMENTTYPE	VARCHAR2(20)	X	Payment type identifier (e.g. COMPENSATION)
REGIONID	VARCHAR2(10)	X	Region Identifier
PERIODID	NUMBER(3,0)	X	Trading interval
PAYMENTAMOUNT	NUMBER(18,8)		The NEM ancillary summary regional payment amount (\$)
LASTCHANGED	DATE		Last date and time record changed

26.7 Table: SET_FCAS_PAYMENT

26.7.1 SET_FCAS_PAYMENT

Name	SET_FCAS_PAYMENT
Comment	SET_FCAS_PAYMENT sets out the enabling payment details for frequency controlled Ancillary Services.

26.7.2 Description

SET_FCAS_PAYMENT data is confidential to the relevant participant.

Volume

Approximately 150,000 per week.

26.7.3 Notes

Name	Comment	Value
Visibility	Data in this table is:	Private

26.7.4 Primary Key Columns

Name
 DUID
 PERIODID
 SETTLEMENTDATE
 VERSIONNO

26.7.5 Index Columns

Name
 LASTCHANGED

26.7.6 Content

Name	Data Type	Mandatory	Comment
SETTLEMENTDATE	DATE	X	Settlement Date
VERSIONNO	NUMBER(3,0)	X	Settlement Run No
PARTICIPANTID	VARCHAR2(10)		Participant identifier
DUID	VARCHAR2(10)	X	Dispatchable unit identifier
REGIONID	VARCHAR2(10)		Region Identifier
PERIODID	NUMBER(3,0)	X	Trading interval
LOWER6SEC_PAYMENT	NUMBER(18,8)		Lower 6 Second Payment
RAISE6SEC_PAYMENT	NUMBER(18,8)		Raise 6 Second Payment
LOWER60SEC_PAYMENT	NUMBER(18,8)		Lower 60 Second Payment
RAISE60SEC_PAYMENT	NUMBER(18,8)		Raise 60 Second Payment
LOWER5MIN_PAYMENT	NUMBER(18,8)		Lower 5 Minute Payment
RAISE5MIN_PAYMENT	NUMBER(18,8)		Raise 5 Minute Payment
LOWERREG_PAYMENT	NUMBER(18,8)		Lower 5 Minute Regulation Payment
RAISEREG_PAYMENT	NUMBER(18,8)		Raise 5 Minute Regulation Payment
LASTCHANGED	DATE		Last date and time record changed

26.8 Table: SET_FCAS_RECOVERY

26.8.1 SET_FCAS_RECOVERY

Name	SET_FCAS_RECOVERY
Comment	SET_FCAS_RECOVERY shows reimbursements for the Frequency Control Ancillary Services (FCAS) to be recovered from participants. Beware of potential confusion with the table SETFCASRECOVERY, which reports reimbursements for Frequency Control Ancillary Services Compensation (now unused).

26.8.2 Description

SET_FCAS_RECOVERY data is confidential to the relevant participant.

Volume

Approximately 1, 500, 000 per week.

26.8.3 Notes

Name	Comment	Value
Visibility	Data in this table is:	Private

26.8.4 Primary Key Columns

- Name
- PARTICIPANTID
- PERIODID
- REGIONID
- SETTLEMENTDATE
- VERSIONNO

26.8.5 Index Columns

Name

LASTCHANGED

26.8.6 Content

Name	Data Type	Mandatory	Comment
SETTLEMENTDATE	DATE	X	Settlement Date
VERSIONNO	VARCHAR2(3)	X	Settlement Run No
PARTICIPANTID	VARCHAR2(10)	X	Participant identifier
REGIONID	VARCHAR2(10)	X	Region Identifier
PERIODID	NUMBER(3,0)	X	Trading interval
LOWER6SEC_RECOVERY	NUMBER(18,8)		Recovery amount for the Lower 6 Second service attributable to customer connection points
RAISE6SEC_RECOVERY	NUMBER(18,8)		Recovery amount for the Raise 6 Second service attributable to customer connection points
LOWER60SEC_RECOVERY	NUMBER(18,8)		Recovery amount for the Lower 60 Second service attributable to customer connection points
RAISE60SEC_RECOVERY	NUMBER(18,8)		Recovery amount for the Raise 60 Second service attributable to customer connection points
LOWER5MIN_RECOVERY	NUMBER(18,8)		Recovery amount for the Lower 5 Minute service attributable to customer connection points

RAISE5MIN_RECOVERY	NUMBER(18,8)		Recovery amount for the Raise 5 Minute service attributable to customer connection points
LOWERREG_RECOVERY	NUMBER(18,8)		Recovery amount for the Lower Regulation service attributable to customer connection points
RAISEREG_RECOVERY	NUMBER(18,8)		Recovery amount for the Raise Regulation Second service attributable to customer connection points
LASTCHANGED	DATE		Last date and time record changed
LOWER6SEC_RECOVERY_GEN	NUMBER(18,8)		Recovery amount for the Lower 6 Second service attributable to generator connection points
RAISE6SEC_RECOVERY_GEN	NUMBER(18,8)		Recovery amount for the Raise 6 Second service attributable to generator connection points
LOWER60SEC_RECOVERY_GEN	NUMBER(18,8)		Recovery amount for the Lower 60 Second service attributable to generator connection points
RAISE60SEC_RECOVERY_GEN	NUMBER(18,8)		Recovery amount for the Raise 60 Second service attributable to generator connection points
LOWER5MIN_RECOVERY_GEN	NUMBER(18,8)		Recovery amount for the Lower 5 Minute service attributable to generator connection points
RAISE5MIN_RECOVERY_GEN	NUMBER(18,8)		Recovery amount for the Raise 5 Minute service attributable to generator connection points
LOWERREG_RECOVERY_GEN	NUMBER(18,8)		Recovery amount for the Lower Regulation service attributable to

			generator connection points
RAISEREG_RECOVERY_GEN	NUMBER(18,8)		Recovery amount for the Raise Regulation Second service attributable to generator connection points

26.9 Table: SET_FCAS_REGULATION_TRK

26.9.1 SET_FCAS_REGULATION_TRK

Name	SET_FCAS_REGULATION_TRK
Comment	SET_FCAS_REGULATION_TRK shows FCAS Regulation Service Constraint tracking for Regional FCAS Regulation recovery

26.9.2 Description

SET_FCAS_REGULATION_TRK contains public data and is available to all participants.

Volume

Approximately 350,000 per week.

26.9.3 Notes

Name	Comment	Value
Visibility	Data in this table is:	Public

26.9.4 Primary Key Columns

Name

CONSTRAINTID

INTERVAL_DATETIME

SETTLEMENTDATE

VERSIONNO

26.9.5 Index Columns

Name

LASTCHANGED

26.9.6 Content

Name	Data Type	Mandatory	Comment
SETTLEMENTDATE	DATE	X	Settlement Date
VERSIONNO	NUMBER(3,0)	X	Settlement Run No
INTERVAL_DATETIME	DATE	X	Dispatch Interval Date Time
CONSTRAINTID	VARCHAR2(20)	X	Generic Constraint ID
CMPF	NUMBER(18,8)		Constraint Market Participant Factor
CRMPF	NUMBER(18,8)		Constraint Residual Market Participant Factor
RECOVERY_FACTOR_CMPF	NUMBER(18,8)		Recovery factor for CMPF based recovery
RECOVERY_FACTOR_CRMPF	NUMBER(18,8)		Recovery factor for CRMPF based recovery
LASTCHANGED	DATE		Last date and time record changed

26.10 Table: SET_MR_PAYMENT

26.10.1 SET_MR_PAYMENT

Name	SET_MR_PAYMENT
Comment	SET_MR_PAYMENT shows trading interval payments on a dispatchable unit basis for accepted MR capacity.

26.10.2 Description

SET_MR_PAYMENT data is confidential to the relevant participant.

Source

SET_MR_PAYMENT updates are ad hoc, being for MR events only.

Volume

24000 rows per year

26.10.3 Notes

Name	Comment	Value
Visibility	Data in this table is:	Private

26.10.4 Primary Key Columns

- Name
- DUID
- PERIODID
- REGIONID
- SETTLEMENTDATE
- VERSIONNO

26.10.5 Index Columns

Name

LASTCHANGED

26.10.6 Content

Name	Data Type	Mandatory	Comment
SETTLEMENTDATE	DATE	X	Settlement Date (Calendar)
VERSIONNO	NUMBER(3,0)	X	Settlement Run Number for this date
REGIONID	VARCHAR2(10)	X	Unique Region Identifier
PARTICIPANTID	VARCHAR2(10)		Unique Participant identifier
DUID	VARCHAR2(10)	X	Unique identifier for DUID / MNSP LinkID
PERIODID	NUMBER(3,0)	X	Calendar day Trading Interval number
MR_CAPACITY	NUMBER(16,6)		Accepted MR Capacity
UNCAPPED_PAYMENT	NUMBER(16,6)		Uncapped Trading Interval Payment
CAPPED_PAYMENT	NUMBER(16,6)		Capped Trading Interval Payment
LASTCHANGED	DATE		Date/Time record inserted/modified

26.11 Table: SET_MR_RECOVERY

26.11.1 SET_MR_RECOVERY

Name	SET_MR_RECOVERY
Comment	SET_MR_RECOVERY shows the trading interval recovery charges on a dispatchable unit basis for spot market income from dispatch of MR capacity.

26.11.2 Description

SET_MR_RECOVERY data is confidential to the relevant participant.

Source

SET_MR_RECOVERY updates are ad hoc, being for MR events only.

Volume

24000 rows per year

26.11.3 Notes

Name	Comment	Value
Visibility	Data in this table is:	Private

26.11.4 Primary Key Columns

- Name
- DUID
- PERIODID
- REGIONID
- SETTLEMENTDATE
- VERSIONNO

26.11.5 Index Columns

Name

LASTCHANGED

26.11.6 Content

Name	Data Type	Mandatory	Comment
SETTLEMENTDATE	DATE	X	Settlement Date (Calendar)
VERSIONNO	NUMBER(3,0)	X	Settlement Run Number for this date
REGIONID	VARCHAR2(10)	X	Unique Region Identifier
PARTICIPANTID	VARCHAR2(10)		Unique Participant identifier
DUID	VARCHAR2(10)	X	Unique identifier for DUID / MNSP LinkID
PERIODID	NUMBER(3,0)	X	Calendar day Trading Interval number
ARODEF	NUMBER(16,6)		Accepted Restriction Offer Dispatched Energy Factor
NTA	NUMBER(16,6)		The amount payable to AEMO for that accepted restriction offer and trading interval
LASTCHANGED	DATE		Date/Time record inserted/modified

26.12 Table: SET_NMAS_RECOVERY

26.12.1 SET_NMAS_RECOVERY

Name	SET_NMAS_RECOVERY
Comment	SET_NMAS_RECOVERY sets out the NSCAS recovery data for payments other than testing.

26.12.2 Notes

Name	Comment	Value
Visibility	Data in this table is:	Private

26.12.3 Primary Key Columns

Name

CONTRACTID

PARTICIPANTID

PAYMENTTYPE

PERIODID

REGIONID

SERVICE

SETTLEMENTDATE

VERSIONNO

26.12.4 Index Columns

Name

LASTCHANGED

26.12.5 Content

Name	Data Type	Mandatory	Comment
SETTLEMENTDATE	DATE	X	Settlement Date
VERSIONNO	NUMBER(3,0)	X	Settlement run number
PERIODID	NUMBER(3,0)	X	Half Hourly Interval
PARTICIPANTID	VARCHAR(20)	X	The Participant from whom the amount is recovered
SERVICE	VARCHAR(10)	X	The type of NSCAS service. Current value values are: - REACTIVE - LOADSHED
CONTRACTID	VARCHAR(10)	X	The NMAS Contract Id
PAYMENTTYPE	VARCHAR(20)	X	The type of payment being recovered. Valid values are: - AVAILABILITY - ENABLEMENT - COMPENSATION
REGIONID	VARCHAR(10)	X	The region from where the amount is recovered
RBF	NUMBER(18,8)		The Benefitting Factor for the RegionId
PAYMENT_AMOUNT	NUMBER(18,8)		The total Payment Amount to recover from all benefitting regions

PARTICIPANT_ENERGY	NUMBER(18,8)		The Participant energy in MWh for the period
REGION_ENERGY	NUMBER(18,8)		The RegionId energy in MWh for the period
RECOVERY_AMOUNT	NUMBER(18,8)		The Total recovery amount for the period for the PARTICIPANTID and REGIONID
LASTCHANGED	DATE		The Last Updated date and time
PARTICIPANT_GENERATION	NUMBER(18,8)		Participant Generator Energy in the benefitting region
REGION_GENERATION	NUMBER(18,8)		The generator energy in the benefitting region
RECOVERY_AMOUNT_CUSTOMER	NUMBER(18,8)		The recovery amount allocated to customers
RECOVERY_AMOUNT_GENERATOR	NUMBER(18,8)		The recovery amount allocated to generators

26.13 Table: SET_NMAS_RECOVERY_RBF

26.13.1 SET_NMAS_RECOVERY_RBF

Name	SET_NMAS_RECOVERY_RBF
Comment	SET_NMAS_RECOVERY_RBF publishes the RBF for NSCAS non testing payments on a half hourly basis.

26.13.2 Notes

Name	Comment	Value
Visibility	Data in this table is:	Public

26.13.3 Primary Key Columns

Name

CONTRACTID

PAYMENTTYPE

PERIODID

REGIONID

SERVICE

SETTLEMENTDATE

VERSIONNO

26.13.4 Index Columns

Name

LASTCHANGED

26.13.5 Content

Name	Data Type	Mandatory	Comment
SETTLEMENTDATE	DATE	X	Settlement Date
VERSIONNO	NUMBER(3,0)	X	Settlement run number
PERIODID	NUMBER(3,0)	X	Half Hourly Interval
SERVICE	VARCHAR(10)	X	The type of NSCAS service. Current value values are: - REACTIVE - LOADSHED
CONTRACTID	VARCHAR(10)	X	The NMAS Contract Id
PAYMENTTYPE	VARCHAR(20)	X	The type of payment being recovered. Valid values are: - AVAILABILITY - ENABLEMENT - COMPENSATION
REGIONID	VARCHAR(10)	X	The region from where the amount is recovered
RBF	NUMBER(18,8)		The Benefitting Factor for the RegionId
PAYMENT_AMOUNT	NUMBER(18,8)		The total Payment Amount to recover from all benefitting regions
RECOVERY_AMOUNT	NUMBER(18,8)		The Total recovery amount for the period for the REGIONID
LASTCHANGED	DATE		The Last Updated date and time

26.14 Table: SET_RUN_PARAMETER

26.14.1 SET_RUN_PARAMETER

Name	SET_RUN_PARAMETER
Comment	SET_RUN_PARAMETER shows the input parameters and value associated with each settlement run (e.g. Residual System Load Causer Pays Factor).

26.14.2 Description

Change History

19 August 2005 for 4.5.0:

Changed index name again to have suffix of _LCX

Note: primary key shows PK_ as prefix in Oracle SQL script, even though name of key has _PK as suffix - but cannot change since would not improve participant systems .

17 August 2005 for v4.5.0

Added tablespace (02) for recently added index, and gave index a better name

26.14.3 Notes

Name	Comment	Value
Visibility	Data in this table is:	Public

26.14.4 Primary Key Columns

Name

PARAMETERID

SETTLEMENTDATE

VERSIONNO

26.14.5 Index Columns

Name

LASTCHANGED

26.14.6 Content

Name	Data Type	Mandatory	Comment
SETTLEMENTDATE	DATE	X	Settlement Date (Calendar)
VERSIONNO	NUMBER(3)	X	Settlement Run Number for this date
PARAMETERID	VARCHAR2(20)	X	Parameter Identifier
NUMVALUE	NUMBER(18,8)		Settlement Run Amount for the Constant Identifier
LASTCHANGED	DATE		Last date the record changed

26.15 Table: SETAGCPAYMENT

26.15.1 SETAGCPAYMENT

Name	SETAGCPAYMENT
Comment	SETAGCPAYMENT sets out specific payment details for Automatic Generation Control (AGC) services by period.

26.15.2 Description

SETAGCPAYMENT data is confidential to the relevant participant

Source

SETAGCPAYMENT updates with each settlement run.

26.15.3 Notes

Name	Comment	Value
Visibility	Data in this table is:	Private

26.15.4 Primary Key Columns

Name

CONTRACTID

PARTICIPANTID

PERIODID

SETTLEMENTDATE

VERSIONNO

26.15.5 Index Columns

Name

LASTCHANGED

26.15.6 Index Columns

Name

PARTICIPANTID

26.15.7 Content

Name	Data Type	Mandatory	Comment
SETTLEMENTDATE	DATE	X	Calendar Settlement Date
VERSIONNO	NUMBER(3,0)	X	Settlement Run No.
PARTICIPANTID	VARCHAR2(10))	X	Unique participant identifier
CONTRACTID	VARCHAR2(10))	X	Contract Identifier
PERIODID	NUMBER(3,0)	X	Settlement Period Identifier
DUID	VARCHAR2(10))		Dispatchable Unit ID
REGIONID	VARCHAR2(10))		Region Identifier
TLF	NUMBER(7,5)		Transmission Loss Factor of Unit
EBP	NUMBER(15,5)		Eligible Bid Price
RRP	NUMBER(15,5)		Regional Reference Price
CLEAREDMW	NUMBER(15,5)		Cleared MW of Unit in Enabled Dispatch period

INITIALMW	NUMBER(15,5)		Initial MW of Unit in Enabled Dispatch period
ENABLINGPAYMENT	NUMBER(15,5)		Enabling Payment
CONTRACTVERSIONNO	NUMBER(3,0)		AS contract version no
OFFERDATE	DATE		Re-offer offer date
OFFERVERSIONNO	NUMBER(3,0)		Re-Offer Version No.
LASTCHANGED	DATE		Last date and time record changed

26.16 Table: SETAGCRECOVERY

26.16.1 SETAGCRECOVERY

Name	SETAGCRECOVERY
Comment	SETAGCRECOVERY shows reimbursements for Automatic Generation Control (AGC) Ancillary Services to be recovered from participants.

26.16.2 Description

SETAGCRECOVERY data is confidential to the relevant participant

Source

SETAGCRECOVERY updates with each settlement run.

26.16.3 Notes

Name	Comment	Value
Visibility	Data in this table is:	Private

26.16.4 Primary Key Columns

- Name
- PARTICIPANTID
- PERIODID
- REGIONID
- SETTLEMENTDATE
- VERSIONNO

26.16.5 Index Columns

- Name

LASTCHANGED

26.16.6 Content

Name	Data Type	Mandatory	Comment
SETTLEMENTDATE	DATE	X	Settlement Date
VERSIONNO	NUMBER(3,0)	X	Settlement Run No.
PARTICIPANTID	VARCHAR2(10)	X	Participant to pay recovery
CONTRACTID	VARCHAR2(10)		
PERIODID	NUMBER(3,0)	X	Trading Interval
REGIONID	VARCHAR2(10)	X	Region Identifier
ENABLINGPAYMENT	NUMBER(15,5)		Enabling Payment
PARTICIPANTDEMAND	NUMBER(15,5)		Participant Demand in Region
REGIONDEMAND	NUMBER(15,5)		Total Regional Demand
ENABLINGRECOVERY	NUMBER(15,5)		Enabling Recovery
LASTCHANGED	DATE		Last date and time record changed
ENABLINGRECOVERY_GEN	NUMBER(15,5)		Enabling Recovery for Generator
PARTICIPANTDEMAND_GEN	NUMBER(15,5)		Participant Demand in Region for Generator
REGIONDEMAND_GEN	NUMBER(15,5)		Total Regional Demand for Generator

26.17 Table: SETCPDATA

26.17.1 SETCPDATA

Name	SETCPDATA
Comment	SETCPDATA shows meter settlement data for each connection point. This is the key view for retailers to verify energy charges. A regional summary view is also provided. As the view has values for each connection point by period, for each meter data file, it is a very large view.

26.17.2 Description

The Connection point details (in SETCPDATA) are confidential to the participant and host retailer that the connection points relate to. By comparison, the regional data (SETCPDATAREGION) is publically available.

Source

SETCPDATA updates with each Settlement run.

26.17.3 Notes

Name	Comment	Value
Visibility	Data in this table is:	Private

26.17.4 Primary Key Columns

- Name
- MDA
- PARTICIPANTID
- PERIODID
- SETTLEMENTDATE
- TCPID
- VERSIONNO

26.17.5 Index Columns

Name

LASTCHANGED

26.17.6 Index Columns

Name

PARTICIPANTID

26.17.7 Content

Name	Data Type	Mandatory	Comment
SETTLEMENTDATE	DATE	X	Calendar Settlement Date
VERSIONNO	NUMBER(10,0)	X	Settlement run no
PERIODID	NUMBER(10,0)	X	Settlement Period identifier
PARTICIPANTID	VARCHAR2(10)	X	Unique participant identifier
TCPID	VARCHAR2(10)	X	Connection point identifier
REGIONID	VARCHAR2(10)		Region Identifier
IGENERGY	NUMBER(16,6)		Import Gross energy into the pool - MWh
XGENERGY	NUMBER(16,6)		Export Gross energy from the pool - MWh
INENERGY	NUMBER(16,6)		Import Nett energy into the pool -

			MWh
XNENERGY	NUMBER(16,6)		Export Nett energy from the pool - MWh
IPOWER	NUMBER(16,6)		Import reactive power
XPOWER	NUMBER(16,6)		Export reactive power
RRP	NUMBER(20,5)		Regional Reference Price
EEP	NUMBER(16,6)		Excess Energy Price
TLF	NUMBER(7,5)		Transmission Loss Factor
CPRRP	NUMBER(16,6)		Connection Point Price = RRP * TLF
CPEEP	NUMBER(16,6)		Connection Point Excess Energy Price = EEP * TLF
TA	NUMBER(16,6)		Export - Import of Net energy (MWh)
EP	NUMBER(16,6)		settlement amount in \$ for trading period
APC	NUMBER(16,6)		Not used
RESC	NUMBER(16,6)		Not used
RESP	NUMBER(16,6)		Not used
METERRUNNO	NUMBER(10,0)		Meter Run Number = version number of the meter file
LASTCHANGED	DATE		Last date and time record changed
HOSTDISTRIBUTOR	VARCHAR2(10)		Not used
MDA	VARCHAR2(10)	X	Metering Data Agent

26.18 Table: SETCPDATAREGION

26.18.1 SETCPDATAREGION

Name	SETCPDATAREGION
Comment	SETCPDATAREGION sets out summary meter settlement data for each region.

26.18.2 Description

SETCPDATAREGION data is public, so is available to all participants.

Source

SETCPDATAREGION is a summary based on grouping on SETCPDATA and is updated with each settlement run.

26.18.3 Notes

Name	Comment	Value
Visibility	Data in this table is:	Public

26.18.4 Primary Key Columns

- Name
- PERIODID
- REGIONID
- SETTLEMENTDATE
- VERSIONNO

26.18.5 Index Columns

- Name
- LASTCHANGED

26.18.6 Content

Name	Data Type	Mandatory	Comment
SETTLEMENTDATE	DATE	X	Calendar Settlement Date
VERSIONNO	NUMBER(22,10)	X	Settlement run no
PERIODID	NUMBER(22,10)	X	Settlement Period identifier
REGIONID	VARCHAR2(10)	X	Region Identifier
SUMIGENERGY	NUMBER(27,5)		Import Gross energy into the pool - MWh
SUMXGENERGY	NUMBER(27,5)		Export Gross energy from the pool - MWh
SUMINENERGY	NUMBER(27,5)		Import Nett energy into the pool - MWh
SUMXNENERGY	NUMBER(27,5)		Export Nett energy from the pool - MWh
SUMIPOWER	NUMBER(22,0)		Not used
SUMXPOWER	NUMBER(22,0)		Not used
LASTCHANGED	DATE		current system date, to enable automatic replication
SUMEP	NUMBER(15,5)		Sum of energy price across the region

26.19 Table: SETFCASCOMP

26.19.1 SETFCASCOMP

Name SETFCASCOMP

Comment SETFCASCOMP shows the compensation details for Frequency Controlled Ancillary Services (FCAS). These compensation values are calculated by a separate "what if" run of the LP Solver and entered as an unconstrained MW value into settlements.

26.19.2 Description

SETFCASCOMP data is confidential to the relevant participant

Source

SETFCASCOMP updates with each Settlement run, if required.

26.19.3 Notes

Name	Comment	Value
Visibility	Data in this table is:	Private

26.19.4 Primary Key Columns

Name

DUID

PARTICIPANTID

PERIODID

SETTLEMENTDATE

VERSIONNO

26.19.5 Index Columns

Name

LASTCHANGED

26.19.6 Content

Name	Data Type	Mandatory	Comment
SETTLEMENTDATE	DATE	X	Settlement Date
VERSIONNO	NUMBER(3,0)	X	Settlement Run No.
PARTICIPANTID	VARCHAR2(10)	X	Participant Identifier
DUID	VARCHAR2(10)	X	Dispatchable Unit ID
REGIONID	VARCHAR2(10)		Region Identifier
PERIODID	NUMBER(3,0)	X	Period Identifier
CCPRICE	NUMBER(15,5)		Compensation Cap
CLEAREDMW	NUMBER(15,5)		Cleared MW of Unit in First Dispatch period in Trading Interval
UNCONSTRAINEDMW	NUMBER(15,5)		Initial MW of Unit in First Dispatch period in Trading Interval
EBP	NUMBER(15,5)		Eligible Bid Price
TLF	NUMBER(7,5)		Transmission Loss Factor of Unit
RRP	NUMBER(15,5)		Regional Reference Price
EXCESSGEN	NUMBER(15,5)		Excess Generation Payment in trading interval

FCASCOMP	NUMBER(15,5)		Frequency Control AS Compensation payment to Generator
LASTCHANGED	DATE		

26.20 Table: SETFCASREGIONRECOVERY

26.20.1 SETFCASREGIONRECOVERY

Name	SETFCASREGIONRECOVERY
Comment	SETFCASREGIONRECOVERY shows FCAS Regional Recovery Data against each Trading Interval.

26.20.2 Description

SETFCASREGIONRECOVERY contains public data and is available to all participants.

Source

SETFCASREGIONRECOVERY updates with each settlements run.

Volume

Approximately 10,000 rows per day

26.20.3 Notes

Name	Comment	Value
Visibility	Data in this table is:	Public

26.20.4 Primary Key Columns

- Name
- BIDTYPE
- PERIODID
- REGIONID
- SETTLEMENTDATE
- VERSIONNO

26.20.5 Index Columns

Name

LASTCHANGED

26.20.6 Content

Name	Data Type	Mandatory	Comment
SETTLEMENTDATE	DATE	X	Settlement Date of trading interval
VERSIONNO	NUMBER(3,0)	X	Settlement run no
BIDTYPE	VARCHAR2(10)	X	FCAS Service Type
REGIONID	VARCHAR2(10)	X	RegionID
PERIODID	NUMBER(3,0)	X	Trading interval periodid (01 to 48)
GENERATORREGIONENERGY	NUMBER(16,6)		Generator Regional Energy Amount
CUSTOMERREGIONENERGY	NUMBER(16,6)		Customer Region Energy Amount
REGIONRECOVERY	NUMBER(18,8)		The NEM Regional Recovery Amount for FCAS
LASTCHANGED	DATE		Last Date record changed

26.21 Table: SETGENDATA

26.21.1 SETGENDATA

Name	SETGENDATA
Comment	SETGENDATA shows meter settlement data for each generation meter point. A regional summary is also provided.

26.21.2 Description

SETGENDATA shows generator meter details, and SETGENDATA data is confidential to the participant. By comparison, the regional summary (SETGENDATAREGION) is public data.

Source

SETGENDATA updates with each Settlement run.

26.21.3 Notes

Name	Comment	Value
Visibility	Data in this table is:	Private

26.21.4 Primary Key Columns

- Name
- DUID
- GENSETID
- PERIODID
- REGIONID
- SETTLEMENTDATE
- STATIONID
- VERSIONNO

26.21.5 Index Columns

Name

LASTCHANGED

26.21.6 Index Columns

Name

PARTICIPANTID

26.21.7 Content

Name	Data Type	Mandatory	Comment
SETTLEMENTDATE	DATE	X	Calendar Settlement Date
VERSIONNO	NUMBER(10,0)	X	Settlement run no
PERIODID	NUMBER(10,0)	X	Settlement Period identifier
PARTICIPANTID	VARCHAR2(10)		Unique participant identifier
STATIONID	VARCHAR2(10)	X	Station Identifier
DUID	VARCHAR2(10)	X	Dispatchable Unit identifier
GENSETID	VARCHAR2(10)	X	Physical unit identifier
REGIONID	VARCHAR2(10)	X	Region Identifier
GENERGY	NUMBER(16,6)		Generated energy

AENERGY	NUMBER(16,6)		Purchased Energy
GPOWER	NUMBER(16,6)		Not used
APOWER	NUMBER(16,6)		Not used
RRP	NUMBER(20,5)		Regional Reference Price
EEP	NUMBER(16,6)		Excess Energy Price
TLF	NUMBER(7,5)		Transmission Loss Factor
CPRRP	NUMBER(16,6)		Connection Point Price = RRP * TLF
CPEEP	NUMBER(16,6)		Connection Point Excess Energy Price = EEP * TLF
NETENERGY	NUMBER(16,6)		Net energy (MWh)
ENERGYCOST	NUMBER(16,6)		Cost of net energy \$
EXCESSENERGYCOST	NUMBER(16,6)		Cost of excess energy \$
APC	NUMBER(16,6)		Administered Price Compensation
RESC	NUMBER(16,6)		Not used
RESP	NUMBER(16,6)		Not used
LASTCHANGED	DATE		Last date and time record changed
EXPENERGY	NUMBER(15,6)		Export Energy (Generator Purchases) (MWh)
EXPENERGYCOST	NUMBER(15,6)		Export Energy Cost (\$)
METERRUNNO	NUMBER(6,0)		Identifier of the meter run used in this settlement calculation
MDA	VARCHAR2(10)		Metering Data Agent
SECONDARY_TLF	NUMBER(7,5)		Secondary Transmission Loss

			Factor
--	--	--	--------

26.22 Table: SETGENDATAREGION

26.22.1 SETGENDATAREGION

Name	SETGENDATAREGION
Comment	SETGENDATAREGION sets out summary settlement data for generation within the specified region.

26.22.2 Description

SETGENDATAREGION shows the regional summary. SETGENDATAREGION is public data.

Source

SETGENDATAREGION updates with each Settlement run.

26.22.3 Notes

Name	Comment	Value
Visibility	Data in this table is:	Public

26.22.4 Primary Key Columns

Name

PERIODID

REGIONID

SETTLEMENTDATE

VERSIONNO

26.22.5 Index Columns

Name

LASTCHANGED

26.22.6 Content

Name	Data Type	Mandatory	Comment
SETTLEMENTDATE	DATE	X	Calendar Settlement Date
VERSIONNO	NUMBER(22,10)	X	Settlement run no
PERIODID	NUMBER(22,10)	X	Settlement Period identifier
REGIONID	VARCHAR2(10)	X	Region Identifier
GENERGY	NUMBER(22,0)		Generated energy - Not used in MMS Data Model
AENERGY	NUMBER(22,0)		Purchased Energy - Not used in MMS Data Model
GPOWER	NUMBER(22,0)		Not used in MMS Data Model
APOWER	NUMBER(22,0)		Not used in MMS Data Model
NETENERGY	NUMBER(27,5)		Net energy MW/hours
ENERGYCOST	NUMBER(27,5)		Cost of net energy \$
EXCESSENERGYCOST	NUMBER(27,5)		Cost of excess energy \$
EXPENERGY	NUMBER(27,6)		Export Energy (Generator Purchases)
EXPENERGYCOST	NUMBER(27,6)		Export Energy Cost
LASTCHANGED	DATE		current system date, to enable automatic replication

26.23 Table: SETINTERVENTION

26.23.1 SETINTERVENTION

Name	SETINTERVENTION
Comment	SETINTERVENTION shows intervention settlement payment details by unit.

26.23.2 Description

SETINTERVENTION became unused when Ancillary Services Review was implemented. For more details, see Change Notice 126.

SETINTERVENTION data is confidential to each participant.

Source

SETINTERVENTION is unused; was updating when intervention occurred in a billing run.

26.23.3 Notes

Name	Comment	Value
Visibility	Data in this table is:	Private

26.23.4 Primary Key Columns

Name

DUID

PERIODID

SETTLEMENTDATE

VERSIONNO

26.23.5 Index Columns

Name

LASTCHANGED

26.23.6 Content

Name	Data Type	Mandatory	Comment
SETTLEMENTDATE	DATE	X	Calendar Settlement Date
VERSIONNO	NUMBER(3,0)	X	Settlement Run No.
PERIODID	NUMBER(3,0)	X	Settlement Period identifier
CONTRACTID	VARCHAR2(10)		Intervention Contract Identifier
CONTRACTVERSION	NUMBER(3,0)		Intervention Contract Version
PARTICIPANTID	VARCHAR2(10)		Unique participant identifier
REGIONID	VARCHAR2(10)		Region Identifier
DUID	VARCHAR2(10)	X	Dispatchable Unit ID
RCF	CHAR(1)		Regional Recovery Flag
INTERVENTIONPAYMENT	NUMBER(12,5)		Payment to Generator for Intervention
LASTCHANGED	DATE		Last date and time record changed

26.24 Table: SETINTERVENTIONRECOVERY

26.24.1 SETINTERVENTIONRECOVERY

Name	SETINTERVENTIONRECOVERY
Comment	SETINTERVENTIONRECOVERY shows intervention recovery details by participant.

26.24.2 Description

Status

SETINTERVENTIONRECOVERY became unused when Ancillary Services Review was implemented. For more details, see Change Notice 126.

Confidential to participant

Source

Unused; was updating when intervention occurred in a billing run.

26.24.3 Notes

Name	Comment	Value
Visibility	Data in this table is:	Private

26.24.4 Primary Key Columns

Name

CONTRACTID

PARTICIPANTID

PERIODID

SETTLEMENTDATE

VERSIONNO

26.24.5 Index Columns

Name

LASTCHANGED

26.24.6 Content

Name	Data Type	Mandatory	Comment
SETTLEMENTDATE	DATE	X	Calendar Settlement Date
VERSIONNO	NUMBER(3,0)	X	Settlement Run No.
PERIODID	NUMBER(3,0)	X	Settlement Period identifier
CONTRACTID	VARCHAR2(10)	X	Intervention Contract Identifier
RCF	CHAR(1)		Regional Recovery Flag
PARTICIPANTID	VARCHAR2(10)	X	Unique participant identifier
PARTICIPANTDEMAND	NUMBER(12,5)		Demand of Participant in Region/Market
TOTALDEMAND	NUMBER(12,5)		Total Demand of Region/Market
INTERVENTIONPAYMENT	NUMBER(12,5)		Payment to Generator for Intervention
INTERVENTIONAMOUNT	NUMBER(12,5)		Retailer Payment to Pool for Intervention
LASTCHANGED	DATE		Last date and time record changed
REGIONID	VARCHAR2(10)		Region Identifier

26.25 Table: SETINTRAREGIONRESIDUES

26.25.1 SETINTRAREGIONRESIDUES

Name SETINTRAREGIONRESIDUES

Comment

26.25.2 Description

SETINTRAREGIONRESIDUES data is public to all participants.

Source

SETINTRAREGIONRESIDUES updates with each settlement run.

Note

The relationship between the data columns for each key is expressed in the following formula:
 $EP + EC + (EXP * RRP) = IRSS$

26.25.3 Notes

Name	Comment	Value
Visibility	Data in this table is:	Public

26.25.4 Primary Key Columns

- Name
- PERIODID
- REGIONID
- RUNNO
- SETTLEMENTDATE

26.25.5 Index Columns

- Name
- LASTCHANGED

26.25.6 Content

Name	Data Type	Mandatory	Comment
SETTLEMENTDATE	DATE	X	Settlement Date
RUNNO	NUMBER(3)	X	Settlement run number
PERIODID	NUMBER(3)	X	Settlement period in the day (1..48)
REGIONID	VARCHAR2(10)	X	Region Identifier
EP	NUMBER(15,5)		Energy payments to generators
EC	NUMBER(15,5)		Energy purchased by customers
RRP	NUMBER(15,5)		Regional price
EXP	NUMBER(15,5)		Net import in MWh into the region calculated at the regional reference node (export is negative)
IRSS	NUMBER(15,5)		Intra-regional surplus (a negative sign indicates surplus, and a positive sign indicates a deficiency)
LASTCHANGED	DATE		Last date and time record changed

26.26 Table: SETIRAUCSURPLUS

26.26.1 SETIRAUCSURPLUS

Name	SETIRAUCSURPLUS
Comment	This view supports the Settlements Residue Auction, by holding the NSP participant allocations of IRSurplus arising as a result of the unsold units for a quarter.

26.26.2 Description

SETIRAUCSURPLUS data is confidential to the relevant participant.

Source

SETIRAUCSURPLUS updates with each settlement run.

Volume

SETIRAUCSURPLUS contains a maximum of 10 million records per year.

26.26.3 Notes

Name	Comment	Value
Visibility	Data in this table is:	Private

26.26.4 Primary Key Columns

- Name
- CONTRACTID
- FROMREGIONID
- INTERCONNECTORID
- PARTICIPANTID
- PERIODID
- SETTLEMENTDATE

SETTLEMENTRUNNO

26.26.5 Index Columns

Name

LASTCHANGED

26.26.6 Content

Name	Data Type	Mandatory	Comment
SETTLEMENTDATE	DATE	X	Calendar Settlement Date
SETTLEMENTRUNNO	NUMBER(3,0)	X	Settlement run number
CONTRACTID	VARCHAR2(10)	X	SRA Contract unique identifier
PERIODID	NUMBER(2,0)	X	Settlement Period in day (1..48)
PARTICIPANTID	VARCHAR2(10)	X	Unique participant identifier
INTERCONNECTORID	VARCHAR2(10)	X	Contracted Interconnector identifier
FROMREGIONID	VARCHAR2(10)	X	Nominated source region for Interconnector
TOTALSURPLUS	NUMBER(15,5)		Total value of surplus before allocation
CONTRACTALLOCATION	NUMBER(8,5)		Percentage allocated to participant
SURPLUSVALUE	NUMBER(15,5)		Amount NSP is paid for Inter/intra-Regional surplus energy produced
LASTCHANGED	DATE		Date and time this record was last

			modified
CSP_DEROGATION_AMOUNT	NUMBER(18,8)		The CSP derogation amount applied as an adjustment to SRA
UNADJUSTED_IRSR	NUMBER(18,8)		The SRA amount unadjusted by CSP

26.27 Table: SETIRFMRECOVERY

26.27.1 SETIRFMRECOVERY

Name	SETIRFMRECOVERY
Comment	SETIRFMRECOVERY sets out reimbursements for Industrial Relations Force Majeure to be recovered from participants.

26.27.2 Description

SETIRFMRECOVERY data is confidential to the relevant participant.

Source

SETIRFMRECOVERY updates with each settlement run.

26.27.3 Notes

Name	Comment	Value
Visibility	Data in this table is:	Private

26.27.4 Primary Key Columns

Name

IRFMID

PARTICIPANTID

PERIODID

SETTLEMENTDATE

VERSIONNO

26.27.5 Index Columns

Name

LASTCHANGED

26.27.6 Content

Name	Data Type	Mandatory	Comment
SETTLEMENTDATE	DATE	X	Settlement date
VERSIONNO	NUMBER(3,0)	X	Version number
PERIODID	NUMBER(3,0)	X	Settlement period ID
IRFMID	VARCHAR2(10)	X	Industrial Relations Forced Majeure event number
IRMFVERSION	NUMBER(3,0)		Industrial Relations Forced Majeure event number
PARTICIPANTID	VARCHAR2(10)	X	Participant unique identifier
PARTICIPANTDEMAND	NUMBER(12,5)		Participant demand
TOTALTCD	NUMBER(12,5)		Total non franchised load in Victoria.
TOTALTFD	NUMBER(12,5)		Total franchised load in Victoria.
IRFMAMOUNT	NUMBER(12,5)		Industrial Relations Forced Majeure event amount in \$.
IRFMPAYMENT	NUMBER(12,5)		Industrial Relations Forced Majeure payment amount in \$.
LASTCHANGED	DATE		Last date and time record changed

26.28 Table: SETIRNSPSURPLUS

26.28.1 SETIRNSPSURPLUS

Name	SETIRNSPSURPLUS
Comment	This view supports the Settlements Residue Auction, by showing the TNSP participant allocations of Interconnector Residue (IR) Surplus (i.e. derogated amounts) arising as a result of the sold units for a quarter.

26.28.2 Description

SETIRNSPSURPLUS data is confidential to the relevant participant.

Source

SETIRNSPSURPLUS updates with each settlement run.

Volume

SETIRNSPSURPLUS contains a maximum of 10 million records per year.

26.28.3 Notes

Name	Comment	Value
Visibility	Data in this table is:	Private

26.28.4 Primary Key Columns

- Name
- CONTRACTID
- FROMREGIONID
- INTERCONNECTORID
- PARTICIPANTID
- PERIODID

SETTLEMENTDATE

SETTLEMENTRUNNO

26.28.5 Index Columns

Name

LASTCHANGED

26.28.6 Content

Name	Data Type	Mandatory	Comment
SETTLEMENTDATE	DATE	X	Settlement date
SETTLEMENTRUNNO	NUMBER(3,0)	X	Settlement run number
CONTRACTID	VARCHAR2(10)	X	SRA Contract unique identifier
PERIODID	NUMBER(2,0)	X	Settlement period in day (1..48)
PARTICIPANTID	VARCHAR2(10)	X	Participant unique identifier
INTERCONNECTORID	VARCHAR2(10)	X	Identifier of Contracted Interconnector
FROMREGIONID	VARCHAR2(10)	X	Nominated source region for Interconnector
TOTALSURPLUS	NUMBER(15,5)		Total value of surplus
CONTRACTALLOCATION	NUMBER(8,5)		Percentage of total surplus allocated to participant
SURPLUSVALUE	NUMBER(15,5)		Amount NSP is paid for Inter/intra-Regional surplus energy produced

			by the participant
LASTCHANGED	DATE		Date and time this record was last modified
CSP_DEROGATION_AMOUNT	NUMBER(18,8)		The CSP derogation amount applied as an adjustment to SRA
UNADJUSTED_IRSR	NUMBER(18,8)		The SRA amount unadjusted by CSP

26.29 Table: SETIRPARTSURPLUS

26.29.1 SETIRPARTSURPLUS

Name	SETIRPARTSURPLUS
Comment	This view supports the Settlements Residue Auction, holding the participant allocations of IRSurplus.

26.29.2 Description

SETIRPARTSURPLUS data is confidential to each participant.

Source

SETIRPARTSURPLUS updates with each settlement run.

Volume

SETIRPARTSURPLUS contains a maximum of 20 million records per year.

26.29.3 Notes

Name	Comment	Value
Visibility	Data in this table is:	Private

26.29.4 Primary Key Columns

- Name
- CONTRACTID
- FROMREGIONID
- INTERCONNECTORID
- PARTICIPANTID
- PERIODID
- SETTLEMENTDATE

SETTLEMENTRUNNO

26.29.5 Index Columns

Name

LASTCHANGED

26.29.6 Content

Name	Data Type	Mandatory	Comment
SETTLEMENTDATE	DATE	X	Settlement date
SETTLEMENTRUNNO	NUMBER(3,0)	X	Settlement run number
CONTRACTID	VARCHAR2(10)	X	Ancillary Service Contract
PERIODID	NUMBER(2,0)	X	Settlement period in the day (1..48)
PARTICIPANTID	VARCHAR2(10)	X	Participant unique identifier
INTERCONNECTORID	VARCHAR2(10)	X	Identifier of the Contracted Interconnector
FROMREGIONID	VARCHAR2(10)	X	Nominated source region for Interconnector
TOTALSURPLUS	NUMBER(15,5)		Total value of surplus before allocation
CONTRACTALLOCATION	NUMBER(8,5)		Allocated percentage to participant
SURPLUSVALUE	NUMBER(15,5)		Amount NSP is paid for Inter/intra-Regional surplus energy produced
LASTCHANGED	DATE		Date and time this record was last

			updated
CSP_DEROGATION_AMOUNT	NUMBER(18,8)		The CSP derogation amount applied as an adjustment to SRA
UNADJUSTED_IRSR	NUMBER(18,8)		The SRA amount unadjusted by CSP

26.30 Table: SETIRSURPLUS

26.30.1 SETIRSURPLUS

Name	SETIRSURPLUS
Comment	SETIRSURPLUS records the interregional residue calculation for each interconnector and each side of the interconnector.

26.30.2 Description

SETIRSURPLUS data is public, so is available to all participants.

Source

SETIRSURPLUS updates once a day at 8am.

Note

MWFLOW and LOSSFACTOR are now both calculated as MWh (energy) values for the half hour, and not MW (average demand) values. By way of clarification, the MWFLOW value is derived from half-hour revenue class metering, adjusted by a fixed fraction of the LOSSFACTOR value. The LOSSFACTOR value is taken to be exactly half of the MWLOSSES value in the TRADINGINTERCONNECT table.

The METEREDMWFLOW field in the TRADINGINTERCONNECT table contains averaged SCADA metering demand values available in “real time”, whereas the MWFLOW field in the SETIRSURPLUS table contains settlement energy metering values available only after a settlement run is posted.

26.30.3 Notes

Name	Comment	Value
Visibility	Data in this table is:	Public

26.30.4 Primary Key Columns

- Name
- INTERCONNECTORID
- PERIODID
- REGIONID

SETTLEMENTDATE

SETTLEMENTRUNNO

26.30.5 Index Columns

Name

LASTCHANGED

26.30.6 Content

Name	Data Type	Mandatory	Comment
SETTLEMENTDATE	DATE	X	Settlement date
SETTLEMENTRUNNO	NUMBER(3,0)	X	Settlement run number
PERIODID	NUMBER(3,0)	X	Trading interval
INTERCONNECTORID	VARCHAR2(10)	X	Interconnector
REGIONID	VARCHAR2(10)	X	Side of interconnector
MWFLOW	NUMBER(15,6)		Net flow at the regional node (MWh), including losses
LOSSFACTOR	NUMBER(15,5)		MW losses along interconnector NOTE: This is not a loss factor, but a loss figure expressed in MWH
SURPLUSVALUE	NUMBER(15,5)		Amount of surplus in \$
LASTCHANGED	DATE		Last date and time record changed
CSP_DEROGATION_AMOUNT	NUMBER(18,8)		The CSP derogation amount applied as an adjustment to SRA

UNADJUSTED_IRSR	NUMBER(18,8)		The SRA amount unadjusted by CSP
-----------------	--------------	--	----------------------------------

26.31 Table: SETLSHEDPAYMENT

26.31.1 SETLSHEDPAYMENT

Name	SETLSHEDPAYMENT
Comment	SETLSHEDPAYMENT shows specific payment details for load shed services by period.

26.31.2 Description

SETLSHEDPAYMENT data is confidential to the relevant participant.

Source

SETLSHEDPAYMENT updates with each settlement run.

26.31.3 Notes

Name	Comment	Value
Visibility	Data in this table is:	Private

26.31.4 Primary Key Columns

- Name
- CONTRACTID
- PARTICIPANTID
- PERIODID
- SETTLEMENTDATE
- VERSIONNO

26.31.5 Index Columns

- Name

LASTCHANGED

26.31.6 Index Columns

Name

PARTICIPANTID

26.31.7 Content

Name	Data Type	Mandatory	Comment
SETTLEMENTDATE	DATE	X	Settlement Date
VERSIONNO	NUMBER(3,0)	X	Settlement Run No.
PARTICIPANTID	VARCHAR2(10)	X	Participant Identifier
CONTRACTID	VARCHAR2(10)	X	AS Contract Identifier
PERIODID	NUMBER(3,0)	X	Trading Interval
DUID	VARCHAR2(10)		Dispatchable Unit Identifier
REGIONID	VARCHAR2(10)		Region Identifier
TLF	NUMBER(7,5)		Transmission Loss Factor
RRP	NUMBER(15,5)		Regional Reference Price
LSEPRICE	NUMBER(15,5)		Load Shed Enabling Price
MCPPRICE	NUMBER(15,5)		Minimum Compensation Price
LSCR	NUMBER(4,0)		Load Shed Control Range

LSEPAYMENT	NUMBER(15,5)		Load Shed Enabling Payment
CCPAYMENT	NUMBER(15,5)		Compensation Payment
CONSTRAINEDMW	NUMBER(15,5)		Cleared MW of unit at time of load shed usage
UNCONSTRAINEDMW	NUMBER(15,5)		Unconstrained MW of unit at time of load shed usage
ALS	NUMBER(15,5)		Amount of load shed
INITIALDEMAND	NUMBER(15,5)		Initial demand of unit at time of load shed usage
FINALDEMAND	NUMBER(15,5)		Final demand of unit at time of load shed usage
CONTRACTVERSIONNO	NUMBER(3,0)		AS Contract Version No.
OFFERDATE	DATE		Re-offer offer date
OFFERVERSIONNO	NUMBER(3,0)		Re-Offer Version No.
LASTCHANGED	DATE		Last date and time record changed
AVAILABILITYPAYMENT	NUMBER(16,6)		Payment amount for the Load Shed Availability service

26.32 Table: SETLSHEDRECOVERY

26.32.1 SETLSHEDRECOVERY

Name	SETLSHEDRECOVERY
Comment	SETLSHEDRECOVERY shows reimbursements for Load shed Ancillary Services to be recovered from participants. (Data no longer created for Settlement Days from 01/07/2012)

26.32.2 Description

SETLSHEDRECOVERY data is confidential to the relevant participant.

Source

SETLSHEDRECOVERY updates with each settlement run.

Note

Only the payment fields (LSEPAYMENT and CCPAYMENT) are on a regional basis. All other demand and recovery fields are on NEM basis rather than a regional basis.

26.32.3 Notes

Name	Comment	Value
Visibility	Data in this table is:	Private

26.32.4 Primary Key Columns

Name

PARTICIPANTID

PERIODID

REGIONID

SETTLEMENTDATE

VERSIONNO

26.32.5 Index Columns

Name

LASTCHANGED

26.32.6 Content

Name	Data Type	Mandatory	Comment
SETTLEMENTDATE	DATE	X	Settlement Date
VERSIONNO	NUMBER(3,0)	X	Settlement Run No.
PARTICIPANTID	VARCHAR2(10)	X	Participant to pay recovery
CONTRACTID	VARCHAR2(10)		Contract Identifier for reserve, intervention, settlement and ancillary service contracts. Contracts are coded by type and unit.
PERIODID	NUMBER(3,0)	X	Trading Interval
REGIONID	VARCHAR2(10)	X	Region Identifier
LSEPAYMENT	NUMBER(15,5)		Load Shed Enabling Payment
CCPAYMENT	NUMBER(15,5)		Compensation Payment
PARTICIPANTDEMAND	NUMBER(15,5)		Total Participant NEM Demand
REGIONDEMAND	NUMBER(15,5)		Total NEM Demand
LSERECOVERY	NUMBER(15,5)		Load Shed Enabling Recovery
CCRECOVERY	NUMBER(15,5)		Compensation Recovery
LASTCHANGED	DATE		Last date and time record changed

LSERECOVERY_GEN	NUMBER(15,5)		Load Shed Enabling Recovery for Generator
CCRECOVERY_GEN	NUMBER(15,5)		Compensation Recovery for Generator
PARTICIPANTDEMAND_GEN	NUMBER(15,5)		Total Participant NEM Demand for Generator
REGIONDEMAND_GEN	NUMBER(15,5)		Total NEM Demand for Generator
AVAILABILITYRECOVERY	NUMBER(16,6)		Recovery amount for the Load Shed Availability service attributable to customer connection points
AVAILABILITYRECOVERY_GEN	NUMBER(16,6)		Recovery amount for the Load Shed Availability service attributable to generator connection points

26.33 Table: SETLULOADRECOVERY

26.33.1 SETLULOADRECOVERY

Name	SETLULOADRECOVERY
Comment	SETLULOADRECOVERY shows reimbursements for rapid-unit-load Ancillary Services to be recovered from participants.

26.33.2 Description

SETLULOADRECOVERY became unused when Ancillary Services Review was implemented. For more details, see Change Notice 126.

SETLULOADRECOVERY data is confidential to each participant.

Source

SETLULOADRECOVERY is unused; was updated with each settlement run.

26.33.3 Notes

Name	Comment	Value
Visibility	Data in this table is:	Private

26.33.4 Primary Key Columns

Name

PARTICIPANTID

PERIODID

REGIONID

SETTLEMENTDATE

VERSIONNO

26.33.5 Index Columns

Name

LASTCHANGED

26.33.6 Content

Name	Data Type	Mandatory	Comment
SETTLEMENTDATE	DATE	X	Settlement Date
VERSIONNO	NUMBER(3,0)	X	Settlement Run No.
PARTICIPANTID	VARCHAR2(10)	X	Participant to pay recovery
CONTRACTID	VARCHAR2(10)		AS Contract ID
PERIODID	NUMBER(3,0)	X	Trading Interval
REGIONID	VARCHAR2(10)	X	Region Identifier
ENABLINGPAYMENT	NUMBER(15,5)		Enabling Payment
USAGEPAYMENT	NUMBER(15,5)		Usage Payment
COMPENSATIONPAYMENT	NUMBER(15,5)		Compensation Payment
PARTICIPANTDEMAND	NUMBER(15,5)		Participant Demand in Region
REGIONDEMAND	NUMBER(15,5)		Total Regional Demand
ENABLINGRECOVERY	NUMBER(15,5)		Enabling Recovery
USAGERECOVERY	NUMBER(15,5)		Usage Recovery
COMPENSATIONRECOVERY	NUMBER(15,5)		Compensation Recovery

LASTCHANGED	DATE		Last date and time record changed
ENABLINGRECOVERY_GEN	NUMBER(15,5)		Enabling Recovery for Generator
USAGERECOVERY_GEN	NUMBER(15,5)		Usage Recovery for Generator
COMPENSATIONRECOVER Y_GEN	NUMBER(15,5)		Compensation Recovery for Generator
PARTICIPANTDEMAND_GE N	NUMBER(15,5)		Participant Demand in Region for Generator
REGIONDEMAND_GEN	NUMBER(15,5)		Total Regional Demand for Generator

26.34 Table: SETLUNLOADPAYMENT

26.34.1 SETLUNLOADPAYMENT

Name	SETLUNLOADPAYMENT
Comment	SETLUNLOADPAYMENT shows specific payment details for rapid unit unload service.

26.34.2 Description

SETLUNLOADPAYMENT data is confidential to the relevant participant.

Source

SETLUNLOADPAYMENT updates with each settlement run.

26.34.3 Notes

Name	Comment	Value
Visibility	Data in this table is:	Private

26.34.4 Primary Key Columns

Name

CONTRACTID

PARTICIPANTID

PERIODID

SETTLEMENTDATE

VERSIONNO

26.34.5 Index Columns

Name

LASTCHANGED

26.34.6 Index Columns

Name

PARTICIPANTID

26.34.7 Content

Name	Data Type	Mandatory	Comment
SETTLEMENTDATE	DATE	X	Settlement date
VERSIONNO	NUMBER(3,0)	X	Settlement run no
PARTICIPANTID	VARCHAR2(10)	X	Unique participant identifier
CONTRACTID	VARCHAR2(10)	X	Ancillary Services contract identifier
PERIODID	NUMBER(3,0)	X	Region Identifier
DUID	VARCHAR2(10)		Dispatchable unit identifier
REGIONID	VARCHAR2(10)		Region identifier
TLF	NUMBER(7,5)		Transmission Loss Factor
EBP	NUMBER(15,5)		Eligible bid price
RRP	NUMBER(15,5)		Regional Reference Price
ENABLINGPRICE	NUMBER(15,5)		Enabling price
USAGEPRICE	NUMBER(15,5)		Usage Price

CCPRICE	NUMBER(15,5)		Compensation cap
CLEAREDMW	NUMBER(15,5)		Cleared MW of Unit in Dispatch, Predispatch or Trading period.
UNCONSTRAINEDMW	NUMBER(15,5)		MW output the generator would have been running at had it not been constrained up to provide unit unloading
CONTROLRANGE	NUMBER(4,0)		The MW output achieved in 5 minutes from startup and is what payment is based on.
ENABLINGPAYMENT	NUMBER(15,5)		Enabling payment
USAGEPAYMENT	NUMBER(15,5)		Usage Payment
COMPENSATIONPAYMENT	NUMBER(15,5)		Compensation payment
CONTRACTVERSIONNO	NUMBER(3,0)		Contract version number
OFFERDATE	DATE		Re-offer offer date
OFFERVERSIONNO	NUMBER(3,0)		Re-Offer Version No.
LASTCHANGED	DATE		Date last changed

26.35 Table: SETLUNLOADRECOVERY

26.35.1 SETLUNLOADRECOVERY

Name	SETLUNLOADRECOVERY
Comment	SETLUNLOADRECOVERY shows reimbursements for rapid unit unloading Ancillary Services to be recovered from participants.

26.35.2 Description

SETLUNLOADRECOVERY data is confidential to the relevant participant.

Source

SETLUNLOADRECOVERY updates with each settlement run.

26.35.3 Notes

Name	Comment	Value
Visibility	Data in this table is:	Private

26.35.4 Primary Key Columns

- Name
- PARTICIPANTID
- PERIODID
- REGIONID
- SETTLEMENTDATE
- VERSIONNO

26.35.5 Index Columns

- Name

LASTCHANGED

26.35.6 Content

Name	Data Type	Mandatory	Comment
SETTLEMENTDATE	DATE	X	Settlement Date
VERSIONNO	NUMBER(3,0)	X	Settlement Run No.
PARTICIPANTID	VARCHAR2(10)	X	Participant to pay recovery
CONTRACTID	VARCHAR2(10)		AS Contract
PERIODID	NUMBER(3,0)	X	Trading Interval
REGIONID	VARCHAR2(10)	X	Region Identifier
ENABLINGPAYMENT	NUMBER(15,5)		Enabling Payment
USAGEPAYMENT	NUMBER(15,5)		Usage Payment
COMPENSATIONPAYMENT	NUMBER(15,5)		Compensation Payment
PARTICIPANTDEMAND	NUMBER(15,5)		Participant Demand in Region
REGIONDEMAND	NUMBER(15,5)		Total Regional Demand
ENABLINGRECOVERY	NUMBER(15,5)		Enabling Recovery
USAGERECOVERY	NUMBER(15,5)		Usage Recovery
COMPENSATIONRECOVERY	NUMBER(15,5)		Compensation Recovery
LASTCHANGED	DATE		Last date and time record changed
ENABLINGRECOVERY_GEN	NUMBER(15,5)		Enabling Recovery for Generator

USAGERECOVERY_GEN	NUMBER(15,5)		Usage Recovery for Generator
COMPENSATIONRECOVER Y_GEN	NUMBER(15,5)		Compensation Recovery for Generator
PARTICIPANTDEMAND_GE N	NUMBER(15,5)		Participant Demand in Region for Generator
REGIONDEMAND_GEN	NUMBER(15,5)		Total Regional Demand for Generator

26.36 Table: SETMARKETFEEES

26.36.1 SETMARKETFEEES

Name	SETMARKETFEEES
Comment	SETMARKETFEEES shows payments for market fees for each settlement date.

26.36.2 Description

SETMARKETFEEES is confidential data.

Source

SETMARKETFEEES updates with each settlement run.

26.36.3 Notes

Name	Comment	Value
Visibility	Data in this table is:	Private

26.36.4 Primary Key Columns

Name

MARKETFEEID

PARTICIPANTCATEGORYID

PARTICIPANTID

PERIODID

RUNNO

SETTLEMENTDATE

26.36.5 Index Columns

Name

LASTCHANGED

26.36.6 Content

Name	Data Type	Mandatory	Comment
SETTLEMENTDATE	DATE	X	Settlement date
RUNNO	NUMBER(3,0)	X	Settlement run no
PARTICIPANTID	VARCHAR2(10)	X	Unique participant identifier
PERIODID	NUMBER(3,0)	X	Period identifier
MARKETFEEID	VARCHAR2(10)	X	Market fee identifier (e.g. V_EST)
MARKETFEEVALUE	NUMBER(15,5)		Fee charge
ENERGY	NUMBER(16,6)		Energy amount for variable fees
LASTCHANGED	DATE		Last date and time record changed
PARTICIPANTCATEGORYID	VARCHAR2(10)	X	The participant category that the market fee recovery pertains to. Corresponds to the PARTICIPANTCATEGORYID column of the PARTICIPANT_BANDFEE_CATEGORYALLOC_C_V view for BAND\$ type fees, or to the MARKETFEETYPE column of the MARKETFEE_P_V view for all other fee types.

26.37 Table: SETREALLOCATIONS

26.37.1 SETREALLOCATIONS

Name	SETREALLOCATIONS
Comment	SETREALLOCATIONS shows the trading interval value of reallocations processed, for those participants whose reallocation submissions have been accepted by AEMO.

26.37.2 Description

SETREALLOCATIONS data is confidential to participants party to the reallocation.

Source

SETREALLOCATIONS updates by the posting of a billing run.

Volume

Generally, there are approximately 550 records inserted per week.

26.37.3 Notes

Name	Comment	Value
Visibility	Data in this table is:	Private

26.37.4 Primary Key Columns

Name

PARTICIPANTID

PERIODID

REALLOCATIONID

RUNNO

SETTLEMENTDATE

26.37.5 Index Columns

Name

LASTCHANGED

26.37.6 Content

Name	Data Type	Mandatory	Comment
SETTLEMENTDATE	DATE	X	Calendar Settlement Date
RUNNO	NUMBER(3,0)	X	Settlement run no
PERIODID	NUMBER(3,0)	X	Settlement Period identifier
PARTICIPANTID	VARCHAR2(10)	X	Unique participant identifier
REALLOCATIONID	VARCHAR2(20)	X	Reallocation contract identifier
REALLOCATIONVALUE	NUMBER(15,5)		Reallocation value in \$
ENERGY	NUMBER(15,5)		Energy in MWh if reallocation agreement type is MWh
RRP	NUMBER(15,5)		Regional Reference Price
LASTCHANGED	DATE		Last date and time record changed

26.38 Table: SETRESERVERECOVERY

26.38.1 SETRESERVERECOVERY

Name	SETRESERVERECOVERY
Comment	SETRESERVERECOVERY shows reserve recovery details.

26.38.2 Description

SETRESERVERECOVERY is unused.

Source

Unused; was updated when reserve recovery occurred in a billing run.

26.38.3 Notes

Name	Comment	Value
Visibility	Data in this table is:	Private

26.38.4 Primary Key Columns

- Name
- CONTRACTID
- PARTICIPANTID
- PERIODID
- SETTLEMENTDATE
- VERSIONNO

26.38.5 Index Columns

- Name
- LASTCHANGED

26.38.6 Content

Name	Data Type	Mandatory	Comment
SETTLEMENTDATE	DATE	X	Settlement Date
VERSIONNO	NUMBER(3,0)	X	Settlement Run No.
PERIODID	NUMBER(3,0)	X	Period Identifier
CONTRACTID	VARCHAR2(10)	X	
RCF	CHAR(1)		Regional Recovery Flag
SPOTPAYMENT	NUMBER(12,5)		Cap difference for generator
PARTICIPANTID	VARCHAR2(10)	X	Unique participant identifier
PARTICIPANTDEMAND	NUMBER(12,5)		Demand of Participant in Region/Market
TOTALDEMAND	NUMBER(12,5)		Total Demand of Region/Market
RESERVEPAYMENT	NUMBER(12,5)		Payment made to generator for Reserve Trader Contract
RESERVEAMOUNT	NUMBER(12,5)		Payment owed by Retailer to pool for Reserve Trader Contract
LASTCHANGED	DATE		Last date and time record changed
REGIONID	VARCHAR2(10)		Region Identifier

26.39 Table: SETRESTARTPAYMENT

26.39.1 SETRESTARTPAYMENT

Name	SETRESTARTPAYMENT
Comment	SETRESTARTPAYMENT shows specific payment details for System Restart services by period.

26.39.2 Description

SETRESTARTPAYMENT data is confidential to the relevant participant.

Source

SETRESTARTPAYMENT updates with each settlement run.

26.39.3 Notes

Name	Comment	Value
Visibility	Data in this table is:	Private

26.39.4 Primary Key Columns

Name

CONTRACTID

PARTICIPANTID

PERIODID

SETTLEMENTDATE

VERSIONNO

26.39.5 Index Columns

Name

LASTCHANGED

26.39.6 Index Columns

Name

PARTICIPANTID

26.39.7 Content

Name	Data Type	Mandatory	Comment
SETTLEMENTDATE	DATE	X	Settlement Date
VERSIONNO	NUMBER(3,0)	X	Settlement Run No.
PARTICIPANTID	VARCHAR2(10)	X	Participant Identifier
CONTRACTID	VARCHAR2(10)	X	Contract Identifier
PERIODID	NUMBER(3,0)	X	Trading Interval
REGIONID	VARCHAR2(10)		Region Identifier
RESTARTTYPE	NUMBER(1,0)		System Restart Type (0 = FRC, 1 = GRC, 2 = TTH)
AVAFLAG	NUMBER(1,0)		Availability Flag
AVAILABILITYPRICE	NUMBER(15,5)		Availability Price
TCF	NUMBER(1,0)		Service Test Flag
AVAILABILITYPAYMENT	NUMBER(15,5)		Availability Payment
CONTRACTVERSIONNO	NUMBER(3,0)		Contract Version No.

OFFERDATE	DATE		Re-offer offer date
OFFERVERSIONNO	NUMBER(3,0)		Re-Offer Version No.
LASTCHANGED	DATE		Last date and time record changed
ENABLINGPAYMENT	NUMBER(18,8)		The enabling payment made for system restart in this half-hour interval

26.40 Table: SETRESTARTRECOVERY

26.40.1 SETRESTARTRECOVERY

Name	SETRESTARTRECOVERY
Comment	SETRESTARTRECOVERY shows reimbursements for system restart Ancillary Services to be recovered from participants. (Data no longer created for Settlement Days from 01/07/2012)

26.40.2 Description

SETRESTARTRECOVERY data is confidential to the relevant participant.

Source

SETRESTARTRECOVERY updates with each settlement run.

26.40.3 Notes

Name	Comment	Value
Visibility	Data in this table is:	Private

26.40.4 Primary Key Columns

- Name
- PARTICIPANTID
- PERIODID
- REGIONID
- SETTLEMENTDATE
- VERSIONNO

26.40.5 Index Columns

Name

LASTCHANGED

26.40.6 Content

Name	Data Type	Mandatory	Comment
SETTLEMENTDATE	DATE	X	Settlement Date
VERSIONNO	NUMBER(3,0)	X	Settlement Run No.
PARTICIPANTID	VARCHAR2(10)	X	Participant to pay recovery
CONTRACTID	VARCHAR2(10)		Contract Identifier
PERIODID	NUMBER(3,0)	X	Trading Interval
REGIONID	VARCHAR2(10)	X	Region Identifier
AVAILABILITYPAYMENT	NUMBER(15,5)		Availability Payment
PARTICIPANTDEMAND	NUMBER(15,5)		Participant Demand in Region
REGIONDEMAND	NUMBER(15,5)		NEM Demand (NB sum of ALL Regions)
AVAILABILITYRECOVERY	NUMBER(15,5)		Availability Recovery
LASTCHANGED	DATE		Last date and time record changed
AVAILABILITYRECOVERY_GEN	NUMBER(15,5)		Availability Recovery for Generator
PARTICIPANTDEMAND_GEN	NUMBER(15,5)		Participant Demand in Region for Generator

REGIONDEMAND_GEN	NUMBER(15,5)		Sum of all generation including SGA generation across all regions of the NEM and floored to zero
ENABLINGPAYMENT	NUMBER(18,8)		The enabling payment made for system restart in this half-hour interval
ENABLINGRECOVERY	NUMBER(18,8)		The enabling recovery amount for system restart in this half-hour interval attributable to customer activity
ENABLINGRECOVERY_GEN	NUMBER(18,8)		The enabling recovery amount for system restart in this half-hour interval attributable to generator activity

26.41 Table: SETRPOWERPAYMENT

26.41.1 SETRPOWERPAYMENT

Name	SETRPOWERPAYMENT
Comment	SETRPOWERPAYMENT shows specific payment details for Reactive power services by period.

26.41.2 Description

SETRPOWERPAYMENT data is confidential to the relevant participant.

Source

SETRPOWERPAYMENT updates with each settlement run.

26.41.3 Notes

Name	Comment	Value
Visibility	Data in this table is:	Private

26.41.4 Primary Key Columns

- Name
- CONTRACTID
- PARTICIPANTID
- PERIODID
- SETTLEMENTDATE
- VERSIONNO

26.41.5 Index Columns

- Name

LASTCHANGED

26.41.6 Content

Name	Data Type	Mandatory	Comment
SETTLEMENTDATE	DATE	X	Settlement Date
VERSIONNO	NUMBER(3,0)	X	Settlement Run No.
PARTICIPANTID	VARCHAR2(10)	X	Participant Identifier
CONTRACTID	VARCHAR2(10)	X	AS Contract Identifier
PERIODID	NUMBER(3,0)	X	Trading Interval
DUID	VARCHAR2(10)		Dispatchable Unit Identifier
REGIONID	VARCHAR2(10)		Region Identifier
TLF	NUMBER(7,5)		Transmission Loss Factor
EBP	NUMBER(15,5)		Eligible Bid Price
RRP	NUMBER(15,5)		Regional Reference Price
MVARAPRICE	NUMBER(15,5)		Availability price per MVar of RP absorption capability
MVAREPRICE	NUMBER(15,5)		Enabling Price
MVARGPRICE	NUMBER(15,5)		Availability price per MVar of RP generation capability
CCPRICE	NUMBER(15,5)		Compensation Cap
SYNCCOMPENSATION	NUMBER(1,0)		Sync Compensation Flag

MTA	NUMBER(15,5)		Reactive Power Absorption Capability (MVAR)
MTG	NUMBER(15,5)		Reactive Power Generation Capability (MVAR)
BLOCKSIZE	NUMBER(4,0)		Block size of unit
AVAFLAG	NUMBER(1,0)		Availability Flag
CLEAREDMW	NUMBER(15,5)		Cleared MW of unit
UNCONSTRAINEDMW	NUMBER(15,5)		Unconstrained MW of unit
AVAILABILITYPAYMENT	NUMBER(15,5)		Availability Payment
ENABLINGPAYMENT	NUMBER(15,5)		Enabling Payment
CCPAYMENT	NUMBER(15,5)		Compensation Payment
CONTRACTVERSIONNO	NUMBER(3,0)		AS Contract Version No.
OFFERDATE	DATE		Re-offer offer date
OFFERVERSIONNO	NUMBER(3,0)		Re-Offer Version No.
LASTCHANGED	DATE		Last date and time record changed
AVAILABILITYPAYMENT_REBATE	NUMBER(18,8)		The rebate amount if MegaVar (MVAR) is below the threshold.

26.42 Table: SETRPOWERRECOVERY

26.42.1 SETRPOWERRECOVERY

Name	SETRPOWERRECOVERY
Comment	SETRPOWERRECOVERY shows reimbursements for Reactive Power Ancillary Services to be recovered from participants. (Data no longer created for Settlement Days from 01/07/2012)

26.42.2 Description

SETRPOWERRECOVERY data is confidential to the relevant participant.

Source

SETRPOWERRECOVERY updates with each settlement run.

Note

Only the payment fields (AVAILABILITYPAYMENT, ENABLINGPAYMENT and CCPAYMENT) are on a regional basis. All other demand and recovery fields are on NEM basis rather than a regional basis.

26.42.3 Notes

Name	Comment	Value
Visibility	Data in this table is:	Private

26.42.4 Primary Key Columns

- Name
- PARTICIPANTID
- PERIODID
- REGIONID
- SETTLEMENTDATE
- VERSIONNO

26.42.5 Index Columns

Name

LASTCHANGED

26.42.6 Content

Name	Data Type	Mandatory	Comment
SETTLEMENTDATE	DATE	X	Settlement Date
VERSIONNO	NUMBER(3,0)	X	Settlement Run No.
PARTICIPANTID	VARCHAR2(10)	X	Participant to pay recovery
CONTRACTID	VARCHAR2(10)		AS Contract Identifier
PERIODID	NUMBER(3,0)	X	Trading Interval
REGIONID	VARCHAR2(10)	X	Region Identifier
AVAILABILITYPAYMENT	NUMBER(15,5)		Availability Payment
ENABLINGPAYMENT	NUMBER(15,5)		Enabling Payment
CCPAYMENT	NUMBER(15,5)		Compensation payment
PARTICIPANTDEMAND	NUMBER(15,5)		Total Participant NEM Demand
REGIONDEMAND	NUMBER(15,5)		Total NEM Demand
AVAILABILITYRECOVERY	NUMBER(15,5)		Availability Recovery
ENABLINGRECOVERY	NUMBER(15,5)		Enabling Recovery
CCRECOVERY	NUMBER(15,5)		Compensation Recovery
LASTCHANGED	DATE		Last date and time record changed

AVAILABILITYRECOVERY_GEN	NUMBER(15,5)		Availability Recovery for Generator
ENABLINGRECOVERY_GEN	NUMBER(15,5)		Enabling Recovery for Generator
CCRECOVERY_GEN	NUMBER(15,5)		Compensation Recovery for Generator
PARTICIPANTDEMAND_GEN	NUMBER(15,5)		Total Participant NEM Demand for Generator
REGIONDEMAND_GEN	NUMBER(15,5)		Total NEM Demand for Generator

26.43 Table: SETSMALLGENDATA

26.43.1 SETSMALLGENDATA

Name	SETSMALLGENDATA
Comment	Publishes metering data and associated settlement values for with a registered Small Generator Aggregator participants connection points.

26.43.2 Notes

Name	Comment	Value
Visibility	Data in this table is:	Private

26.43.3 Primary Key Columns

Name

CONNECTIONPOINTID

PARTICIPANTID

PERIODID

SETTLEMENTDATE

VERSIONNO

26.43.4 Content

Name	Data Type	Mandatory	Comment
SETTLEMENTDATE	DATE	X	Settlement date
VERSIONNO	NUMBER(3,0)	X	Version number of the record for the settlement date

CONNECTIONPOINTID	VARCHAR2(20))	X	Transmission Node Identifier (TNI)
PERIODID	NUMBER(3,0)	X	Settlement interval identifier (half hour period)
PARTICIPANTID	VARCHAR2(20))	X	Unique participant identifier
REGIONID	VARCHAR2(20))		Region Identifier
IMPORTENERGY	NUMBER(18,8)		The import direction value for the meter read (MWh)
EXPORTENERGY	NUMBER(18,8)		The export direction value for the meter read (MWh)
RRP	NUMBER(18,8)		Regional Reference Price
TLF	NUMBER(18,8)		Transmission Loss Factor
IMPENERGYCOST	NUMBER(18,8)		Import Energy Cost (\$)
EXPENERGYCOST	NUMBER(18,8)		Export Energy Cost (\$)
LASTCHANGED	DATE		Last date and time the record changed

26.44 Table: SETVICBOUNDARYENERGY

26.44.1 SETVICBOUNDARYENERGY

Name	SETVICBOUNDARYENERGY
Comment	SETVICBOUNDARYENERGY is as requested by Participants for the settlement of Victorian Vesting contracts.

26.44.2 Description

SETVICBOUNDARYENERGY data is confidential to the relevant participants.

Source

SETVICBOUNDARYENERGY is populated by the posting of a billing run.

Volume

Generally there are approximately 550 records inserted per week.

26.44.3 Notes

Name	Comment	Value
Visibility	Data in this table is:	Private

26.44.4 Primary Key Columns

- Name
- PARTICIPANTID
- PERIODID
- SETTLEMENTDATE
- VERSIONNO

26.44.5 Index Columns

- Name

LASTCHANGED

26.44.6 Content

Name	Data Type	Mandatory	Comment
SETTLEMENTDATE	DATE	X	Settlement and date
VERSIONNO	NUMBER(3,0)	X	Version number
PARTICIPANTID	VARCHAR2(10)	X	Participant Identifier
PERIODID	NUMBER(3,0)	X	Period Identifier
BOUNDARYENERGY	NUMBER(15,5)		Interval energy purchases in Victoria when host distributor = Pool (in MWh)
LASTCHANGED	DATE		Last changed

26.45 Table: SETVICENERGYFIGURES

26.45.1 SETVICENERGYFIGURES

Name	SETVICENERGYFIGURES
Comment	SETVICENERGYFIGURES is used in settlement of Victorian Vesting contracts.

26.45.2 Description

SETVICENERGYFIGURES data is public, so is available to all participants.

Source

SETVICENERGYFIGURES updates daily, with settlements.

26.45.3 Notes

Name	Comment	Value
Visibility	Data in this table is:	Public

26.45.4 Primary Key Columns

Name
 PERIODID
 SETTLEMENTDATE
 VERSIONNO

26.45.5 Index Columns

Name
 LASTCHANGED

26.45.6 Content

Name	Data Type	Mandatory	Comment
SETTLEMENTDATE	DATE	X	Settlement date
VERSIONNO	NUMBER(3,0)	X	Version number
PERIODID	NUMBER(3,0)	X	Settlement period
TOTALGENOUTPUT	NUMBER(15,5)		Total generator output
TOTALPCSD	NUMBER(15,5)		Total participant demand
LASTCHANGED	DATE		Last changed
TLR	NUMBER(15,6)		Transmission loss factor
MLF	NUMBER(15,6)		Marginal loss factor

26.46 Table: SETVICENERGYFLOW

26.46.1 SETVICENERGYFLOW

Name	SETVICENERGYFLOW
Comment	SETVICENERGYFLOW is used in settlement of Victorian Vesting contracts.

26.46.2 Description

SETVICENERGYFLOW data is public, so is available to all participants.

Source

SETVICENERGYFLOW updates daily, with settlements

26.46.3 Notes

Name	Comment	Value
Visibility	Data in this table is:	Public

26.46.4 Primary Key Columns

Name
 PERIODID
 SETTLEMENTDATE
 VERSIONNO

26.46.5 Index Columns

Name
 LASTCHANGED

26.46.6 Content

Name	Data Type	Mandatory	Comment
SETTLEMENTDATE	DATE	X	Settlement date
VERSIONNO	NUMBER(3,0)	X	Version number
PERIODID	NUMBER(3,0)	X	Settlement period
NETFLOW	NUMBER(15,5)		Net metered energy flowing across the V-SN and V-SA interconnectors
LASTCHANGED	DATE		Last changed

27 Package: STPASA_SOLUTION

<i>Name</i>	STPASA_SOLUTION
<i>Comment</i>	Results from a published Short Term PASA Run

27.1 List of tables

Name	Comment
STPASA_CASESOLUTION	STPASA_CASESOLUTION holds one record containing results pertaining to each entire solution
STPASA_CONSTRAINTSOLUTION	STPASA_CONSTRAINTSOLUTION shows binding and violated constraint results from the capacity evaluation, including the RHS value.
STPASA_INTERCONNECTORSOLUTION	STPASA_INTERCONNECTORSOLUTION shows the results of the capacity evaluation for Interconnectors, including the calculated limits for the interval.
STPASA_REGIONSOLUTION	STPASA_REGIONSOLUTION shows the results of the regional capacity, maximum surplus reserve and maximum spare capacity evaluations for each period of the study.

27.2 Diagram: Entities: ST PASA Solution

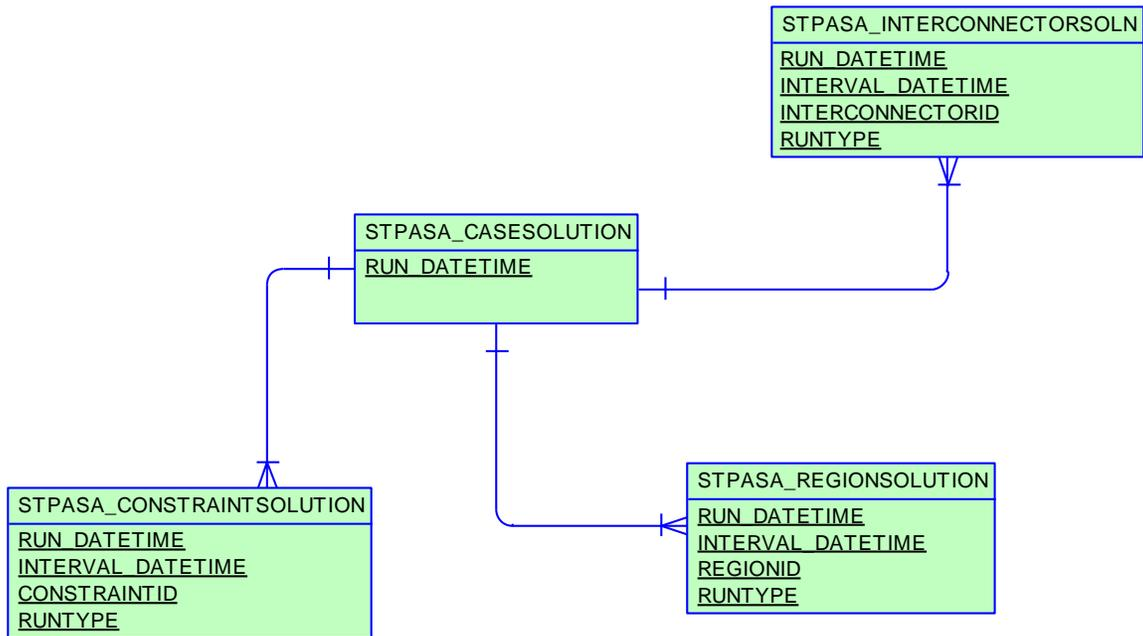

27.3 Table: STPASA_CASESOLUTION

27.3.1 STPASA_CASESOLUTION

Name	STPASA_CASESOLUTION
Comment	STPASA_CASESOLUTION holds one record containing results pertaining to each entire solution

27.3.2 Description

STPASA_CASESOLUTION is public data.

Source

STPASA_CASESOLUTION is updated each STPASA run (i.e. every 2 hours).

Volume

Rows per day: 12

Mb per month: <1

27.3.3 Notes

Name	Comment	Value
Visibility	Data in this table is:	Public

27.3.4 Primary Key Columns

Name
RUN_DATETIME

27.3.5 Index Columns

Name
LASTCHANGED

27.3.6 Content

Name	Data Type	Mandatory	Comment
RUN_DATETIME	DATE	X	Unique Timestamp Identifier for this study
PASAVERSION	VARCHAR2(10)		Version of the PASA solver used to solve this case
RESERVECONDITION	NUMBER(1,0)		Low Reserve Condition (LRC) flag for the case (1 - LRC in the case, 0 - No LRCs in the case) for capacity run
LORCONDITION	NUMBER(1,0)		Lack of Reserve Condition (LOR) flag for the case indicates the most severe condition in the case (3 = LOR3, 2 = LOR2, 1 = LOR1, 0 = No LOR)
CAPACITYOBJFUNCTION	NUMBER(12,3)		Objective Function from the Capacity Adequacy run
CAPACITYOPTION	NUMBER(12,3)		Not populated as of 2005 End of Year Release; was the demand forecast used for capacity adequacy assessment. 0 if no assessment, 1 for 10%, 2 for 50%, 3 for 90%
MAXSURPLUSRESERVEOPTION	NUMBER(12,3)		Not populated as of 2005 End of Year Release; was the demand forecast used for assessment of Maximum surplus Reserve. 0 if no assessment, 1 for 10%, 2 for 50%, 3 for 90%
MAXSPARECAPACITYOPTION	NUMBER(12,3)		Not populated as of 2005 End of Year Release; was the demand forecast used for assessment of

			Maximum Spare Capacity. 0 if no assessment, 1 for 10%, 2 for 50%, 3 for 90%
INTERCONNECTORFLOWPENALTY	NUMBER(12,3)		The penalty for non-zero interconnector flow
LASTCHANGED	DATE		Date and time the record was created or modified
RELIABILITYLRCDEMANDOPTION	NUMBER(12,3)		Specifies the Probability of Exceedence (POE) demand forecast for Reliability LRC assessment (0 if no assessment, 10 for 10%, 50 for 50%, 90 for 90%)
OUTAGELRCDEMANDOPTION	NUMBER(12,3)		Specifies the Probability of Exceedence (POE) demand forecast for outage LRC assessment (0 if no assessment, 10 for 10%, 50 for 50%, 90 for 90%)
LORDEMANDOPTION	NUMBER(12,3)		Specifies the Probability of Exceedence (POE) demand forecast for LOR assessment (0 if no assessment, 10 for 10%, 50 for 50%, 90 for 90%)
RELIABILITYLRCCAPACITYOPTION	VARCHAR2(10)		Generation Availability to be used in Reliability LRC run (either PASA or MARKET)
OUTAGELRCCAPACITYOPTION	VARCHAR2(10)		Generation Availability to be used in Outage LRC run (either PASA or MARKET)
LORCAPACITYOPTION	VARCHAR2(10)		Generation Availability to be used in LOR run (either PASA or MARKET)
LORUIGFOption	NUMBER(3,0)		UIGF POE forecast availability used for this option

ReliabilityLRCUIGFOption	NUMBER(3,0)		UIGF POE forecast availability used for this option
OutageLRCUIGFOption	NUMBER(3,0)		UIGF POE forecast availability used for this option

27.4 Table: STPASA_CONSTRAINTSOLUTION

27.4.1 STPASA_CONSTRAINTSOLUTION

Name	STPASA_CONSTRAINTSOLUTION
Comment	STPASA_CONSTRAINTSOLUTION shows binding and violated constraint results from the capacity evaluation, including the RHS value.

27.4.2 Description

STPASA_CONSTRAINTSOLUTION is public data.

Source

STPASA_CONSTRAINTSOLUTION is updated each STPASA run (i.e. every 2 hours).

Volume

Rows per day: 19000 (est.)

Mb per month: 90

27.4.3 Notes

Name	Comment	Value
Visibility	Data in this table is:	Public

27.4.4 Primary Key Columns

Name

CONSTRAINTID

INTERVAL_DATETIME

RUN_DATETIME

RUNTYPE

27.4.5 Index Columns

Name

LASTCHANGED

27.4.6 Content

Name	Data Type	Mandatory	Comment
RUN_DATETIME	DATE	X	Unique Timestamp Identifier for this study
INTERVAL_DATETIME	DATE	X	The unique identifier for the interval within this study
CONSTRAINTID	VARCHAR2(20)	X	Constraint identifier (synonymous with GenConID)
CAPACITYRHS	NUMBER(12,2)		The RHS value in the capacity evaluation.
CAPACITYMARGINALVALUE	NUMBER(12,2)		Capacity adequacy assessment marginal value, 0 if not binding
CAPACITYVIOLATIONDEGREE	NUMBER(12,2)		Capacity adequacy assessment violation degree for generic constraint; 0 if not violating
LASTCHANGED	DATE		Last changed date of this record
RUNTYPE	VARCHAR2(20)	X	Type of run. Values are RELIABILITY_LRC and OUTAGE_LRC

27.5 Table: STPASA_INTERCONNECTORSOLN

27.5.1 STPASA_INTERCONNECTORSOLN

Name	STPASA_INTERCONNECTORSOLN
Comment	STPASA_INTERCONNECTORSOLN shows the results of the capacity evaluation for Interconnectors, including the calculated limits for the interval.

27.5.2 Description

STPASA_INTERCONNECTORSOLN is public so is available to all participants.

Source

STPASA_INTERCONNECTORSOLN is updated each STPASA run (i.e. every 2 hours).

Volume

Rows per day: 576

Mb per month: 4

27.5.3 Notes

Name	Comment	Value
Visibility	Data in this table is:	Public

27.5.4 Primary Key Columns

- Name
- INTERCONNECTORID
- INTERVAL_DATETIME
- RUN_DATETIME
- RUNTYPE

27.5.5 Index Columns

Name

LASTCHANGED

27.5.6 Content

Name	Data Type	Mandatory	Comment
RUN_DATETIME	DATE	X	Unique Timestamp Identifier for this study
INTERVAL_DATETIME	DATE	X	The unique identifier for the interval within this study
INTERCONNECTORID	VARCHAR2(10)	X	Interconnector Identifier
CAPACITYMWFLOW	NUMBER(12,2)		Interconnector loading level (MW) that can be reached in case of capacity scarcity in neighbouring regions subject to network and energy constraints
CAPACITYMARGINALVALUE	NUMBER(12,2)		Capacity adequacy assessment marginal value, 0 if not binding
CAPACITYVIOLATIONDEGREE	NUMBER(12,2)		Capacity adequacy assessment violation degree for interconnector capacity; 0 if not violating
CALCULATEDEXPORTLIMIT	NUMBER(12,2)		Calculated Interconnector limit of exporting energy on the basis of invoked constraints and static interconnector export limit
CALCULATEDIMPORTLIMIT	NUMBER(12,2)		Calculated Interconnector limit of importing energy on the basis of invoked constraints and static interconnector import limit. Note

			unlike the input interconnector import limit this is a directional quantity and should be defined with respect to the interconnector flow.
LASTCHANGED	DATE		Last changed date of this record
RUNTYPE	VARCHAR2(20)	X	Type of run. Values are RELIABILITY_LRC and OUTAGE_LRC
EXPORTLIMITCONSTRAINT ID	VARCHAR2(20)		ID of the constraint that sets the Interconnector Export Limit
IMPORTLIMITCONSTRAINT ID	VARCHAR2(20)		ID of the constraint that sets the Interconnector Import Limit

27.6 Table: STPASA_REGIONSOLUTION

27.6.1 STPASA_REGIONSOLUTION

Name	STPASA_REGIONSOLUTION
Comment	STPASA_REGIONSOLUTION shows the results of the regional capacity, maximum surplus reserve and maximum spare capacity evaluations for each period of the study.

27.6.2 Description

STPASA_REGIONSOLUTION is public so is available to all participants.

Source

STPASA_REGIONSOLUTION is updated each STPASA run (i.e every 2 hours).

Volume

Rows per day: 480

Mb per month: 8

27.6.3 Notes

Name	Comment	Value
Visibility	Data in this table is:	Public

27.6.4 Primary Key Columns

- Name
- INTERVAL_DATETIME
- REGIONID
- RUN_DATETIME
- RUNTYPE

27.6.5 Index Columns

Name

LASTCHANGED

27.6.6 Content

Name	Data Type	Mandatory	Comment
RUN_DATETIME	DATE	X	Unique Timestamp Identifier for this study
INTERVAL_DATETIME	DATE	X	The unique identifier for the interval within this study
REGIONID	VARCHAR2(10)	X	Region Identifier
DEMAND10	NUMBER(12,2)		Input value for 10% probability demand
DEMAND50	NUMBER(12,2)		Input value for 50% probability demand
DEMAND90	NUMBER(12,2)		Input value for 90% probability demand
RESERVEREQ	NUMBER(12,2)		Input reserve requirement
CAPACITYREQ	NUMBER(12,2)		Demand + Reserve Requirement
ENERGYREQDEMAND50	NUMBER(12,2)		Sum of: (Region Period Demand - given Demand50)/Period (sum by trading day, entered in first period of trading day, GWh)
UNCONSTRAINEDCAPACITY	NUMBER(12,0)		Region energy unconstrained MW capacity subject to energy and network security constraints

CONSTRAINEDCAPACITY	NUMBER(12,0)		Available capacity (MW) in this region energy constrained MW capacity subject to energy and network security constraints
NETINTERCHANGEUNDER SCARCITY	NUMBER(12,2)		Net export in MW out of this region in the capacity adequacy evaluation. Export if > 0, Import if < 0.
SURPLUSCAPACITY	NUMBER(12,2)		Regional surplus capacity MW, +/- values indicate surplus/deficit capacity respectively
SURPLUSRESERVE	NUMBER(12,2)		Regional reserve surplus. +/- values indicate surplus/deficit reserve respectively
RESERVECONDITION	NUMBER(1,0)		The regional reserve condition: 0 Adequate, 1 LRC
MAXSURPLUSRESERVE	NUMBER(12,2)		The Maximum Surplus Reserve evaluated for this region in this period. Calculated for each region in turn.
MAXSPARECAPACITY	NUMBER(12,2)		The Maximum Spare Capacity evaluated for this region in this period. Calculated for each region in turn.
LORCONDITION	NUMBER(1,0)		The LOR Condition determined from the Maximum Spare Capacity value: 0 - no condition, 1 - LOR1 condition, 2 - LOR2 condition, 3 - LOR3 condition
AGGREGATECAPACITYAVAILABLE	NUMBER(12,2)		Sum of MAXAVAIL quantities offered by all Scheduled Generators in a given Region for a given PERIODID.

AGGREGATESCHEDULEDLOAD	NUMBER(12,2)		Sum of MAXAVAIL quantities bid by of all Scheduled Loads in a given Region for a given PERIODID.
LASTCHANGED	DATE		Last changed date of this record
AGGREGATEPASA AVAILABILITY	NUMBER(12,0)		Sum of PASAAVAILABILITY quantities offered by all Scheduled Generators in a given Region for a given PERIODID.
RUNTYPE	VARCHAR2(20)	X	Type of run. Values are RELIABILITY_LRC and OUTAGE_LRC
ENERGYREQDEMAND10	NUMBER(12,2)		Energy (GWh) required for this energy block based on the 10% probability of exceedance demand. Listed in the first interval of the energy block
CALCULATEDLOR1LEVEL	NUMBER(16,6)		Region Reserve Level for LOR1 used. Can be static value or calculated value if an interconnector is a credible contingency
CALCULATEDLOR2LEVEL	NUMBER(16,6)		Region Reserve Level for LOR2 used. Can be static value or calculated value if an interconnector is a credible contingency
MSRNETINTERCHANGEUN DERSCARCITY	NUMBER(12,2)		Net interconnector flow from the region for this interval from the MSR assessment
LORNETINTERCHANGEUN DERSCARCITY	NUMBER(12,2)		Net interconnector flow from the region for this interval from the LOR assessment

TOTALINTERMITTENTGENERATION	NUMBER(15,5)		Allowance made for non-scheduled generation in the demand forecast (MW).
DEMAND_AND_NONSCHEDULEDGEN	NUMBER(15,5)		Sum of Cleared Scheduled generation, imported generation (at the region boundary) and allowances made for non-scheduled generation (MW).
UIGF	NUMBER(12,2)		Regional aggregated Unconstrained Intermittent Generation Forecast of Semi-scheduled generation (MW).
SemiScheduledCapacity	NUMBER(12,2)		Aggregate Regional UIGF availability
LOR_SemiScheduledCapacity	NUMBER(12,2)		Aggregate Regional UIGF availability for LOR
LCR	NUMBER(16,6)		Largest Credible Risk. MW value for highest credible contingency
LCR2	NUMBER(16,6)		Two Largest Creditable Risks. MW value for highest two credible contingencies.
FUM	NUMBER(16,6)		Forecasting Uncertainty Measure. MW value of reserve calculated as defined in the Reserve Level Declaration Guidelines
SS_SOLAR_UIGF	Number(12,2)		Regional aggregated Unconstrained Intermittent Generation Forecast of Semi-scheduled generation (MW) where the primary fuel source is solar
SS_WIND_UIGF	Number (12,2)		Regional aggregated Unconstrained Intermittent Generation Forecast of Semi-

			scheduled generation (MW) where the primary fuel source is wind
SS_SOLAR_CAPACITY	Number (12,2)		Regional aggregated Semi-scheduled UIGF availability where the primary fuel source is solar
SS_WIND_CAPACITY	Number (12,2)		Regional aggregated Semi-scheduled UIGF availability where the primary fuel source is wind
SS_SOLAR_CLEARED	Number (12,2)		Regional aggregated Semi-scheduled cleared MW where the primary fuel source is solar and StudyRegion = Region
SS_WIND_CLEARED	Number (12,2)		Regional aggregated Semi-scheduled cleared MW where the primary fuel source is wind and StudyRegion = Region

28 Package: TRADING_DATA

<i>Name</i>	TRADING_DATA
<i>Comment</i>	30 minute Trading interval results

28.1 List of tables

Name	Comment
TRADINGINTERCONNECT	TRADINGINTERCONNECT shows the half-hourly summary of Interconnector flows based on 5-minute averages.
TRADINGLOAD	TRADINGLOAD shows half-hourly average dispatch levels, including fields to handle the Ancillary Services functionality.
TRADINGPRICE	TRADINGPRICE sets out half-hourly spot market price, including fields to handle the Ancillary Services functionality. If prices are adjusted, the final price is recorded in the regional reference price (RRP) field with price before adjustment recorded in the regional original price (ROP) field.
TRADINGREGIONSUM	TRADINGREGIONSUM sets out the half-hourly average regional demand and frequency control services. TRADINGREGIONSUM includes fields for the Raise Regulation and Lower Regulation Ancillary Services plus improvements to demand calculations.

28.2 Diagram: Entities: Trading Data

TRADINGINTERCONNECT
<u>SETTLEMENTDATE</u>
<u>RUNNO</u>
<u>INTERCONNECTORID</u>
<u>PERIODID</u>

TRADINGLOAD
<u>SETTLEMENTDATE</u>
<u>RUNNO</u>
<u>DUID</u>
<u>TRADETYPE</u>
<u>PERIODID</u>

TRADINGPRICE
<u>SETTLEMENTDATE</u>
<u>RUNNO</u>
<u>REGIONID</u>
<u>PERIODID</u>

TRADINGREGIONSUM
<u>SETTLEMENTDATE</u>
<u>RUNNO</u>
<u>REGIONID</u>
<u>PERIODID</u>

28.3 Table: TRADINGINTERCONNECT

28.3.1 TRADINGINTERCONNECT

Name	TRADINGINTERCONNECT
Comment	TRADINGINTERCONNECT shows the half-hourly summary of Interconnector flows based on 5-minute averages.

28.3.2 Description

TRADINGINTERCONNECT is public data, and is available to all participants.

Source

TRADINGINTERCONNECT is updated half hourly.

28.3.3 Notes

Name	Comment	Value
Visibility	Data in this table is:	Public

28.3.4 Primary Key Columns

Name

INTERCONNECTORID

PERIODID

RUNNO

SETTLEMENTDATE

28.3.5 Index Columns

Name

LASTCHANGED

28.3.6 Content

Name	Data Type	Mandatory	Comment
SETTLEMENTDATE	DATE	X	Date that this data applies to
RUNNO	NUMBER(3,0)	X	Dispatch run no.
INTERCONNECTORID	VARCHAR2(10)	X	Interconnector identifier
PERIODID	NUMBER(3,0)	X	Period Identifier
METEREDMWFLOW	NUMBER(15,5)		Average of the metered MW flow from the start of each dispatch interval.
MWFLOW	NUMBER(15,5)		Calculated MW Flow from SPD
MWLOSSES	NUMBER(15,5)		MW losses at calculated MW flow
LASTCHANGED	DATE		Last date and time record changed

28.4 Table: TRADINGLOAD

28.4.1 TRADINGLOAD

Name	TRADINGLOAD
Comment	TRADINGLOAD shows half-hourly average dispatch levels, including fields to handle the Ancillary Services functionality.

28.4.2 Description

Source

Own (confidential) TRADINGLOAD data updates half hourly, with public availability of all data on next day.

28.4.3 Notes

Name	Comment	Value
Visibility	Data in this table is:	Private; Public Next-Day

28.4.4 Primary Key Columns

Name
 DUID
 PERIODID
 RUNNO
 SETTLEMENTDATE
 TRADETYPE

28.4.5 Index Columns

Name

LASTCHANGED

28.4.6 Index Columns

Name

DUID

LASTCHANGED

28.4.7 Content

Name	Data Type	Mandatory	Comment
SETTLEMENTDATE	DATE	X	Date that this data applies to
RUNNO	NUMBER(3,0)	X	Dispatch run no.
DUID	VARCHAR2(10)	X	Dispatchable Unit Identifier
TRADETYPE	NUMBER(2,0)	X	Not used
PERIODID	NUMBER(3,0)	X	Period Identifier
INITIALMW	NUMBER(15,5)		Average Initial MW at start of each period
TOTALCLEARED	NUMBER(15,5)		Average total MW dispatched over period
RAMPDOWNRATE	NUMBER(15,5)		Average ramp down rate
RAMPUPRATE	NUMBER(15,5)		Average ramp up rate
LOWER5MIN	NUMBER(15,5)		Average 5 min lower dispatch
LOWER60SEC	NUMBER(15,5)		Average 60 sec lower dispatch
LOWER6SEC	NUMBER(15,5)		Average 60 sec lower dispatch

RAISE5MIN	NUMBER(15,5)		Average 5 min raise dispatch
RAISE60SEC	NUMBER(15,5)		Average 60 sec raise dispatch
RAISE6SEC	NUMBER(15,5)		Average 6 sec raise dispatch
LASTCHANGED	DATE		Last date and time record changed
LOWERREG	NUMBER(15,5)		Lower Regulation reserve target
RAISEREG	NUMBER(15,5)		Raise Regulation reserve target
AVAILABILITY	NUMBER(15,5)		Bid energy availability
SEMIDISPATCHCAP	NUMBER(3,0)		Boolean representation flagging if the Target is Capped

28.5 Table: TRADINGPRICE

28.5.1 TRADINGPRICE

Name	TRADINGPRICE
Comment	TRADINGPRICE sets out half-hourly spot market price, including fields to handle the Ancillary Services functionality. If prices are adjusted, the final price is recorded in the regional reference price (RRP) field with price before adjustment recorded in the regional original price (ROP) field.

28.5.2 Description

TRADINGPRICE data is public, so is available to all participants.

Source

TRADINGPRICE updates every 30 minutes.

Notes

INVALIDFLAG

The INVALIDFLAG field is used to indicate whether the Trading interval price has been adjusted after the trading interval was completed. On a very restricted set of events, the market rules allow a dispatch price (5 min) to be adjusted on the next business day, and, when this occurs, the corresponding trading interval price for that region is also adjusted and marked as adjusted with INVALIDFLAG of 'A'.

The INVALIDFLAG = 'Y' only applies to historical periods when not all six of the 5-minute dispatch intervals were run in the trading interval. System changes implemented on 30 September 2001 mean this situation no longer occurs since missing dispatch intervals are automatically populated from a previous interval.

If the INVALIDFLAG field = '0', the price was not adjusted and all six dispatch intervals are present.

Prices

There is no field in the TRADINGPRICE table (or the MMS data model anywhere) telling you that the price is provisional or final. The only reliable method is to ensure that the trading date is at least 2 business days old.

28.5.3 Notes

Name	Comment	Value
Visibility	Data in this table is:	Public

28.5.4 Primary Key Columns

Name

PERIODID

REGIONID

RUNNO

SETTLEMENTDATE

28.5.5 Index Columns

Name

LASTCHANGED

28.5.6 Content

Name	Data Type	Mandatory	Comment
SETTLEMENTDATE	DATE	X	Date that this data applies to
RUNNO	NUMBER(3,0)	X	Run No
REGIONID	VARCHAR2(10)	X	Region Identifier
PERIODID	NUMBER(3,0)	X	Trading Interval Period
RRP	NUMBER(15,5)		Regional reference price for this dispatch period
EEP	NUMBER(15,5)		Excess energy price where negative average
INVALIDFLAG	VARCHAR2(1)		Indicates when the Trading interval price has been adjusted after the trading interval was completed

LASTCHANGED	DATE		Last date and time record changed
ROP	NUMBER(15,5)		Regional Original Price. The price before any adjustments were made
RAISE6SECRRP	NUMBER(15,5)		Regional reference price for this dispatch period
RAISE6SECROP	NUMBER(15,5)		Original regional price - prior to APC or VoLL overrides applied
RAISE60SECRRP	NUMBER(15,5)		Regional reference price for this dispatch period
RAISE60SECROP	NUMBER(15,5)		Original regional price - prior to APC or VoLL overrides applied
RAISE5MINRRP	NUMBER(15,5)		Regional reference price for this dispatch period
RAISE5MINROP	NUMBER(15,5)		Original regional price - prior to APC or VoLL overrides applied
RAISEREGRRP	NUMBER(15,5)		Regional reference price for this dispatch period
RAISEREGROP	NUMBER(15,5)		Original regional price - prior to APC or VoLL overrides applied
LOWER6SECRRP	NUMBER(15,5)		Regional reference price for this dispatch period
LOWER6SECROP	NUMBER(15,5)		Original regional price - prior to APC or VoLL overrides applied
LOWER60SECRRP	NUMBER(15,5)		Regional reference price for this dispatch period
LOWER60SECROP	NUMBER(15,5)		Original regional price - prior to APC or VoLL overrides applied
LOWER5MINRRP	NUMBER(15,5)		Regional reference price for this

			dispatch period
LOWER5MINROP	NUMBER(15,5)		Original regional price - prior to APC or VoLL overrides applied
LOWERREGRRP	NUMBER(15,5)		Regional reference price for this dispatch period
LOWERREGROP	NUMBER(15,5)		Original regional price - prior to APC or VoLL overrides applied
PRICE_STATUS	VARCHAR2(20)		Status of regional prices for this dispatch interval "NOT FIRM" or "FIRM"

28.6 Table: TRADINGREGIONSUM

28.6.1 TRADINGREGIONSUM

Name	TRADINGREGIONSUM
Comment	TRADINGREGIONSUM sets out the half-hourly average regional demand and frequency control services. TRADINGREGIONSUM includes fields for the Raise Regulation and Lower Regulation Ancillary Services plus improvements to demand calculations.

28.6.2 Description

TRADINGREGIONSUM is public data, and is available to all participants.

Source

TRADINGREGIONSUM is updated every 30 minutes.

28.6.3 Notes

Name	Comment	Value
Visibility	Data in this table is:	Public

28.6.4 Primary Key Columns

- Name
- PERIODID
- REGIONID
- RUNNO
- SETTLEMENTDATE

28.6.5 Index Columns

- Name

LASTCHANGED

28.6.6 Content

Name	Data Type	Mandatory	Comment
SETTLEMENTDATE	DATE	X	Date that this data applies to
RUNNO	NUMBER(3,0)	X	Dispatch run no.
REGIONID	VARCHAR2(10)	X	Region Identifier
PERIODID	NUMBER(3,0)	X	Trading interval identifier within settlement day.
TOTALDEMAND	NUMBER(15,5)		Total demand for region
AVAILABLEGENERATION	NUMBER(15,5)		The available generation in the Region for the interval
AVAILABLELOAD	NUMBER(15,5)		Not used
DEMANDFORECAST	NUMBER(15,5)		Forecast demand for region
DISPATCHABLEGENERATION	NUMBER(15,5)		Averaged generation dispatched in region
DISPATCHABLELOAD	NUMBER(15,5)		Averaged load dispatched in region
NETINTERCHANGE	NUMBER(15,5)		Average energy transferred over interconnector
EXCESSGENERATION	NUMBER(15,5)		Average excess generation in region
LOWER5MINDISPATCH	NUMBER(15,5)		Not used since Dec 2003. Lower 5 min MW dispatch

LOWER5MINIMPORT	NUMBER(15,5)		Not used since Dec 2003. Lower 5 min MW imported
LOWER5MINLOCALDISPATCH	NUMBER(15,5)		Lower 5 min local dispatch
LOWER5MINLOCALPRICE	NUMBER(15,5)		Not used since Dec 2003. Local price of lower 5 min
LOWER5MINLOCALREQ	NUMBER(15,5)		Not used since Dec 2003. Lower 5 min local requirement
LOWER5MINPRICE	NUMBER(15,5)		Not used since Dec 2003. Regional price of lower 5 min
LOWER5MINREQ	NUMBER(15,5)		Not used since Dec 2003. Lower 5 min total requirement
LOWER5MINSUPPLYPRICE	NUMBER(15,5)		Not used since Dec 2003. Supply price of lower 5 min
LOWER60SECDISPATCH	NUMBER(15,5)		Not used since Dec 2003. Lower 60 sec MW dispatch
LOWER60SECIMPORT	NUMBER(15,5)		Not used since Dec 2003. Lower 60 sec MW imported
LOWER60SECLOCALDISPATCH	NUMBER(15,5)		Lower 60 sec local dispatch
LOWER60SECLOCALPRICE	NUMBER(15,5)		Not used since Dec 2003. Local price of lower 60 sec
LOWER60SECLOCALREQ	NUMBER(15,5)		Not used since Dec 2003. Lower 60 sec local requirement
LOWER60SECPRICE	NUMBER(15,5)		Not used since Dec 2003. Regional price of lower 60 sec
LOWER60SECREQ	NUMBER(15,5)		Not used since Dec 2003. Lower 60 sec total requirement

LOWER60SECSUPPLYPRICE	NUMBER(15,5)		Not used since Dec 2003. Supply price of lower 60 sec
LOWER6SECDISPATCH	NUMBER(15,5)		Not used since Dec 2003. Lower 6 sec MW dispatch
LOWER6SECIMPORT	NUMBER(15,5)		Not used since Dec 2003. Lower 6 sec MW imported
LOWER6SECLOCALDISPATCH	NUMBER(15,5)		Lower 6 sec local dispatch
LOWER6SECLOCALPRICE	NUMBER(15,5)		Not used since Dec 2003. Local price of lower 6 sec
LOWER6SECLOCALREQ	NUMBER(15,5)		Not used since Dec 2003. Lower 6 sec local requirement
LOWER6SECPRICE	NUMBER(15,5)		Not used since Dec 2003. Regional price of lower 6 sec
LOWER6SECREQ	NUMBER(15,5)		Not used since Dec 2003. Lower 6 sec total requirement
LOWER6SECSUPPLYPRICE	NUMBER(15,5)		Not used since Dec 2003. Supply price of lower 6 sec
RAISE5MINDISPATCH	NUMBER(15,5)		Not used since Dec 2003. Raise 5 min MW dispatch
RAISE5MINIMPORT	NUMBER(15,5)		Not used since Dec 2003. Raise 5 min MW imported
RAISE5MINLOCALDISPATCH	NUMBER(15,5)		Raise 5 min local dispatch
RAISE5MINLOCALPRICE	NUMBER(15,5)		Not used since Dec 2003. Local price of raise 5 min
RAISE5MINLOCALREQ	NUMBER(15,5)		Not used since Dec 2003. Raise 5 min local requirement

RAISE5MINPRICE	NUMBER(15,5)		Not used since Dec 2003. Regional price of raise 5 min
RAISE5MINREQ	NUMBER(15,5)		Not used since Dec 2003. Raise 5 min total requirement
RAISE5MINSUPPLYPRICE	NUMBER(15,5)		Not used since Dec 2003. Supply price of raise 5 min
RAISE60SECDISPATCH	NUMBER(15,5)		Not used since Dec 2003. Raise 60 sec MW dispatch
RAISE60SECIMPORT	NUMBER(15,5)		Not used since Dec 2003. Raise 60 sec MW imported
RAISE60SECLOCALDISPATCH	NUMBER(15,5)		Raise 60 sec local dispatch
RAISE60SECLOCALPRICE	NUMBER(15,5)		Not used since Dec 2003. Local price of raise 60 sec
RAISE60SECLOCALREQ	NUMBER(15,5)		Not used since Dec 2003. Raise 60 sec local requirement
RAISE60SECPRICE	NUMBER(15,5)		Not used since Dec 2003. Regional price of raise 60 sec
RAISE60SECREQ	NUMBER(15,5)		Not used since Dec 2003. Raise 60 sec total requirement
RAISE60SECSUPPLYPRICE	NUMBER(15,5)		Not used since Dec 2003. Supply price of raise 60 sec
RAISE6SECDISPATCH	NUMBER(15,5)		Not used since Dec 2003. Raise 6 sec MW dispatch
RAISE6SECIMPORT	NUMBER(15,5)		Not used since Dec 2003. Raise 6 sec MW imported
RAISE6SECLOCALDISPATCH	NUMBER(15,5)		Raise 6 sec local dispatch

RAISE6SECLOCALPRICE	NUMBER(15,5)		Not used since Dec 2003. Local price of raise 6 sec
RAISE6SECLOCALREQ	NUMBER(15,5)		Not used since Dec 2003. Raise 6 sec local requirement
RAISE6SECPRICE	NUMBER(15,5)		Not used since Dec 2003. Regional price of raise 6 sec
RAISE6SECREQ	NUMBER(15,5)		Not used since Dec 2003. Raise 6 sec total requirement
RAISE6SECSUPPLYPRICE	NUMBER(15,5)		Not used since Dec 2003. Supply price of raise 6 sec
LASTCHANGED	DATE		Last date and time record changed
INITIALSUPPLY	NUMBER(15,5)		Sum of initial generation and import for region
CLEAREDSUPPLY	NUMBER(15,5)		Sum of cleared generation and import for region
LOWERREGIMPORT	NUMBER(15,5)		Not used since Dec 2003. Lower Regulation MW imported
LOWERREGLOCALDISPATCH	NUMBER(15,5)		Lower Regulation local dispatch
LOWERREGLOCALREQ	NUMBER(15,5)		Not used since Dec 2003. Lower Regulation local requirement
LOWERREGREQ	NUMBER(15,5)		Not used since Dec 2003. Lower Regulation total requirement
RAISEREGIMPORT	NUMBER(15,5)		Not used since Dec 2003. Raise Regulation MW imported
RAISEREGLOCALDISPATCH	NUMBER(15,5)		Raise Regulation local dispatch
RAISEREGLOCALREQ	NUMBER(15,5)		Not used since Dec 2003. Raise Regulation local requirement

RAISEREGREQ	NUMBER(15,5)		Not used since Dec 2003. Raise Regulation total requirement
RAISE5MINLOCALVIOLATION	NUMBER(15,5)		Not used since Dec 2003. Violation (MW) of Raise 5 min local requirement
RAISEREGLOCALVIOLATION	NUMBER(15,5)		Not used since Dec 2003. Violation (MW) of Raise Reg local requirement
RAISE60SECLOCALVIOLATION	NUMBER(15,5)		Not used since Dec 2003. Violation (MW) of Raise 60 sec local requirement
RAISE6SECLOCALVIOLATION	NUMBER(15,5)		Not used since Dec 2003. Violation (MW) of Raise 6 sec local requirement
LOWER5MINLOCALVIOLATION	NUMBER(15,5)		Not used since Dec 2003. Violation (MW) of Lower 5 min local requirement
LOWERREGLOCALVIOLATION	NUMBER(15,5)		Not used since Dec 2003. Violation (MW) of Lower Reg local requirement
LOWER60SECLOCALVIOLATION	NUMBER(15,5)		Not used since Dec 2003. Violation (MW) of Lower 60 sec local requirement
LOWER6SECLOCALVIOLATION	NUMBER(15,5)		Not used since Dec 2003. Violation (MW) of Lower 6 sec local requirement
RAISE5MINVIOLATION	NUMBER(15,5)		Not used since Dec 2003. Violation (MW) of Raise 5 min requirement
RAISEREGVIOLATION	NUMBER(15,5)		Not used since Dec 2003. Violation (MW) of Raise Reg requirement
RAISE60SECVIOLATION	NUMBER(15,5)		Not used since Dec 2003. Violation

			(MW) of Raise 60 seconds requirement
RAISE6SECVIOLATION	NUMBER(15,5)		Not used since Dec 2003. Violation (MW) of Raise 6 seconds requirement
LOWER5MINVIOLATION	NUMBER(15,5)		Not used since Dec 2003. Violation (MW) of Lower 5 min requirement
LOWERREGVIOLATION	NUMBER(15,5)		Not used since Dec 2003. Violation (MW) of Lower Reg requirement
LOWER60SECVIOLATION	NUMBER(15,5)		Not used since Dec 2003. Violation (MW) of Lower 60 seconds requirement
LOWER6SECVIOLATION	NUMBER(15,5)		Not used since Dec 2003. Violation (MW) of Lower 6 seconds requirement
TOTALINTERMITTENTGENERATION	NUMBER(15,5)		Allowance made for non-scheduled generation in the demand forecast (MW).
DEMAND_AND_NONSCHE DGEN	NUMBER(15,5)		Sum of Cleared Scheduled generation, imported generation (at the region boundary) and allowances made for non-scheduled generation (MW).
UIGF	NUMBER(15,5)		Regional aggregated Unconstrained Intermittent Generation Forecast of Semi-scheduled generation (MW).

29 Package: HISTORICAL TABLES

<i>Name</i>	HISTORICAL TABLES
<i>Comment</i>	These tables are no longer used

29.1 List of tables

Name	Comment
APCCOMP	APCCOMP is to set out Administered Price Cap (APC) compensation periods for a participant.
APCCOMPAMOUNT	APCCOMPAMOUNT shows the Administered Price Cap (APC) compensation amount.
APCCOMPAMOUNTTRK	APCCOMPAMOUNTTRK sets out the relevant Administered Price Cap (APC) period for compensation purposes. Use the APCCOMPAMOUNTTRK table in conjunction with APCAMOUNT.
BILLADJUSTMENTS	
BILLING_CSP_DEROGATION_AMOUNT	CSP derogation amounts with respect to participant allocated payment
BILLINGCPSUM	BILLINGCPSUM shows adjustments for a billing run by participant.
BILLINGCUSTEXCESSGEN	BILLINGCUSTEXCESSGEN shows excess generation payments for each participant cutover.
BILLINGEXCESSGEN	BILLINGEXCESSGEN shows the excess generation cost by period for each participant.
BILLINGINTERVENTION	BILLINGINTERVENTION shows billing intervention recovery details.
BILLINGINTERVENTIONREGION	BILLINGINTERVENTIONREGION shows recovery charges

	for region intervention.
BILLINGRESERVERECOVERY	BILLINGRESERVERECOVERY shows Market Reserve recovery details for each participant in a bill run.
BILLINGRESERVEREGIONRECOVERY	BILLINGRESERVEREGIONRECOVERY shows Billing Region Reserve region recovery details for each participant (by region).
BILLINGRESERVETRADER	BILLINGRESERVETRADER shows Billing Market Reserve TRADER payment details to Generators.
BILLINGRESERVETRADERREGION	BILLINGRESERVETRADERREGION shows Billing Region Reserve Trader payment details.
BILLINTERVENTIONRECOVERY	BILLINTERVENTIONRECOVERY shows billing market intervention recovery details for each participant.
BILLINTERVENTIONREGIONRECOVERY	BILLINTERVENTIONREGIONRECOVERY shows billing region intervention recovery details for each participant by region.
BILLSMELTERRATE	BILLSMELTERRATE is standing data, setting out the rates used in smelter reduction calculations.
CONNECTIONPOINT	CONNECTIONPOINT shows all valid connection points and their type. Transmission loss factors are available for all connection points in TRANSMISSIONLOSSFACTOR.
CONNECTIONPOINTDETAILS	<p>CONNECTIONPOINTDETAILS is obsolete, since it was never populated by Participants accessing AEMO's Oracle Interface.</p> <p>CONNECTIONPOINTDETAILS was designed to show relevant details for each connection point including the responsible party, loss factor and relevant MDAs.</p>
CONNECTIONPOINTOPERATINGSTA	CONNECTIONPOINTOPERATINGSTA shows whether a connection point is active or not.
CONTRACTGOVERNOR	CONTRACTGOVERNOR became unused when Ancillary Services Review was implemented in 2001. For more

	<p>details, see Change Notice 126.</p> <p>CONTRACTGOVERNOR shows Governor contract details used in the settlement and dispatch of this service. Note services are dispatched as 6 and 60 raise and lower Frequency Control Ancillary Services (FCAS). Lower and raise 6 and 60 second fields are used in dispatch of services. Deadband and Droop details are used in settlements.</p>
CONTRACTRESERVEFLAG	CONTRACTRESERVEFLAG has never been or will be used. It was to show a period by period flag for regional or market recovery of reserve trading contract amounts.
CONTRACTRESERVETHRESHOLD	CONTRACTRESERVETHRESHOLD shows reserve contract threshold details for enabling, usage and availability thresholds and rates for reserve trader contracts.
CONTRACTRESERVETRADER	CONTRACTRESERVETRADER shows reserve trader contract details. Version numbers do not apply as contracts exist for specified purposes.
CONTRACTUNITLOADING	<p>CONTRACTUNITLOADING became unused when Ancillary Services Review was implemented in 2001. For more details, see Change Notice 126.</p> <p>CONTRACTUNITLOADING shows Unit Loading contract details used in the settlement and dispatch of this service.</p>
CONTRACTUNITUNLOADING	CONTRACTUNITUNLOADING shows Ancillary Service contract data for rapid generator unit unloading.
DAYOFFER	<p>DAYOFFER sets out the participants' daily components of participant bid containing details applying for the whole day (such as prices, daily energy constraint and fast start profiles).</p> <p>To retrieve full bid details, read in conjunction with PEROFFER.</p>
DAYOFFER_D	DAYOFFER_D sets out the participants' daily

	<p>components of participant bid containing just the latest details (such as prices, daily energy constraint and fast start profiles).</p> <p>To retrieve latest bid details, read in conjunction with PEROFFER_D.</p>
DEFAULTDAYOFFER	DEFAULTDAYOFFER shows day-based details of participants' default bids unit for the same day.
DEFAULTOFFERTRK	DEFAULTOFFERTRK shows the file names of default offers submitted for each unit.
DEFAULTPEROFFER	DEFAULTPEROFFER shows half hourly period-based data in the default bid for each Dispatchable Unit, such as period availability, rate of change and band quantities.
DELTAMW	DELTAMW sets out the Frequency Control Ancillary Services (FCAS) requirement to be provided locally within each region and each half-hour period in a market day. Two fields specify Frequency Controlled Ancillary Services requirements to be provided locally for the new regulation ancillary services.
DISPATCHBIDTRK	DISPATCHBIDTRK shows the bid tracking, including the bid version used in each dispatch run for each unit. DISPATCHBIDTRK is the audit trail of the bid actually used in each dispatch.
DISPATCHCASE_OCD	DISPATCHCASE_OCD shows the key data to indicate when an over-constrained dispatch (OCD) re-run actually occurred. One record per over-constrained dispatch interval.
DISPATCHCASESOLUTION_BNC	DISPATCHCASESOLUTION_BNC was discontinued on 30 September 2009. Prior: DISPATCHCASESOLUTION_BNC is the key data to indicate when a binding intra-regional network constraints (BNC) re-run actually occurred.
DISPATCHLOAD_BNC	DISPATCHLOAD_BNC was discontinued on 30 September 2009. Prior: DISPATCHLOAD_BNC gives binding intra-regional network constraints (BNC) re-run

	dispatch results for all scheduled generating units. DISPATCHLOAD_BNC has a similar structure to DISPATCHLOAD but does not repeat input type data (e.g. InitialMW, AGCStatus) since these values are available from DISPATCHLOAD.
DISPATCHTRK	DISPATCHTRK is no longer used. DISPATCHTRK was the cross-reference between each dispatch run and SPD case run. DISPATCHTRK may be available on the InfoServer but not replicated to participant databases as it contains data duplicated in other tables.
FORCEMAJEURE	FORCEMAJEURE used to set out the start and end dates / periods of any force majeure event. FORCEMAJEURE is not used.
FORCEMAJEUREREGION	FORCEMAJEUREREGION used to set out regions impacted by a force majeure event. This table is not used.
GENUNITMTRINPERIOD	GENUNITMTRINPERIOD shows meter reading by period for each generator meter. GENUNITMTRINPERIOD covers generated power flowing into the system. It is used to calculate settlement values.
INTCONTRACT	INTCONTRACT shows intervention contract details. These are specific to each intervention.
INTCONTRACTAMOUNT	INTCONTRACTAMOUNT shows intervention contract amounts.
INTCONTRACTAMOUNTTRK	INTCONTRACTAMOUNTTRK shows the latest valid version of each intervention contract.
INTERCONNMWFLOW	INTERCONNMWFLOW shows Metered Interconnector flow data. INTERCONNMWFLOW shows the meter data provided by Meter Data Providers to MSATS. Despite the name, this view shows metered energy (MWh) and not power flow (MW).

MARKETSUSPENSION	<p>MARKETSUSPENSION is obsolete from 2017 End of Year DM4.27 Release.</p> <p>MARKETSUSPENSION sets out a start and end periods of any market suspension and the reason.</p>
MARKETSUSREGION	<p>MARKETSUSREGION is obsolete from 2017 End of Year DM4.27 Release.</p> <p>MARKETSUSREGION sets out a regions affected by a market suspension.</p>
MAS_CP_CHANGE	MAS_CP_CHANGE records pending changes to the current MAS configuration.
MAS_CP_MASTER	MAS_CP_MASTER shows the current MAS configuration.
METERDATA	METERDATA sets out a meter data for each customer connection point. METERDATA covers market load. Use the field METERRUNNO to match the meter data version for each settlement run.
METERDATA_GEN_DUID	Recorded actual generation of non-scheduled units where SCADA data is available.
METERDATATRK	METERDATATRK records meter data files submitted for each connection point on a daily basis. The same data is provided in METERDATA period by period (i.e. 48 records), whereas METERDATATRK shows one record per day for each file submitted for a connection point.
MTPASA_CASE_SET	<p>MTPASA_CASE_SET is obsolete from 2005 End of Year Release. The RUNTYPE added to the primary key of the detail tables for MTPASA allows for the different types of runs for each case.</p> <p>MTPASA_CASE_SET allows a MT PASA scenario to be linked across runs.</p>
MTPASA_CASESOLUTION	MTPASA_CASESOLUTION is obsolete from 2017 End of Year DM4.27 Release.

	<p>MTPASA_CASESOLUTION holds one record for each entire solution.</p> <p>Change Notice 379 announced the replacement of the MT PASA data model so all MTPASAxXX tables become obsolete, replaced by MTPASA_XXX tables.</p>
MTPASA_CONSTRAINTSOLUTION	<p>MTPASA_CONSTRAINTSOLUTION is obsolete from 2017 End of Year DM4.27 Release.</p> <p>The MTPASA_CONSTRAINTSOLUTION table holds the binding and violated constraint results from the capacity evaluation, including the RHS value.</p> <p>Change Notice 379 announced the replacement of the MT PASA data model so all MTPASAxXX tables become obsolete, replaced by MTPASA_XXX tables.</p>
MTPASA_INTERCONNECTORSOLUTION	<p>MTPASA_INTERCONNECTORSOLUTION is obsolete from 2017 End of Year DM4.27 Release.</p> <p>The MTPASA_INTERCONNECTORSOLUTION table shows the results of the capacity evaluation for Interconnectors, including the calculated limits for the Idcblock within the day.</p> <p>Change Notice 379 announced the replacement of the MT PASA data model so all MTPASAxXX tables become obsolete, replaced by MTPASA_XXX tables (see Change Notices 400, 400a and 400b).</p>
MTPASA_REGIONSOLUTION	<p>MTPASA_CASESOLUTION is obsolete from 2017 End of Year DM4.27 Release.</p> <p>The MTPASA_REGIONSOLUTION table shows the results of the regional capacity, maximum surplus reserve and maximum spare capacity evaluations for each day and Idcblock of the study.</p>

MTPASA_RESERVELIMITSOLUTION	MTPASA_RESERVELIMITSOLUTION is obsolete from 2017 End of Year DM4.27 Release. MT PASA Solution table reporting whether a MT PASA Reserve requirement is binding for each day and LDC block of the run.
MTPASACONSTRAINTSOLUTION_D	MTPASACONSTRAINTSOLUTION_D sets out MT PASA constraint solution results, where constraints are binding.
MTPASAINTERCONNECTORSOLUTION_D	MTPASAINTERCONNECTORSOLUTION_D shows interconnector results for MT PASA, shown region by region.
MTPASAREGIONSOLUTION_D	MTPASAREGIONSOLUTION_D shows region results for MT PASA, showing predicted demand and any capacity limits.
OARTRACK	OARTRACK shows an audit trail of bids for a particular settlement day. Corrupt bids do not update OARTRACK, but are just in OFFERFILETRK.
OFFERFILETRK	OFFERFILETRK shows an audit trail of all bid files submitted containing energy bids, including corrupt bids/rebids.
OFFERGOVDATA	OFFERGOVDATA sets out reoffers of governor (6 and 60 second FCAS) availability.
OFFERULOADINGDATA	OFFERULOADINGDATA shows reoffers of rapid unit loading capability.
OFFERUNLOADINGDATA	OFFERUNLOADINGDATA shows reoffers of rapid unit unloading capability.
PASACASESOLUTION	PASACASESOLUTION sets out ST PASA case listing providing details of each STPASA case run.
PASACONSTRAINTSOLUTION	PASACONSTRAINTSOLUTION records the latest binding STPASA constraint details for each period. For each solution, the latest recalculation for each period

	overwrites the previous entry.
PASAINTERCONNECTORSOLUTION	PASAINTERCONNECTORSOLUTION records ST PASA interconnector solutions for the latest period.
PASAREGIONSOLUTION	PASAREGIONSOLUTION shows the Regional solution for ST PASA showing reserves for each half-hour period. This table (PASAREGIONSOLUTION_D) shows the latest calculated result for each period.
PEROFFER	<p>PEROFFER contains the half-hourly period details of daily bids and rebids, to be used in conjunction with DAYOFFER. These views provide period varying details such as rate of change up (ROCUP), rate of change down (ROCDOWN) and band quantities (BANDAVAIL from 1 to 10).</p> <p>PEROFFER is a child table of DAYOFFER.</p>
PEROFFER_D	<p>PEROFFER_D contains the half-hourly period details of daily bids and rebids, to be used in conjunction with DAYOFFER_D. These views provide period varying details such as rate of change up (ROCUP), rate of change down (ROCDOWN) and band quantities (BANDAVAIL from 1 to 10).</p> <p>PEROFFER_D is a child table of DAYOFFER_D.</p>
PREDISPATCHBIDTRK	PREDISPATCHBIDTRK contains an audit trail of bids used in each predispach run. Where predispach is over 2 days, two bids are listed.
REALLOCATIONDETAILS	REALLOCATIONDETAILS sets out specific reallocation agreements.
REALLOCATIONINTERVALS	REALLOCATIONINTERVALS identifies the the reallocation agreement and provides the corresponding reallocation profiles submitted by the participant and accepted by AEMO

REALLOCATIONS	REALLOCATIONS shows reallocation agreement identifiers with corresponding start and end dates of submitted reallocations as accepted by AEMO.
REGIONFCASRELAXATION_OCD	<p>REGIONFCASRELAXATION_OCD contains details of regional FCAS requirements relaxed in the over-constrained dispatch (OCD) re-run (if there was one).</p> <p>Note: INTERVENTION is not included in REGIONFCASRELAXATION_OCD since the relaxation of the FCAS requirement is the same amount in both intervened and non-intervened cases.</p>
SET_CSP_DEROGATION_AMOUNT	A settlement table for the publication of Snowy CSP derogation amounts.
SET_CSP_SUPPORTDATA_CONSTRAINT	A settlements table for the publication of support data for the Snowy CSP derogation amounts. This table publishes the constraint-level information for each five minute interval in the settlement run
SET_CSP_SUPPORTDATA_ENERGYDIFF	A settlements table for the publication of support data for the Snowy CSP derogation amounts. This table publishes energy differential information for each half-hour interval in the settlement run
SET_CSP_SUPPORTDATA_SUBSTITUTEPRICE	A settlements table for the publication of support data for the Snowy CSP derogation amounts. This table publishes substitution price information for each five minute interval in the settlement run
SETAPCCOMPENSATION	SETAPCCOMPENSATION shows Administered Price Cap (APC) compensation payments for each period.
SETAPCRECOVERY	SETAPCRECOVERY shows reimbursements for Administered Price Cap (APC) to be recovered from participants.
SETFCASRECOVERY	SETFCASRECOVERY shows reimbursements for the

	Frequency Control Ancillary Services compensation.
SETGOVPAYMENT	SETGOVPAYMENT shows specific payment details for Governor services by period.
SETGOVRECOVERY	SETGOVRECOVERY shows reimbursements for the Governor Ancillary Services to be recovered from participants.
SETLULOADPAYMENT	SETLULOADPAYMENT shows specific payment details for rapid unit load services by period.
SETRESERVETRADER	SETRESERVETRADER shows reserve trader details.
STPASA_SYSTEMSOLUTION	STPASA_SYSTEMSOLUTION is obsolete from 2005 End of Year Release. For solution information, see Region solution tables. STPASA_SYSTEMSOLUTION showed the results of the system capacity evaluations for each interval of the study.
STPASA_UNITSOLUTION	STPASA_UNITSOLUTION shows the unit results from the capacity evaluations for each period of the study.

29.2 Diagram: Entities: Historical Tables

These are not shown as the tables are no longer used

29.3 Table: APCCOMP

29.3.1 APCCOMP

Name	APCCOMP
Comment	APCCOMP is to set out Administered Price Cap (APC) compensation periods for a participant.

29.3.2 Description

APCCOMP is public data, and is available to all participants.

Source

APCCOMP is empty until an Administered Price Cap event occurs.

Not in use - never used

29.3.3 Primary Key Columns

Name

APCID

29.3.4 Index Columns

Name

LASTCHANGED

29.3.5 Content

Name	Data Type	Mandatory	Comment
APCID	VARCHAR2(10)	X	APC event identifier.
REGIONID	VARCHAR2(10)		Region

)		
STARTDATE	DATE		Settlement start date
STARTPERIOD	NUMBER(3,0)		Settlement start period (1-48)
ENDDATE	DATE		Settlement end date
ENDPERIOD	NUMBER(3,0)		Settlement end period (1-48)
LASTCHANGED	DATE		Last date and time record changed

29.4 Table: APCCOMPAMOUNT

29.4.1 APCCOMPAMOUNT

Name APCCOMPAMOUNT

Comment APCCOMPAMOUNT shows the Administered Price Cap (APC) compensation amount.

29.4.2 Description

Confidential to participants.

Source

Updated with settlement positive and issued with daily data.

Not in use - never used

29.4.3 Primary Key Columns

Name

APCID

PARTICIPANTID

PERIODID

VERSIONNO

29.4.4 Index Columns

Name

LASTCHANGED

29.4.5 Content

Name	Data Type	Manda	Comment
------	-----------	-------	---------

		tory	
APCID	VARCHAR2(10))	X	APC Identifier
PARTICIPANTID	VARCHAR2(10))	X	Participant identifier
VERSIONNO	NUMBER(3,0)	X	Version number
PERIODID	NUMBER(6,0)	X	Offset from start date and period in APCCOMP table.
AMOUNT	NUMBER(15,5)		Compensation audit.
LASTCHANGED	DATE		Last date and time record changed

29.5 Table: APCCOMPAMOUNTTRK

29.5.1 APCCOMPAMOUNTTRK

Name	APCCOMPAMOUNTTRK
Comment	APCCOMPAMOUNTTRK sets out the relevant Administered Price Cap (APC) period for compensation purposes. Use the APCCOMPAMOUNTTRK table in conjunction with APCAMOUNT.

29.5.2 Description

Public

Source

Updated with settlement posting and issued with daily data.

29.5.3 Primary Key Columns

Name
APCID
VERSIONNO

29.5.4 Index Columns

Name
LASTCHANGED

29.5.5 Content

Name	Data Type	Mandatory	Comment
APCID	VARCHAR2(10)	X	APC Identifier

VERSIONNO	NUMBER(3,0)	X	Version number
AUTHORISED BY	VARCHAR2(10)		Authorised by
AUTHORISED DATE	DATE		Authorised date
LASTCHANGED	DATE		Last date and time record changed

29.6 Table: BILLADJUSTMENTS

29.6.1 BILLADJUSTMENTS

Name BILLADJUSTMENTS

Comment

29.6.2 Description

BILLADJUSTMENTS is confidential, and is available only to the relevant participant.

Source

Ad hoc

29.6.3 Primary Key Columns

Name

ADJBILLRUNNO

ADJCONTRACTYEAR

ADJWEEKNO

CONTRACTYEAR

PARTICIPANTID

WEEKNO

29.6.4 Index Columns

Name

LASTCHANGED

29.6.5 Index Columns

Name

PARTICIPANTID

29.6.6 Content

Name	Data Type	Mandatory	Comment
CONTRACTYEAR	NUMBER(4,0)	X	AEMO Contract Year number starting in week containing 1st January
WEEKNO	NUMBER(3,0)	X	
BILLRUNNO	NUMBER(3,0)		The sequential number of a billing run
PARTICIPANTID	VARCHAR2(10)	X	Unique participant identifier
PARTICIPANTTYPE	VARCHAR2(10)		Participant type Generator/Customer
ADJCONTRACTYEAR	NUMBER(4,0)	X	The contract year of the new revised billing run for this adjustment
ADJWEEKNO	NUMBER(3,0)	X	Week number of the new revised billing run for this adjustment
ADJBILLRUNNO	NUMBER(3,0)	X	Billing run number of the new revised billing run for this adjustment
PREVAMOUNT	NUMBER(16,6)		Prior account
ADJAMOUNT	NUMBER(16,6)		The total bill figure for the new revised billing run
LASTCHANGED	DATE		
LRS	NUMBER(15,5)		

PRS	NUMBER(15,5)		
OFS	NUMBER(15,5)		
IRN	NUMBER(15,5)		Interest rate applying to the new amount
IRP	NUMBER(15,5)		Interest rate applying to the principal amount
INTERESTAMOUNT	NUMBER(15,5)		The total interest payable for this adjustment

29.7 Table: BILLING_CSP_DEROGATION_AMOUNT

29.7.1 BILLING_CSP_DEROGATION_AMOUNT

Name	BILLING_CSP_DEROGATION_AMOUNT
Comment	CSP derogation amounts with respect to participant allocated payment

29.7.2 Description

Source

BILLING_CSP_DEROGATION_AMOUNT is populated by the posting of a billing run.

Volume

An indicative maximum is one record inserted per billing run, or 11 records inserted per week.

29.7.3 Notes

Name	Comment	Value
Visibility	Data in this table is:	Public

29.7.4 Primary Key Columns

Name

AMOUNT_ID

BILLRUNNO

CONTRACTYEAR

PARTICIPANTID

WEEKNO

29.7.5 Index Columns

Name

LASTCHANGED

29.7.6 Content

Name	Data Type	Mandatory	Comment
CONTRACTYEAR	NUMBER(4)	X	Billing contract year
WEEKNO	NUMBER(3)	X	Billing week number
BILLRUNNO	NUMBER(3)	X	Billing run number
PARTICIPANTID	VARCHAR2(10)	X	The participant allocated the payment amount for the derogation
AMOUNT_ID	VARCHAR2(20)	X	Amount identifier represented as a string, from "ta1" through to "ta6" (or "ta8" for a lymmco derogation result)
DEROGATION_AMOUNT	NUMBER(18,8)		Derogation amount associated with the amount identifier
LASTCHANGED	DATE		Last changed date for the record

29.8 Table: BILLINGCPSUM

29.8.1 BILLINGCPSUM

Name BILLINGCPSUM

Comment BILLINGCPSUM shows adjustments for a billing run by participant.

29.8.2 Description

BILLINGCPSUM data is confidential to the relevant participant.

Source

Weekly update with billing run.

29.8.3 Primary Key Columns

Name

BILLRUNNO

CONTRACTYEAR

PARTICIPANTID

PARTICIPANTTYPE

WEEKNO

29.8.4 Index Columns

Name

LASTCHANGED

29.8.5 Index Columns

Name

PARTICIPANTID

29.8.6 Content

Name	Data Type	Mandatory	Comment
CONTRACTYEAR	NUMBER(4,0)	X	AEMO Contract Year number starting in week containing 1st January
WEEKNO	NUMBER(3,0)	X	Week no within the contract year. Week no 1 is the week containing 1st January
BILLRUNNO	NUMBER(3,0)	X	Unique run no within a given contract year and week no
PARTICIPANTID	VARCHAR2(10)	X	Unique participant identifier
PARTICIPANTTYPE	VARCHAR2(10)	X	Participant type Generator/Customer
PREVIOUSAMOUNT	NUMBER(16,6)		Previous amount billed
ADJUSTEDAMOUNT	NUMBER(16,6)		Adjusted amount billed
ADJUSTMENTWEEKNO	NUMBER(3,0)		Week no of adjustment
ADJUSTMENTRUNNO	NUMBER(3,0)		Run no of adjustment
LASTCHANGED	DATE		Last date and time record changed

29.9 Table: BILLINGCUSTEXCESSGEN

29.9.1 BILLINGCUSTEXCESSGEN

Name	BILLINGCUSTEXCESSGEN
Comment	BILLINGCUSTEXCESSGEN shows excess generation payments for each participant cutover.

29.9.2 Description

Source

Obsolete; was updated with relevant settlement runs.

29.9.3 Notes

Name	Comment	Value
Visibility	Data in this table is:	Private

29.9.4 Primary Key Columns

- Name
- BILLRUNNO
- CONTRACTYEAR
- PARTICIPANTID
- PERIODID
- REGIONID
- SETTLEMENTDATE
- WEEKNO

29.9.5 Index Columns

Name

LASTCHANGED

29.9.6 Content

Name	Data Type	Mandatory	Comment
CONTRACTYEAR	NUMBER(4,0)	X	AEMO Contract Year number starting in week containing 1st January
WEEKNO	NUMBER(3,0)	X	Week no within the contract year. Week no 1 is the week containing 1st January
BILLRUNNO	NUMBER(3,0)	X	Unique run no within a given contract year and week no
PARTICIPANTID	VARCHAR2(10)	X	Unique participant identifier
SETTLEMENTDATE	DATE	X	Calendar Settlement Date
PERIODID	NUMBER(3,0)	X	Half hourly trading period that excess generation is for
EXCESSGENPAYMENT	NUMBER(16,6)		Payment by Customer for Excess Generation
LASTCHANGED	DATE		Last date and time record changed
REGIONID	VARCHAR2(10)	X	Region Identifier

29.10 Table: BILLINGEXCESSGEN

29.10.1 BILLINGEXCESSGEN

Name	BILLINGEXCESSGEN
Comment	BILLINGEXCESSGEN shows the excess generation cost by period for each participant.

29.10.2 Description

Source

Obsolete; was updated weekly with each billing run.

29.10.3 Notes

Name	Comment	Value
Visibility	Data in this table is:	Private

29.10.4 Primary Key Columns

- Name
- BILLRUNNO
- CONTRACTYEAR
- PARTICIPANTID
- PERIODID
- REGIONID
- SETTLEMENTDATE
- WEEKNO

29.10.5 Index Columns

Name

LASTCHANGED

29.10.6 Index Columns

Name

PARTICIPANTID

29.10.7 Content

Name	Data Type	Mandatory	Comment
CONTRACTYEAR	NUMBER(4,0)	X	AEMO Contract Year number starting in week containing 1st January
WEEKNO	NUMBER(3,0)	X	Week no within the contract year. Week no 1 is the week containing 1st January
BILLRUNNO	NUMBER(3,0)	X	Unique run no within a given contract year and week no
PARTICIPANTID	VARCHAR2(10)	X	Unique participant identifier
SETTLEMENTDATE	DATE	X	Calendar settlement date record becomes effective
PERIODID	NUMBER(3,0)	X	Settlement interval within the settlement date (1-48) starting at 00:30
EXCESSENERGYCOST	NUMBER(15,5)		Cost of excess energy attributed to this customer

LASTCHANGED	DATE		Last date and time record changed
REGIONID	VARCHAR2(10)	X	Region Identifier

29.11 Table: BILLINGINTERVENTION

29.11.1 BILLINGINTERVENTION

Name	BILLINGINTERVENTION
Comment	BILLINGINTERVENTION shows billing intervention recovery details.

29.11.2 Description

BILLINGINTERVENTION is confidential to the relevant participant.

Source

Updated when reserve trading occurs in a billing run, such as during an Administered Price Cap event. View is empty until such an event occurs.

29.11.3 Notes

Name	Comment	Value
Visibility	Data in this table is:	Private

29.11.4 Primary Key Columns

- Name
- BILLRUNNO
- CONTRACTYEAR
- PARTICIPANTID
- WEEKNO

29.11.5 Index Columns

- Name
- LASTCHANGED

29.11.6 Content

Name	Data Type	Mandatory	Comment
CONTRACTYEAR	NUMBER(4,0)	X	AEMO Contract Year number starting in week containing 1st January
WEEKNO	NUMBER(3,0)	X	Week no within the contract year. Week no 1 is the week containing 1st January
BILLRUNNO	NUMBER(3,0)	X	Unique run no within a given contract year and week no
PARTICIPANTID	VARCHAR2(10)	X	Unique participant identifier
MARKETINTERVENTION	NUMBER(15,5)		Intervention Amounts paid to Generator for Market Recovery for region
TOTALINTERVENTION	NUMBER(15,5)		Total Intervention Amounts paid to Generator
LASTCHANGED	DATE		Last date and time record changed

29.12 Table: BILLINGINTERVENTIONREGION

29.12.1 BILLINGINTERVENTIONREGION

Name	BILLINGINTERVENTIONREGION
Comment	BILLINGINTERVENTIONREGION shows recovery charges for region intervention.

29.12.2 Description

BILLINGINTERVENTIONREGION is confidential to the relevant participant.

Source

BILLINGINTERVENTIONREGION is updated with relevant settlement runs, such as containing an Administered Price Cap. BILLINGINTERVENTIONREGION is empty until such an event occurs.

29.12.3 Notes

Name	Comment	Value
Visibility	Data in this table is:	Private

29.12.4 Primary Key Columns

Name
 BILLRUNNO
 CONTRACTYEAR
 PARTICIPANTID
 REGIONID
 WEEKNO

29.12.5 Index Columns

Name

LASTCHANGED

29.12.6 Content

Name	Data Type	Mandatory	Comment
CONTRACTYEAR	NUMBER(4,0)	X	AEMO Contract Year number starting in week containing 1st January
WEEKNO	NUMBER(3,0)	X	Week no within the contract year. Week no 1 is the week containing 1st January
BILLRUNNO	NUMBER(3,0)	X	Unique run no within a given contract year and week no
PARTICIPANTID	VARCHAR2(10)	X	Unique participant identifier
REGIONID	VARCHAR2(10)	X	Region ID
REGIONINTERVENTION	NUMBER(15,5)		Recovery amount for that region
LASTCHANGED	DATE		Last changed date

29.13 Table: BILLINGRESERVERECOVERY

29.13.1 BILLINGRESERVERECOVERY

Name	BILLINGRESERVERECOVERY
Comment	BILLINGRESERVERECOVERY shows Market Reserve recovery details for each participant in a bill run.

29.13.2 Description

BILLINGRESERVERECOVERY data is Confidential to participant.

Source

BILLINGRESERVERECOVERY updates when reserve trading occurs in a billing run, such as during an Administered Price Cap event. BILLINGRESERVERECOVERY is empty until such an event occurs.

29.13.3 Notes

Name	Comment	Value
Visibility	Data in this table is:	Private

29.13.4 Primary Key Columns

- Name
- BILLRUNNO
- CONTRACTYEAR
- PARTICIPANTID
- WEEKNO

29.13.5 Index Columns

- Name
- LASTCHANGED

29.13.6 Content

Name	Data Type	Mandatory	Comment
CONTRACTYEAR	NUMBER(4,0)	X	AEMO Contract Year number starting in week containing 1st January
WEEKNO	NUMBER(3,0)	X	Week no within the contract year. Week no 1 is the week containing 1st January
BILLRUNNO	NUMBER(3,0)	X	Unique run no within a given contract year and week no
PARTICIPANTID	VARCHAR2(10)	X	Unique participant identifier
MARKETRESERVE	NUMBER(15,5)		Amount Retailer pays for Reserve Trader Contracts with Market Recovery
LASTCHANGED	DATE		Last date and time record changed

29.14 Table: BILLINGRESERVEREGIONRECOVERY

29.14.1 BILLINGRESERVEREGIONRECOVERY

Name	BILLINGRESERVEREGIONRECOVERY
Comment	BILLINGRESERVEREGIONRECOVERY shows Billing Region Reserve region recovery details for each participant (by region).

29.14.2 Description

BILLINGRESERVEREGIONRECOVERY data is confidential to the relevant participant.

Source

BILLINGRESERVEREGIONRECOVERY updates when reserve trading occurs in a billing run, such as during an Administered Price Cap event. View is empty until such an event occurs.

29.14.3 Notes

Name	Comment	Value
Visibility	Data in this table is:	Private

29.14.4 Primary Key Columns

- Name
- BILLRUNNO
- CONTRACTYEAR
- PARTICIPANTID
- REGIONID
- WEEKNO

29.14.5 Index Columns

- Name

LASTCHANGED

29.14.6 Content

Name	Data Type	Mandatory	Comment
CONTRACTYEAR	NUMBER(4,0)	X	AEMO Contract Year number starting in week containing 1st January
WEEKNO	NUMBER(3,0)	X	Week no within the contract year. Week no 1 is the week containing 1st January
BILLRUNNO	NUMBER(3,0)	X	Unique run no within a given contract year and week no
PARTICIPANTID	VARCHAR2(10)	X	Unique participant identifier
REGIONID	VARCHAR2(10)	X	Region Identifier for region recovery.
REGIONRESERVE	NUMBER(15,5)		Amount Retailer pays for Reserve Trader Contracts with Region Recovery
LASTCHANGED	DATE		

29.15 Table: BILLINGRESERVETRADER

29.15.1 BILLINGRESERVETRADER

Name	BILLINGRESERVETRADER
Comment	BILLINGRESERVETRADER shows Billing Market Reserve TRADER payment details to Generators.

29.15.2 Description

BILLINGRESERVETRADER data is Confidential to the relevant participant.

Source

BILLINGRESERVETRADER updates when reserve trading occurs in a billing run, such as during an Administered Price Cap event. View is empty until such an event occurs.

29.15.3 Notes

Name	Comment	Value
Visibility	Data in this table is:	Private

29.15.4 Primary Key Columns

Name

BILLRUNNO

CONTRACTYEAR

PARTICIPANTID

WEEKNO

29.15.5 Index Columns

Name

LASTCHANGED

29.15.6 Content

Name	Data Type	Mandatory	Comment
CONTRACTYEAR	NUMBER(4,0)	X	AEMO Contract Year number starting in week containing 1st January
WEEKNO	NUMBER(3,0)	X	Week no within the contract year. Week no 1 is the week containing 1st January
BILLRUNNO	NUMBER(3,0)	X	Unique run no within a given contract year and week no
PARTICIPANTID	VARCHAR2(10)	X	Unique participant identifier
MARKETRESERVE	NUMBER(15,5)		Reserve Trader Amounts paid to Generator for Market Recovery
TOTALRESERVE	NUMBER(15,5)		Total Reserve Trader Amounts paid to Generator
LASTCHANGED	DATE		Last date and time record changed
TOTALCAPDIFFERENCE	NUMBER(15,5)		

29.16 Table: BILLINGRESERVETRADERREGION

29.16.1 BILLINGRESERVETRADERREGION

Name	BILLINGRESERVETRADERREGION
Comment	BILLINGRESERVETRADERREGION shows Billing Region Reserve Trader payment details.

29.16.2 Description

BILLINGRESERVETRADERREGION data is confidential to the relevant participant.

Source

BILLINGRESERVETRADERREGION updates when reserve trading occurs in a billing run, such as during an Administered Price Cap event. View is empty until such an event occurs.

29.16.3 Notes

Name	Comment	Value
Visibility	Data in this table is:	Private

29.16.4 Primary Key Columns

Name

BILLRUNNO

CONTRACTYEAR

PARTICIPANTID

REGIONID

WEEKNO

29.16.5 Index Columns

Name

LASTCHANGED

29.16.6 Content

Name	Data Type	Mandatory	Comment
CONTRACTYEAR	NUMBER(4,0)	X	AEMO Contract Year number starting in week containing 1st January
WEEKNO	NUMBER(3,0)	X	Week no within the contract year. Week no 1 is the week containing 1st January
BILLRUNNO	NUMBER(3,0)	X	Unique run no within a given contract year and week no
PARTICIPANTID	VARCHAR2(10)	X	Unique participant identifier
REGIONID	VARCHAR2(10)	X	Region Identifier
REGIONRESERVE	NUMBER(15,5)		Reserve Trader Amounts paid to Generator for Region Recovery
LASTCHANGED	DATE		Last date and time record changed

29.17 Table: BILLINTERVENTIONRECOVERY

29.17.1 BILLINTERVENTIONRECOVERY

Name	BILLINTERVENTIONRECOVERY
Comment	BILLINTERVENTIONRECOVERY shows billing market intervention recovery details for each participant.

29.17.2 Description

BILLINTERVENTIONRECOVERY data is confidential to the relevant participant.

Source

BILLINTERVENTIONRECOVERY updates when reserve trading occurs in a billing run, such as during an Administered Price Cap event. View is empty until such an event occurs.

29.17.3 Notes

Name	Comment	Value
Visibility	Data in this table is:	Private

29.17.4 Primary Key Columns

- Name
- BILLRUNNO
- CONTRACTYEAR
- PARTICIPANTID
- WEEKNO

29.17.5 Index Columns

- Name
- LASTCHANGED

29.17.6 Content

Name	Data Type	Mandatory	Comment
CONTRACTYEAR	NUMBER(4,0)	X	AEMO Contract Year number starting in week containing 1st January
WEEKNO	NUMBER(3,0)	X	Week no within the contract year. Week no 1 is the week containing 1st January
BILLRUNNO	NUMBER(3,0)	X	Unique run no within a given contract year and week no
PARTICIPANTID	VARCHAR2(10)	X	Unique participant identifier
MARKETINTERVENTION	NUMBER(15,5)		Amount Retailer pays for Intervention with Market Recovery
LASTCHANGED	DATE		Last date and time record changed

29.18 Table: BILLINTERVENTIONREGIONRECOVERY

29.18.1 BILLINTERVENTIONREGIONRECOVERY

Name	BILLINTERVENTIONREGIONRECOVERY
Comment	BILLINTERVENTIONREGIONRECOVERY shows billing region intervention recovery details for each participant by region.

29.18.2 Description

BILLINTERVENTIONREGIONRECOVERY data is confidential to the relevant participant.

Source

BILLINTERVENTIONREGIONRECOVERY updates when reserve trading occurs in a billing run, such as during an Administered Price Cap event. View is empty until such an event occurs.

29.18.3 Notes

Name	Comment	Value
Visibility	Data in this table is:	Private

29.18.4 Primary Key Columns

- Name
- BILLRUNNO
- CONTRACTYEAR
- PARTICIPANTID
- REGIONID
- WEEKNO

29.18.5 Index Columns

- Name

LASTCHANGED

29.18.6 Content

Name	Data Type	Mandatory	Comment
CONTRACTYEAR	NUMBER(4,0)	X	AEMO Contract Year number starting in week containing 1st January
WEEKNO	NUMBER(3,0)	X	Week no within the contract year. Week no 1 is the week containing 1st January
BILLRUNNO	NUMBER(3,0)	X	Unique run no within a given contract year and week no
PARTICIPANTID	VARCHAR2(10)	X	Unique participant identifier
REGIONID	VARCHAR2(10)	X	Region Identifier
REGIONINTERVENTION	NUMBER(15,5)		Amount retailer pays for intervention with Region Recovery
LASTCHANGED	DATE		Last date and time record changed

29.19 Table: BILLSMELTERRATE

29.19.1 BILLSMELTERRATE

Name	BILLSMELTERRATE
Comment	BILLSMELTERRATE is standing data, setting out the rates used in smelter reduction calculations.

29.19.2 Description

BILLSMELTERRATE is public data, and is available to all participants.

Source

BILLSMELTERRATE updates infrequently, when inserting new annual rates.

Volume

Two records inserted per year

29.19.3 Primary Key Columns

Name
 CONTRACTYEAR
 EFFECTIVEDATE
 VERSIONNO

29.19.4 Index Columns

Name
 LASTCHANGED

29.19.5 Content

Name	Data Type	Mandatory	Comment

EFFECTIVEDATE	DATE	X	Calendar settlement date record becomes effective
VERSIONNO	NUMBER(3,0)	X	Version no of the record for the given effective date
CONTRACTYEAR	NUMBER(22,0)	X	AEMO Contract Year number starting in week containing 1st January
RAR1	NUMBER(6,2)		Smelter rate 1
RAR2	NUMBER(6,2)		Smelter rate 2
AUTHORISEDDATE	DATE		Authorised date
AUTHORISEDBY	VARCHAR2(10)		Who authorised
LASTCHANGED	DATE		Last date and time record changed

29.20 Table: CONNECTIONPOINT

29.20.1 CONNECTIONPOINT

Name CONNECTIONPOINT

Comment CONNECTIONPOINT shows all valid connection points and their type. Transmission loss factors are available for all connection points in TRANSMISSIONLOSSFACTOR.

29.20.2 Description

CONNECTIONPOINT data is confidential to each relevant participant

Source

CONNECTIONPOINT updates for new connection points as required.

29.20.3 Notes

Name	Comment	Value
Visibility	Data in this table is:	Public

29.20.4 Primary Key Columns

Name

CONNECTIONPOINTID

29.20.5 Index Columns

Name

LASTCHANGED

29.20.6 Content

Name	Data Type	Manda	Comment
------	-----------	-------	---------

		tory	
CONNECTIONPOINTID	VARCHAR2(10))	X	Connection Point Identifier
CONNECTIONPOINTNAME	VARCHAR2(80))		Connection point full description
CONNECTIONPOINTTYPE	VARCHAR2(20))		Connection point type. transmission, distribution, station, genunit, or interconnector
ADDRESS1	VARCHAR2(80))		Connection point location
ADDRESS2	VARCHAR2(80))		Connection point location
ADDRESS3	VARCHAR2(80))		Connection point location
ADDRESS4	VARCHAR2(80))		Not Used
CITY	VARCHAR2(40))		City
STATE	VARCHAR2(10))		State of Australia
POSTCODE	VARCHAR2(10))		Post Code
LASTCHANGED	DATE		Last date and time record changed

29.21 Table: CONNECTIONPOINTDETAILS

29.21.1 CONNECTIONPOINTDETAILS

Name	CONNECTIONPOINTDETAILS
Comment	<p>CONNECTIONPOINTDETAILS is obsolete, since it was never populated by Participants accessing AEMO's Oracle Interface.</p> <p>CONNECTIONPOINTDETAILS was designed to show relevant details for each connection point including the responsible party, loss factor and relevant MDAs.</p>

29.21.2 Description

CONNECTIONPOINTDETAILS data is confidential to each participant included in details.

Source

CONNECTIONPOINTDETAILS updates periodically, such as for Transmission Loss Factor (TLF) changes

29.21.3 Notes

Name	Comment	Value
Visibility	Data in this table is:	Public

29.21.4 Primary Key Columns

- Name
- CONNECTIONPOINTID
- EFFECTIVEDATE
- VERSIONNO

29.21.5 Index Columns

- Name

METERDATAPROVIDER

NETWORKSERVICEPROVIDER

FINRESPORGAN

29.21.6 Index Columns

Name

CONNECTIONPOINTID

29.21.7 Index Columns

Name

LASTCHANGED

29.21.8 Content

Name	Data Type	Mandatory	Comment
EFFECTIVEDATE	DATE	X	Effective date of record
VERSIONNO	NUMBER(3,0)	X	Version no of record for given effective date
CONNECTIONPOINTID	VARCHAR2(10))	X	Connection point identifier
REGIONID	VARCHAR2(10))		Region Identifier
TRANSMISSIONCPTID	VARCHAR2(10))		Associated transmission connection point id for a distribution connection point
METERDATAPROVIDER	VARCHAR2(10)		The MDA providing meter data for

)		this connection point
TRANSMISSIONLOSSFACTOR	NUMBER(7,5)		The transmission level loss factor for this connection point
DISTRIBUTIONLOSSFACTOR	NUMBER(7,5)		The distribution level loss factor for a distribution connection point
NETWORKSERVICEPROVIDER	VARCHAR2(10)		The Network Service Provider
FINRESPORGAN	VARCHAR2(10)		Financially responsible organisation
NATIONALMETERINSTALLED	NUMBER(7,5)		National Meter Id
AUTHORISED	VARCHAR2(15)		User authorising record
AUTHORISEDDATE	DATE		Date record authorised
LASTCHANGED	DATE		Last date and time record changed
INUSE	VARCHAR2(1)		Status flag.
LNSP	VARCHAR2(10)		Local Electricity Network Service Provider
MDA	VARCHAR2(10)		Metering Data Agent for connection point.
ROLR	VARCHAR2(10)		Retailer of last resort.
RP	VARCHAR2(10)		Responsible party.
AGGREGATEDDATA	VARCHAR2(1)		Aggregate flag.
VALID_TODATE	DATE		Date of validity.
LR	VARCHAR2(10)		Local Retailer

)		
--	---	--	--

29.22 Table: CONNECTIONPOINTOPERATINGSTA

29.22.1 CONNECTIONPOINTOPERATINGSTA

Name	CONNECTIONPOINTOPERATINGSTA
Comment	CONNECTIONPOINTOPERATINGSTA shows whether a connection point is active or not.

29.22.2 Description

CONNECTIONPOINTOPERATINGSTA data is confidential to each relevant participant.

Source

CONNECTIONPOINTOPERATINGSTA updates periodically with changes in connection point status, such as for Transmission Loss Factor (TLF) changes.

29.22.3 Notes

Name	Comment	Value
Visibility	Data in this table is:	Public

29.22.4 Primary Key Columns

- Name
- CONNECTIONPOINTID
- EFFECTIVEDATE
- VERSIONNO

29.22.5 Index Columns

- Name
- CONNECTIONPOINTID

29.22.6 Index Columns

Name

LASTCHANGED

29.22.7 Content

Name	Data Type	Mandatory	Comment
EFFECTIVEDATE	DATE	X	Effective date of record
VERSIONNO	NUMBER(3,0)	X	
CONNECTIONPOINTID	VARCHAR2(10))	X	Connection point identifier
OPERATINGSTATUS	VARCHAR2(16))		Active or inactive indicator
AUTHORISEDDATE	DATE		Date record authorised
AUTHORISEDBY	VARCHAR2(15))		User authorising record
LASTCHANGED	DATE		Last date and time record changed

29.23 Table: CONTRACTGOVERNOR

29.23.1 CONTRACTGOVERNOR

Name CONTRACTGOVERNOR

Comment CONTRACTGOVERNOR became unused when Ancillary Services Review was implemented in 2001. For more details, see Change Notice 126.

CONTRACTGOVERNOR shows Governor contract details used in the settlement and dispatch of this service. Note services are dispatched as 6 and 60 raise and lower Frequency Control Ancillary Services (FCAS). Lower and raise 6 and 60 second fields are used in dispatch of services. Deadband and Droop details are used in settlements.

29.23.2 Description

Confidential to participant

Source

Not in Use - discontinued 30/09/2001: was updated only where there was a contract variation.

29.23.3 Primary Key Columns

Name

CONTRACTID

VERSIONNO

29.23.4 Index Columns

Name

LASTCHANGED

29.23.5 Index Columns

Name

PARTICIPANTID

29.23.6 Content

Name	Data Type	Mandatory	Comment
CONTRACTID	VARCHAR2(10)	X	Contract Identifier
VERSIONNO	NUMBER(3,0)	X	Contract Version No.
STARTDATE	DATE		Starting Date of Contract
ENDDATE	DATE		Termination Date of Contract
PARTICIPANTID	VARCHAR2(10)		Unique participant identifier
DUID	VARCHAR2(10)		Dispatchable Unit ID
CCPRICE	NUMBER(10,2)		Compensation Cap
LOWER60SECBREAKPOINT	NUMBER(9,6)		Limit Equation Lower 60 Second Breakpoint MW
LOWER60SECMAX	NUMBER(9,6)		Limit Equation Lower 60 Second Maximum MW
LOWER6SECBREAKPOINT	NUMBER(9,6)		Limit Equation Lower 6 Second Breakpoint MW
LOWER6SECMAX	NUMBER(9,6)		Limit Equation Lower 6 Second Maximum MW
RAISE60SECBREAKPOINT	NUMBER(9,6)		Limit Equation Raise 60 Second Breakpoint MW

RAISE60SECCAPACITY	NUMBER(9,6)		Limit Equation Raise 60 Second Capacity MW
RAISE60SECMAX	NUMBER(9,6)		Limit Equation Raise 60 Second Maximum MW
RAISE6SECBREAKPOINT	NUMBER(9,6)		Limit Equation Raise 6 Second Breakpoint MW
RAISE6SECCAPACITY	NUMBER(9,6)		Limit Equation Raise 6 Second Capacity MW
RAISE6SECMAX	NUMBER(9,6)		Limit Equation Raise 6 Second Maximum MW
PRICE6SECRAISEMANDATORY	NUMBER(16,6)		Not used
QUANT6SECRAISEMANDATORY	NUMBER(16,6)		Not used
PRICE6SECRAISECONTRACT	NUMBER(16,6)		Contract Price for 6 Second Raise
QUANT6SECRAISECONTRACT	NUMBER(16,6)		Contract Quantity for 6 Second Raise
PRICE60SECRAISEMANDATORY	NUMBER(16,6)		Not used
QUANT60SECRAISEMANDATORY	NUMBER(16,6)		Not used
PRICE60SECRAISECONTRACT	NUMBER(16,6)		Contract Price for 60 Second Raise
QUANT60SECRAISECONTRACT	NUMBER(16,6)		Contract Quantity for 60 Second Raise
PRICE6SECLOWERMANDATORY	NUMBER(16,6)		Not used

QUANT6SECLOWERMANDATORY	NUMBER(16,6)		Not used
PRICE6SECLOWERCONTRACT	NUMBER(16,6)		Contract Price for 6 Second Lower
QUANT6SECLOWERCONTRACT	NUMBER(16,6)		Contract Quantity for 6 Second Lower
PRICE60SECLOWERMANDATORY	NUMBER(16,6)		Not used
QUANT60SECLOWERMANDATORY	NUMBER(16,6)		Not used
PRICE60SECLOWERCONTRACT	NUMBER(16,6)		Contract Price for 60 Second Lower
QUANT60SECLOWERCONTRACT	NUMBER(16,6)		Contract Quantity for 60 Second Lower
DEADBANDUP	NUMBER(4,2)		Raise Deadband
DEADBANDDOWN	NUMBER(4,2)		Lower Deadband
DROOP6SECRAISEBREAKPOINT	NUMBER(9,6)		Droop Equation Raise 6 Second Breakpoint
DROOP6SECRAISECAPACITY	NUMBER(9,6)		Droop Equation Raise 6 Second Capacity
DROOP6SECRAISEMAX	NUMBER(9,6)		Droop Equation Raise 6 Second Maximum
DROOP60SECRAISEBREAKPOINT	NUMBER(9,6)		Droop Equation Raise 60 Second Breakpoint
DROOP60SECRAISECAPACITY	NUMBER(9,6)		Droop Equation Raise 60 Second Capacity
DROOP60SECRAISEMAX	NUMBER(9,6)		Droop Equation Raise 60 Second Maximum

DROOP6SECLOWERBREAK POINT	NUMBER(9,6)		Droop Equation Lower 6 Second Breakpoint
DROOP6SECLOWERMAX	NUMBER(9,6)		Droop Equation Lower 6 Second Maximum
DROOP60SECLOWERBREA KPOINT	NUMBER(9,6)		Droop Equation Lower 60 Second Breakpoint
DROOP60SECLOWERMAX	NUMBER(9,6)		Droop Equation Lower 60 Second Maximum
AUTHORISED BY	VARCHAR2(15)		User Name
AUTHORISED DATE	DATE		Date Contract was authorised
LASTCHANGED	DATE		Last date and time record changed

29.24 Table: CONTRACTRESERVEFLAG

29.24.1 CONTRACTRESERVEFLAG

Name CONTRACTRESERVEFLAG

Comment CONTRACTRESERVEFLAG has never been or will be used. It was to show a period by period flag for regional or market recovery of reserve trading contract amounts.

29.24.2 Description

CONTRACTRESERVEFLAG data is confidential to the relevant participant.

Source

CONTRACTRESERVEFLAG updates when we want to enter a reserve contract.

29.24.3 Primary Key Columns

Name

CONTRACTID

PERIODID

VERSIONNO

29.24.4 Index Columns

Name

LASTCHANGED

29.24.5 Content

Name	Data Type	Mandatory	Comment
CONTRACTID	VARCHAR2(10)	X	Reserve Trader Contract Identifier

)		
VERSIONNO	NUMBER(3,0)	X	Reserve Trader Contract Version
PERIODID	NUMBER(3,0)	X	Calendar settlement date period identifier, i.e. period 1 is 00:30
RCF	CHAR(1)		Reserve Recovery Flag
LASTCHANGED	DATE		Last date and time record changed

29.25 Table: CONTRACTRESERVETHRESHOLD

29.25.1 CONTRACTRESERVETHRESHOLD

Name	CONTRACTRESERVETHRESHOLD
Comment	CONTRACTRESERVETHRESHOLD shows reserve contract threshold details for enabling, usage and availability thresholds and rates for reserve trader contracts.

29.25.2 Description

CONTRACTRESERVETHRESHOLD data is confidential to the relevant participant.

Source

CONTRACTRESERVETHRESHOLD updates when reserve contracts are first entered or updated.

29.25.3 Primary Key Columns

Name
 CONTRACTID
 VERSIONNO

29.25.4 Index Columns

Name
 LASTCHANGED

29.25.5 Content

Name	Data Type	Mandatory	Comment
CONTRACTID	VARCHAR2(10)	X	Contract Identifier

VERSIONNO	NUMBER(3,0)	X	Contract Version
CRA	NUMBER(16,6)		Availability Rate \$
CRE	NUMBER(16,6)		Enabling Rate \$
CRU	NUMBER(16,6)		Usage Rate \$
CTA	NUMBER(16,6)		Availability Threshold MW/h
CTE	NUMBER(16,6)		Enabling Threshold MW/h
CTU	NUMBER(16,6)		Usage Threshold MW/h
AUTHORISED BY	VARCHAR2(15)		User name
AUTHORISED DATE	DATE		Date contract was authorised
LAST CHANGED	DATE		Last date and time record changed

29.26 Table: CONTRACTRESERVETRADER

29.26.1 CONTRACTRESERVETRADER

Name CONTRACTRESERVETRADER

Comment CONTRACTRESERVETRADER shows reserve trader contract details. Version numbers do not apply as contracts exist for specified purposes.

29.26.2 Description

CONTRACTRESERVETRADER data is confidential to the relevant participant.

Source

CONTRACTRESERVETRADER updates when reserve trader activities occur.

29.26.3 Primary Key Columns

Name

CONTRACTID

29.26.4 Index Columns

Name

LASTCHANGED

29.26.5 Content

Name	Data Type	Mandatory	Comment
CONTRACTID	VARCHAR2(10)	X	Reserve Trader Contract Identifier
DUID	VARCHAR2(10)		Dispatchable Unit ID

STARTDATE	DATE		Starting Date of Contract
ENDDATE	DATE		Terminate Date of contract
STARTPERIOD	NUMBER(3,0)		Starting period of contract
ENDPERIOD	NUMBER(3,0)		Terminate period of contract based on calendar date.
DEREGISTRATIONDATE	DATE		De-registration date of contract; Not Used
DEREGISTRATIONPERIOD	NUMBER(3,0)		De-registration period of contract; Not Used
PARTICIPANTID	VARCHAR2(10)		Unique participant identifier
LASTCHANGED	DATE		Last date and time record changed
REGIONID	VARCHAR2(10)		Region Identifier

29.27 Table: CONTRACTUNITLOADING

29.27.1 CONTRACTUNITLOADING

Name CONTRACTUNITLOADING

Comment CONTRACTUNITLOADING became unused when Ancillary Services Review was implemented in 2001. For more details, see Change Notice 126.

CONTRACTUNITLOADING shows Unit Loading contract details used in the settlement and dispatch of this service.

29.27.2 Description

CONTRACTUNITLOADING is confidential to participants.

Source

CONTRACTUNITLOADING is not in Use - discontinued 30/09/2001; was updated only where there was a contract variation.

29.27.3 Primary Key Columns

Name

CONTRACTID

VERSIONNO

29.27.4 Index Columns

Name

LASTCHANGED

29.27.5 Index Columns

Name

PARTICIPANTID

29.27.6 Content

Name	Data Type	Mandatory	Comment
CONTRACTID	VARCHAR2(10)	X	Contract Identifier
VERSIONNO	NUMBER(3,0)	X	Contract Version No.
STARTDATE	DATE		Starting Date of Contract
ENDDATE	DATE		Termination Date of Contract
PARTICIPANTID	VARCHAR2(10)		Unique participant identifier
DUID	VARCHAR2(10)		Dispatchable Unit ID
RPRICE	NUMBER(10,2)		Enabling Price
SUPRICE	NUMBER(10,2)		Usage Price
CCPRICE	NUMBER(10,2)		Compensation Cap
ACR	NUMBER(10,2)		Available Control Range
BS	NUMBER(10,2)		Block Size of Unit
PP	NUMBER(10,2)		Estimated Price for supply
EU	NUMBER(10,2)		Estimated Power consumption of unit when enabled for RGUL
AUTHORISED BY	VARCHAR2(15)		User Name
AUTHORISED DATE	DATE		Date Contract was authorised
LASTCHANGED	DATE		Last date and time record changed

29.28 Table: CONTRACTUNITUNLOADING

29.28.1 CONTRACTUNITUNLOADING

Name	CONTRACTUNITUNLOADING
Comment	CONTRACTUNITUNLOADING shows Ancillary Service contract data for rapid generator unit unloading.

29.28.2 Description

CONTRACTUNITUNLOADING data is confidential to relevant participants.

Source

CONTRACTUNITUNLOADING updates only where there is a contract variation.

29.28.3 Primary Key Columns

Name
CONTRACTID
VERSIONNO

29.28.4 Index Columns

Name
PARTICIPANTID

29.28.5 Index Columns

Name
LASTCHANGED

29.28.6 Content

Name	Data Type	Mandatory	Comment
CONTRACTID	VARCHAR2(10)	X	Contract Identifier
VERSIONNO	NUMBER(3,0)	X	Contract Version No.
STARTDATE	DATE		Starting Date of Contract
ENDDATE	DATE		Termination Date of Contract
PARTICIPANTID	VARCHAR2(10)		Unique participant identifier
DUID	VARCHAR2(10)		Dispatchable Unit ID
RPRICE	NUMBER(10,2)		Enabling Price
SUPRICE	NUMBER(10,2)		Usage Price
CCPRICE	NUMBER(10,2)		Compensation Cap
AUTHORISED BY	VARCHAR2(15)		User Name
AUTHORISED DATE	DATE		Date Contract was Authorised
LASTCHANGED	DATE		Last date and time record changed

29.29 Table: DAYOFFER

29.29.1 DAYOFFER

Name DAYOFFER

Comment DAYOFFER sets out the participants' daily components of participant bid containing details applying for the whole day (such as prices, daily energy constraint and fast start profiles).

To retrieve full bid details, read in conjunction with PEROFFER.

29.29.2 Description

DAYOFFER data is confidential to the submitting participant until made public after 4am the next day. The table DAYOFFER_D is quite distinct, with same field names (see DAYOFFER_D).

29.29.3 Primary Key Columns

Name

DUID

OFFERDATE

SETTLEMENTDATE

VERSIONNO

29.29.4 Index Columns

Name

LASTCHANGED

29.29.5 Index Columns

Name

DUID

LASTCHANGED

29.29.6 Content

Name	Data Type	Mandatory	Comment
SETTLEMENTDATE	DATE	X	Market date starting at 04:00am
DUID	VARCHAR2(10)	X	Dispatchable unit identifier
VERSIONNO	NUMBER(3,0)	X	Version no. for given offer date
OFFERDATE	DATE	X	Offer date of data
SELFCOMMITFLAG	VARCHAR2(1)		Not used
DAILYENERGYCONSTRAINT	NUMBER(12,6)		Maximum energy available from Energy Constrained Plant.
ENTRYTYPE	VARCHAR2(20)		Daily or Rebid
CONTINGENCYPRICE	NUMBER(9,2)		Not used
REBIDEXPLANATION	VARCHAR2(64)		Explanation for all rebids and inflexibilities
BANDQUANTISATIONID	NUMBER(2,0)		Not used
PRICEBAND1	NUMBER(9,2)		Price for Availability Band 1
PRICEBAND2	NUMBER(9,2)		Price for Availability Band 2
PRICEBAND3	NUMBER(9,2)		Price for Availability Band 3
PRICEBAND4	NUMBER(9,2)		Price for Availability Band 4
PRICEBAND5	NUMBER(9,2)		Price for Availability Band 5
PRICEBAND6	NUMBER(9,2)		Price for Availability Band 6

PRICEBAND7	NUMBER(9,2)		Price for Availability Band 7
PRICEBAND8	NUMBER(9,2)		Price for Availability Band 8
PRICEBAND9	NUMBER(9,2)		Price for Availability Band 9
PRICEBAND10	NUMBER(9,2)		Price for Availability Band 10
MAXRAMPUP	NUMBER(9,2)		Not used
MAXRAMPDOWN	NUMBER(9,2)		Not used
MINIMUMLOAD	NUMBER(6,0)		Minimum MW load fast start plant in MW
T1	NUMBER(6,0)		Time to synchronise in minutes
T2	NUMBER(6,0)		Time to minimum load in minutes
T3	NUMBER(6,0)		Time at minimum load in minutes
T4	NUMBER(6,0)		Time to shutdown in minutes
NORMALSTATUS	VARCHAR2(3)		ON/OFF for loads
LASTCHANGED	DATE		Last date and time record changed
MR_FACTOR	NUMBER(16,6)		Mandatory Restriction Price Scaling Factor

29.30 Table: DAYOFFER_D

29.30.1 DAYOFFER_D

Name DAYOFFER_D

Comment DAYOFFER_D sets out the participants' daily components of participant bid containing just the latest details (such as prices, daily energy constraint and fast start profiles).

To retrieve latest bid details, read in conjunction with PEROFFER_D.

29.30.2 Description

Not in Use - discontinued 16/11/2003

DAYOFFER data was confidential to the submitting participant until made public after 4am the next day.

The table DAYOFFER is quite distinct, with same field names (see DAYOFFER).

29.30.3 Primary Key Columns

Name

DUID

OFFERDATE

SETTLEMENTDATE

VERSIONNO

29.30.4 Index Columns

Name

LASTCHANGED

29.30.5 Index Columns

Name

DUID

LASTCHANGED

29.30.6 Content

Name	Data Type	Mandatory	Comment
SETTLEMENTDATE	DATE	X	Market date starting at 04:00am
DUID	VARCHAR2(10)	X	Dispatchable unit identifier
VERSIONNO	NUMBER(3,0)	X	Version no. for given offer date
OFFERDATE	DATE	X	Offer date of data
SELFCOMMITFLAG	VARCHAR2(1)		Not used
DAILYENERGYCONSTRAINT	NUMBER(12,6)		Maximum energy available from Energy Constrained Plant.
ENTRYTYPE	VARCHAR2(20)		Daily or Rebid
CONTINGENCYPRICE	NUMBER(9,2)		Not used
REBIDEXPLANATION	VARCHAR2(64)		Explanation for all rebids and inflexibilities
BANDQUANTISATIONID	NUMBER(2,0)		Not used
PRICEBAND1	NUMBER(9,2)		Price for Availability Band 1
PRICEBAND2	NUMBER(9,2)		Price for Availability Band 2
PRICEBAND3	NUMBER(9,2)		Price for Availability Band 3
PRICEBAND4	NUMBER(9,2)		Price for Availability Band 4
PRICEBAND5	NUMBER(9,2)		Price for Availability Band 5

PRICEBAND6	NUMBER(9,2)		Price for Availability Band 6
PRICEBAND7	NUMBER(9,2)		Price for Availability Band 7
PRICEBAND8	NUMBER(9,2)		Price for Availability Band 8
PRICEBAND9	NUMBER(9,2)		Price for Availability Band 9
PRICEBAND10	NUMBER(9,2)		Price for Availability Band 10
MAXRAMPUP	NUMBER(9,2)		Not used
MAXRAMPDOWN	NUMBER(9,2)		Not used
MINIMUMLOAD	NUMBER(6,0)		Minimum MW load fast start plant in MW
T1	NUMBER(6,0)		Time to synchronise in minutes
T2	NUMBER(6,0)		Time to minimum load in minutes
T3	NUMBER(6,0)		Time at minimum load in minutes
T4	NUMBER(6,0)		Time to shutdown in minutes
NORMALSTATUS	VARCHAR2(3)		ON/OFF for loads
LASTCHANGED	DATE		Last date and time record changed
MR_FACTOR	NUMBER(6,0)		Mandatory Restriction Price Scaling Factor

29.31 Table: DEFAULTDAYOFFER

29.31.1 DEFAULTDAYOFFER

Name DEFAULTDAYOFFER

Comment DEFAULTDAYOFFER shows day-based details of participants' default bids unit for the same day.

29.31.2 Description

Source

Obsolete; was updated only when participant changed their default bid.

29.31.3 Primary Key Columns

Name

DUID

SETTLEMENTDATE

VERSIONNO

29.31.4 Index Columns

Name

LASTCHANGED

29.31.5 Content

Name	Data Type	Mandatory	Comment
SETTLEMENTDATE	DATE	X	Market date starting at 04:30
DUID	VARCHAR2(10)	X	Dispatchable unit Identifier

)		
VERSIONNO	NUMBER(3,0)	X	Version No for given offer date
SELFCOMMITFLAG	VARCHAR2(1)		Not used
DAILYENERGYCONSTRAINT	NUMBER(12,6)		Maximum energy available from Energy Constrained Plant.
ENTRYTYPE	VARCHAR2(20)		Daily or Rebid
CONTINGENCYPRICE	NUMBER(9,2)		Not used
REBIDEXPLANATION	VARCHAR2(64)		Explanation for all rebids and inflexibilities
BANDQUANTISATIONID	NUMBER(2,0)		Not used
PRICEBAND1	NUMBER(9,2)		Price for Availability Band 1
PRICEBAND2	NUMBER(9,2)		Price for Availability Band 2
PRICEBAND3	NUMBER(9,2)		Price for Availability Band 3
PRICEBAND4	NUMBER(9,2)		Price for Availability Band 4
PRICEBAND5	NUMBER(9,2)		Price for Availability Band 5
PRICEBAND6	NUMBER(9,2)		Price for Availability Band 6
PRICEBAND7	NUMBER(9,2)		Price for Availability Band 7
PRICEBAND8	NUMBER(9,2)		Price for Availability Band 8
PRICEBAND9	NUMBER(9,2)		Price for Availability Band 9
PRICEBAND10	NUMBER(9,2)		Price for Availability Band 10
MAXRAMPUP	NUMBER(9,2)		Not used
MAXRAMPDOWN	NUMBER(9,2)		Not used
MINIMUMLOAD	NUMBER(6,0)		Minimum stable load

T1	NUMBER(6,0)		Time to synchronise in minutes
T2	NUMBER(6,0)		Time to minimum load in minutes
T3	NUMBER(6,0)		Time at minimum load in minutes
T4	NUMBER(6,0)		Time to shut down in minutes
LASTCHANGED	DATE		Last date and time record changed

29.32 Table: DEFAULTOFFERTRK

29.32.1 DEFAULTOFFERTRK

Name DEFAULTOFFERTRK

Comment DEFAULTOFFERTRK shows the file names of default offers submitted for each unit.

29.32.2 Description

Source

Obsolete; was updated only when participant changed their default bid.

29.32.3 Primary Key Columns

Name

DUID

EFFECTIVEDATE

VERSIONNO

29.32.4 Index Columns

Name

LASTCHANGED

29.32.5 Content

Name	Data Type	Mandatory	Comment
DUID	VARCHAR2(10)	X	Dispatchable Unit Identifier

EFFECTIVEDATE	DATE	X	Market date default offer file is effective
VERSIONNO	NUMBER(3,0)	X	Version no of file for this date
FILENAME	VARCHAR2(40))		Load File identifier
AUTHORISED BY	VARCHAR2(15))		User authorising record
AUTHORISED DATE	DATE		Date record authorised
LASTCHANGED	DATE		Last date and time record changed

29.33 Table: DEFAULTPEROFFER

29.33.1 DEFAULTPEROFFER

Name DEFAULTPEROFFER

Comment DEFAULTPEROFFER shows half hourly period-based data in the default bid for each Dispatchable Unit, such as period availability, rate of change and band quantities.

29.33.2 Description

Source

Obsolete; was updated only when participant changes their default bid.

29.33.3 Primary Key Columns

Name

DUID

PERIODID

SETTLEMENTDATE

VERSIONNO

29.33.4 Index Columns

Name

LASTCHANGED

29.33.5 Content

Name	Data Type	Mandatory	Comment
------	-----------	-----------	---------

SETTLEMENTDATE	DATE	X	Market date starting at 04:30
DUID	VARCHAR2(10)	X	Dispatchable Unit Identifier
PERIODID	NUMBER(3,0)	X	Market data. Trading Interval number
VERSIONNO	NUMBER(3,0)	X	Version no of the offer file.
SELFDISPATCH	NUMBER(9,6)		Not used
MAXAVAIL	NUMBER(12,6)		Maximum planned availability MW
FIXEDLOAD	NUMBER(9,6)		Fixed unit output MW. A value of zero means no fixed load so the unit is dispatched according to bid and market (rather than zero fixed load)
ROCU	NUMBER(6,0)		Rate of change up MW/min
ROCDOWN	NUMBER(6,0)		Rate of change down MW/min
LASTCHANGED	DATE		Last date and time record changed
BANDAVAIL1	NUMBER(6,0)		Availability at price band 1
BANDAVAIL2	NUMBER(6,0)		Availability at price band 2
BANDAVAIL3	NUMBER(6,0)		Availability at price band 3
BANDAVAIL4	NUMBER(6,0)		Availability at price band 4
BANDAVAIL5	NUMBER(6,0)		Availability at price band 5
BANDAVAIL6	NUMBER(6,0)		Availability at price band 6
BANDAVAIL7	NUMBER(6,0)		Availability at price band 7
BANDAVAIL8	NUMBER(6,0)		Availability at price band 8
BANDAVAIL9	NUMBER(6,0)		Availability at price band 9

BANDAVAIL10	NUMBER(6,0)		Availability at price band 10
PASAAVAILABILITY	NUMBER(12,0)		The physical plant capability including any capability potentially available within 24 hours.

29.34 Table: DELTAMW

29.34.1 DELTAMW

Name	DELTAMW
Comment	DELTAMW sets out the Frequency Control Ancillary Services (FCAS) requirement to be provided locally within each region and each half-hour period in a market day. Two fields specify Frequency Controlled Ancillary Services requirements to be provided locally for the new regulation ancillary services.

29.34.2 Description

Change Notice 324 (for the FCAS Constraint enhancements project) means that Dispatch no longer utilises the static FCAS requirements defined in the DELTAMW and RESERVE tables. These tables are replaced with constraint data as a source of FCAS requirements.

The name of the table derives from the now obsolete delta MW for participant factors in Queensland.

Source

DELTAMW updates result from action by operational control staff, generally once a day.

Not in Use - discontinued 16/11/2003

29.34.3 Primary Key Columns

Name
PERIODID
REGIONID
SETTLEMENTDATE
VERSIONNO

29.34.4 Index Columns

Name
LASTCHANGED

29.34.5 Content

Name	Data Type	Mandatory	Comment
SETTLEMENTDATE	DATE	X	Market date starting at 04:30
VERSIONNO	NUMBER(3,0)	X	Version No of record for this date
REGIONID	VARCHAR2(10)	X	Differentiates this region from all other regions
PERIODID	NUMBER(2,0)	X	Market trading interval from 1 to 48 starting at 04:30
DELTAMW	NUMBER(6,0)		Not Used
LOWER5MIN	NUMBER(6,0)		Lower 5 min local share requirement
LOWER60SEC	NUMBER(6,0)		Lower 60 sec local share requirement
LOWER6SEC	NUMBER(6,0)		Lower 6 sec local share requirement
RAISE5MIN	NUMBER(6,0)		Raise 5 minute local share requirement
RAISE60SEC	NUMBER(6,0)		Raise 60 sec local share requirement
RAISE6SEC	NUMBER(6,0)		Raise 6 sec local share requirement
LASTCHANGED	DATE		Last date and time record changed
RAISEREG	NUMBER(6,0)		Raise Regulation local share requirement
LOWERREG	NUMBER(6,0)		Lower Regulation local share requirement

29.35 Table: DISPATCHBIDTRK

29.35.1 DISPATCHBIDTRK

Name DISPATCHBIDTRK

Comment DISPATCHBIDTRK shows the bid tracking, including the bid version used in each dispatch run for each unit. DISPATCHBIDTRK is the audit trail of the bid actually used in each dispatch.

29.35.2 Primary Key Columns

Name

DUID

OFFEREFFECTIVEDATE

OFFERVERSIONNO

RUNNO

SETTLEMENTDATE

29.35.3 Index Columns

Name

LASTCHANGED

29.35.4 Index Columns

Name

DUID

LASTCHANGED

29.35.5 Content

Name	Data Type	Mandatory	Comment
SETTLEMENTDATE	DATE	X	Market date starting at 04:05
RUNNO	NUMBER(3,0)	X	Dispatch run no from 1 to 288 (as per bid)
OFFEREFFECTIVEDATE	DATE	X	Effective date of offer used
OFFERVERSIONNO	NUMBER(3,0)	X	Version no of offer used
DUID	VARCHAR2(10)	X	Dispatchable unit identifier
BIDTYPE	VARCHAR2(10)		Bid type (daily, default or rebid)
LASTCHANGED	DATE		Last date and time record changed

29.36 Table: DISPATCHCASE_OCD

29.36.1 DISPATCHCASE_OCD

Name	DISPATCHCASE_OCD
Comment	DISPATCHCASE_OCD shows the key data to indicate when an over-constrained dispatch (OCD) re-run actually occurred. One record per over-constrained dispatch interval.

29.36.2 Description

The DISPATCHCASE_OCD data is public.

Source

The occurrences of Over-constrained dispatch (OCD) or binding intra-regional network constraints (BNC) re-runs are ad hoc, with significant dependencies on the configuration or events in the physical power system. Potentially updated every 5 minutes.

Volume

Rows per day: ~2

Mb per month: <1

The estimates on the number of rows are based on a 1% occurrence rate for OCD runs.

Note

Due to the close dependency with the dispatch process, the OCD and BNC data models use a “CaseSolution” key table in the same manner as the DISPATCHCASESOLUTION table.

29.36.3 Notes

Name	Comment	Value
Visibility	Data in this table is:	Public

29.36.4 Primary Key Columns

- Name
- RUNNO
- SETTLEMENTDATE

29.36.5 Index Columns

Name

LASTCHANGED

29.36.6 Content

Name	Data Type	Mandatory	Comment
SETTLEMENTDATE	DATE	X	End date and time of the dispatch interval
RUNNO	NUMBER(3,0)	X	Dispatch run no; always 1
LASTCHANGED	DATE		Last date and time record changed

29.37 Table: DISPATCHCASESOLUTION_BNC

29.37.1 DISPATCHCASESOLUTION_BNC

Name	DISPATCHCASESOLUTION_BNC
Comment	DISPATCHCASESOLUTION_BNC was discontinued on 30 September 2009. Prior: DISPATCHCASESOLUTION_BNC is the key data to indicate when a binding intra-regional network constraints (BNC) re-run actually occurred.

29.37.2 Description

DISPATCHCASESOLUTION_BNC was discontinued on 30 September 2009.

In accordance with the "Arrangements for Managing Risks Associated with Transmission Network Congestion" set of rule changes the Dispatch Binding Network Constraints re-run was discontinued on September 30, 2009.

Source

The occurrences of Over-constrained dispatch (OCD) or binding intra-regional network constraints (BNC) re-runs are ad hoc, with significant dependencies on the configuration or events in the physical power system. Potentially updated every 5 minutes.

Volume

Rows per day: ~72

Mb per month: 25% of DISPATCHCASESOLUTION

The estimates on the number of rows are based on a 25% occurrence rate for BNC runs.

Note

Due to the close dependency with the dispatch process, the OCD and BNC data models use a "CaseSolution" key table in the same manner as DISPATCHCASESOLUTION.

29.37.3 Notes

Name	Comment	Value
Visibility	Data in this table is:	Public

29.37.4 Primary Key Columns

Name

INTERVENTION

RUNNO

SETTLEMENTDATE

29.37.5 Index Columns

Name

LASTCHANGED

29.37.6 Content

Name	Data Type	Mandatory	Comment
SETTLEMENTDATE	DATE	X	End date and time of the dispatch interval
RUNNO	NUMBER(3,0)	X	Dispatch run no; always 1
INTERVENTION	NUMBER(2,0)	X	Manual intervention flag
CASESUBTYPE	VARCHAR2(3)		always BNC
SOLUTIONSTATUS	NUMBER(2,0)		If non-zero indicated one of the following conditions: * 1 = Supply Scarcity, Excess generation or constraint violations * X = Model failure
SPDVERSION	NUMBER(10,3)		Current version of SPD
STARTPERIOD	VARCHAR2(20)		Period identifier of first interval of the case (yyyymmddppp)
NONPHYSICALLOSSES	NUMBER(1,0)		Non-Physical Losses algorithm invoked occurred during this run

TOTALOBJECTIVE	NUMBER(27,10)		The Objective function from the LP
TOTALAREAGENVIOLATION	NUMBER(15,5)		Total Region Demand violations
TOTALINTERCONNECTORVIOLATION	NUMBER(15,5)		Total interconnector violations
TOTALGENERICVIOLATION	NUMBER(15,5)		Total generic constraint violations
TOTALRAMPRATEVIOLATION	NUMBER(15,5)		Total ramp rate violations
TOTALUNITMWCAPACITYVIOLATION	NUMBER(15,5)		Total unit capacity violations
TOTAL5MINVIOLATION	NUMBER(15,5)		Total of 5 minute ancillary service region violations
TOTALREGVIOLATION	NUMBER(15,5)		Total of Regulation ancillary service region violations
TOTAL6SECVIOLATION	NUMBER(15,5)		Total of 6 second ancillary service region violations
TOTAL60SECVIOLATION	NUMBER(15,5)		Total of 60 second ancillary service region violations
TOTALENERGYCONSTRVIOLATION	NUMBER(15,5)		
TOTALENERGYOFFERVIOLATION	NUMBER(15,5)		Total of unit summated offer band violations
TOTALASPROFILEVIOLATION	NUMBER(15,5)		Total of ancillary service trader profile violations
TOTALFASTSTARTVIOLATION	NUMBER(15,5)		Total of fast start trader profile violations
LASTCHANGED	DATE		Last date and time record changed

29.38 Table: DISPATCHLOAD_BNC

29.38.1 DISPATCHLOAD_BNC

Name DISPATCHLOAD_BNC

Comment DISPATCHLOAD_BNC was discontinued on 30 September 2009. Prior: DISPATCHLOAD_BNC gives binding intra-regional network constraints (BNC) re-run dispatch results for all scheduled generating units. DISPATCHLOAD_BNC has a similar structure to DISPATCHLOAD but does not repeat input type data (e.g. InitialMW, AGCStatus) since these values are available from DISPATCHLOAD.

29.38.2 Description

DISPATCHLOAD_BNC was discontinued on 30 September 2009.

In accordance with the "Arrangements for Managing Risks Associated with Transmission Network Congestion" set of rule changes the Dispatch Binding Network Constraints re-run was discontinued on September 30, 2009.

Source

The occurrences of Over-constrained dispatch (OCD) or binding intra-regional network constraints (BNC) re-runs are ad hoc, with significant dependencies on the configuration or events in the physical power system. Potentially updated every 5 minutes.

DISPATCHLOAD_BNC shows data produced every 5 minutes for all units when they have over-constrained dispatch, with own data being confidential until the next day.

Volume

Rows per day: ~14000

Mb per month: 25% of DISPATCHLOAD

The basis of estimation on the number of rows is on a 25% occurrence rate for BNC runs

Note

A flag exists for each ancillary service type such that a unit trapped or stranded in one or more service type can be immediately identified. The flag is defined as follows:

Flag Name	Bit	Description	Field value
Enabled	0	The unit is enabled to provide this ancillary service type.	>1
Trapped	1	The unit is enabled to provide this ancillary service type, however the profile for this service type is causing the unit to be trapped in the energy market.	3
Stranded	2	The unit is bid available to provide this ancillary service type, however, the unit is operating in the energy market outside of the profile for this service type and is stranded from providing this service.	4

29.38.3 Notes

Name	Comment	Value
Visibility	Data in this table is:	Private; Public Next-Day

29.38.4 Primary Key Columns

Name
 DUID
 INTERVENTION
 RUNNO
 SETTLEMENTDATE

29.38.5 Index Columns

Name
 LASTCHANGED

29.38.6 Index Columns

Name
 DUID
 LASTCHANGED

29.38.7 Content

Name	Data Type	Mandatory	Comment
SETTLEMENTDATE	DATE	X	End date and time of the dispatch interval

RUNNO	NUMBER(3,0)	X	Dispatch run no; always 1
DUID	VARCHAR2(10)	X	Dispatchable unit identifier
INTERVENTION	NUMBER(2,0)	X	Intervention flag if intervention run
CONNECTIONPOINTID	VARCHAR2(12)		Connection point identifier for DUID
DISPATCHMODE	NUMBER(2,0)		Dispatch mode for fast start plant (0 to 4).
TOTALCleared	NUMBER(15,5)		Target MW for end of period
RAISEREG	NUMBER(15,5)		Raise Regulation reserve target
RAISE5MIN	NUMBER(15,5)		Raise 5 min reserve target
RAISE60SEC	NUMBER(15,5)		Raise 60 sec reserve target
RAISE6SEC	NUMBER(15,5)		Raise 6 sec reserve target
LOWERREG	NUMBER(15,5)		Lower Regulation reserve target
LOWER5MIN	NUMBER(15,5)		Lower 5 min reserve target
LOWER60SEC	NUMBER(15,5)		Lower 60 sec reserve target
LOWER6SEC	NUMBER(15,5)		Lower 6 sec reserve target
RAISEREGFLAGS	NUMBER(3,0)		Raise Reg status flag
RAISE5MINFLAGS	NUMBER(3,0)		Raise 5min status flag
RAISE60SECFLAGS	NUMBER(3,0)		Raise 60sec status flag
RAISE6SECFLAGS	NUMBER(3,0)		Raise 6sec status flag
LOWERREGFLAGS	NUMBER(3,0)		Lower Reg status flag
LOWER5MINFLAGS	NUMBER(3,0)		Lower 5min status flag
LOWER60SECFLAGS	NUMBER(3,0)		Lower 60sec status flag

LOWER6SECFLAGS	NUMBER(3,0)		Lower 6sec status flag
LASTCHANGED	DATE		Last date and time record changed

29.39 Table: DISPATCHTRK

29.39.1 DISPATCHTRK

Name DISPATCHTRK

Comment DISPATCHTRK is no longer used. DISPATCHTRK was the cross-reference between each dispatch run and SPD case run. DISPATCHTRK may be available on the InfoServer but not replicated to participant databases as it contains data duplicated in other tables.

29.39.2 Description

This is a public table, and is available to all participants.

Source

No longer used; discontinued 30/09/2001

29.39.3 Primary Key Columns

Name

RUNNO

SETTLEMENTDATE

29.39.4 Index Columns

Name

LASTCHANGED

29.39.5 Content

Name	Data Type	Mandatory	Comment
SETTLEMENTDATE	DATE	X	Market date and time starting at 04:05

RUNNO	NUMBER(3,0)	X	Dispatch run no, normally 1.
REASON	VARCHAR2(64)		Reason code (if rerun)
SPDRUNNO	NUMBER(3,0)		Case identifier for LP Solver
LASTCHANGED	DATE		Last date and time record changed

29.40 Table: FORCEMAJEURE

29.40.1 FORCEMAJEURE

Name FORCEMAJEURE

Comment FORCEMAJEURE used to set out the start and end dates / periods of any force majeure event. FORCEMAJEURE is not used.

29.40.2 Description

FORCEMAJEURE is a public table, and is available to all participants.

Source

FORCEMAJEURE is not used; was updated if a force majeure event was recorded.

29.40.3 Primary Key Columns

Name

FMID

29.40.4 Index Columns

Name

LASTCHANGED

29.40.5 Content

Name	Data Type	Mandatory	Comment
FMID	VARCHAR2(10)	X	Force Majeure Identifier
STARTDATE	DATE		Start Date for this event
STARTPERIOD	NUMBER(3,0)		Start Trading Interval for event

ENDDATE	DATE		End Date for this event
ENDPERIOD	NUMBER(3,0)		End Trading Interval for this event
APCSTARTDATE	DATE		APC Start Date
STARTAUTHORISED	VARCHAR2(15)		User authorising start
ENDAUTHORISED	VARCHAR2(15)		User authorising end of event
LASTCHANGED	DATE		Last date and time record changed

29.41 Table: FORCEMAJEUREREGION

29.41.1 FORCEMAJEUREREGION

Name FORCEMAJEUREREGION

Comment FORCEMAJEUREREGION used to set out regions impacted by a force majeure event. This table is not used.

29.41.2 Description

FORCEMAJEUREREGION is public data, and is available to all participants.

Source

FORCEMAJEUREREGION is not used; was updated if a force majeure event was recorded.

29.41.3 Primary Key Columns

Name

FMID

REGIONID

29.41.4 Index Columns

Name

LASTCHANGED

29.41.5 Content

Name	Data Type	Mandatory	Comment
FMID	VARCHAR2(10)	X	Force Majeure ID
REGIONID	VARCHAR2(10)	X	Differentiates this region from all

)		other regions
LASTCHANGED	DATE		Last date and time record changed

29.42 Table: GENUNITMTRINPERIOD

29.42.1 GENUNITMTRINPERIOD

Name	GENUNITMTRINPERIOD
Comment	GENUNITMTRINPERIOD shows meter reading by period for each generator meter. GENUNITMTRINPERIOD covers generated power flowing into the system. It is used to calculate settlement values.

29.42.2 Description

GENUNITMTRINPERIOD data is confidential to the relevant participant.

Source

GENUNITMTRINPERIOD updated only when new meter reading files are submitted by MDAs.

29.42.3 Notes

Name	Comment	Value
Visibility	Data in this table is:	Private

29.42.4 Primary Key Columns

- Name
- CONNECTIONPOINTID
- LOCAL_RETAILER
- MDA
- PARTICIPANTID
- PERIODID
- SETTLEMENTDATE
- VERSIONNO

29.42.5 Index Columns

Name

LASTCHANGED

29.42.6 Index Columns

Name

STATIONID

29.42.7 Content

Name	Data Type	Mandatory	Comment
PARTICIPANTID	VARCHAR2(10)	X	Unique participant identifier
SETTLEMENTDATE	DATE	X	Trading date of meter data submitted
VERSIONNO	NUMBER(6,0)	X	Version no of the record for the given effective date
CONNECTIONPOINTID	VARCHAR2(10)	X	Connection Point NMI
PERIODID	NUMBER(3,0)	X	Period number where 1 period ending 00:30 EST
GENUNITID	VARCHAR2(10)		Physical unit ID
STATIONID	VARCHAR2(10)		Station Identifier
IMPORTENERGYVALUE	NUMBER(16,6)		Energy sent to the pool (MWh)
EXPORTENERGYVALUE	NUMBER(16,6)		Energy received from the pool

			(MWh)
IMPORTREACTIVEVALUE	NUMBER(16,6)		Reactive power sent to the network
EXPORTREACTIVEVALUE	NUMBER(16,6)		Reactive power received from the network
LASTCHANGED	DATE		Last date and time record changed
MDA	VARCHAR2(10))	X	Relevant Metering Data Agent
LOCAL_RETAILER	VARCHAR2(10))	X	Local Retailer for this NMI

29.43 Table: INTCONTRACT

29.43.1 INTCONTRACT

Name INTCONTRACT

Comment INTCONTRACT shows intervention contract details. These are specific to each intervention.

29.43.2 Description

INTCONTRACT became unused when Ancillary Services Review was implemented in 2001.
 Confidential to participant

Source

INTCONTRACT is unused; was updated as required.

29.43.3 Primary Key Columns

Name
 CONTRACTID

29.43.4 Index Columns

Name
 LASTCHANGED

29.43.5 Content

Name	Data Type	Mandatory	Comment
CONTRACTID	VARCHAR2(10)	X	Intervention Contract Identifier
PARTICIPANTID	VARCHAR2(10)		Unique participant identifier

DUID	VARCHAR2(10))		Dispatchable Unit ID
STARTDATE	DATE		Starting Date of Contract
ENDDATE	DATE		Terminate Date of contract
STARTPERIOD	NUMBER(3,0)		Starting period of contract
ENDPERIOD	NUMBER(3,0)		Terminate period of contract in trading interval
DEREGISTRATIONDATE	DATE		Not Used
DEREGISTRATIONPERIOD	NUMBER(3,0)		Not Used
LASTCHANGED	DATE		Last changed date/time
REGIONID	VARCHAR2(10))		Region Identifier

29.44 Table: INTCONTRACTAMOUNT

29.44.1 INTCONTRACTAMOUNT

Name INTCONTRACTAMOUNT

Comment INTCONTRACTAMOUNT shows intervention contract amounts.

29.44.2 Description

INTCONTRACTAMOUNT became unused when Ancillary Services Review was implemented in 2001.

Confidential to participant

Source

INTCONTRACTAMOUNT updated with intervention contracts settlement calculations.

29.44.3 Primary Key Columns

Name

CONTRACTID

PERIODID

VERSIONNO

29.44.4 Index Columns

Name

LASTCHANGED

29.44.5 Content

Name	Data Type	Mandatory	Comment
CONTRACTID	VARCHAR2(10)	X	Intervention Contract Identifier

)		
VERSIONNO	NUMBER(3,0)	X	Intervention Contract Version
PERIODID	NUMBER(3,0)	X	Period Identifier based on calendar settlement date - YYYYMMDDPP.
AMOUNT	NUMBER(16,6)		Intervention Amount for Trading Interval
RCF	CHAR(1)		Regional Recovery Flag
LASTCHANGED	DATE	X	Last date and time record changed

29.45 Table: INTCONTRACTAMOUNTTRK

29.45.1 INTCONTRACTAMOUNTTRK

Name	INTCONTRACTAMOUNTTRK
Comment	INTCONTRACTAMOUNTTRK shows the latest valid version of each intervention contract.

29.45.2 Description

INTCONTRACTAMOUNTTRK became unused when Ancillary Services Review was implemented in 2001.
INTCONTRACTAMOUNTTRK is confidential to relevant participant

Source

INTCONTRACTAMOUNTTRK is unused; was updated for contract changes / creation only.

29.45.3 Primary Key Columns

Name
CONTRACTID
VERSIONNO

29.45.4 Index Columns

Name
LASTCHANGED

29.45.5 Content

Name	Data Type	Mandatory	Comment
CONTRACTID	VARCHAR2(10)	X	Intervention Contract Identifier

VERSIONNO	NUMBER(3,0)	X	Intervention Contract Version
AUTHORISEDBY	VARCHAR2(15))		User name
AUTHORISEDDATE	DATE		Date contract was authorised
LASTCHANGED	DATE		Last date and time record changed

29.46 Table: INTERCONNMFLOW

29.46.1 INTERCONNMFLOW

Name	INTERCONNMFLOW
Comment	<p>INTERCONNMFLOW shows Metered Interconnector flow data. INTERCONNMFLOW shows the meter data provided by Meter Data Providers to MSATS.</p> <p>Despite the name, this view shows metered energy (MWh) and not power flow (MW).</p>

29.46.2 Description

INTERCONNMFLOW data is public, available to all participants.

Source

INTERCONNMFLOW updates weekly.

Volume

The volume depends on number of interconnectors and number of loads (versions) from MSATS per settlement run.

29.46.3 Notes

Name	Comment	Value
Visibility	Data in this table is:	Public

29.46.4 Primary Key Columns

- Name
- INTERCONNECTORID
- PERIODID
- SETTLEMENTDATE

VERSIONNO

29.46.5 Index Columns

Name

LASTCHANGED

29.46.6 Content

Name	Data Type	Mandatory	Comment
SETTLEMENTDATE	DATE	X	Settlement Date (based on Trading day, not dispatch day - i.e. period 1 ends 00:30)
VERSIONNO	NUMBER(6,0)	X	Meter Data Version number
INTERCONNECTORID	VARCHAR2(10)	X	Interconnector Identifier
PERIODID	NUMBER(3,0)	X	Settlement Period identifier (half hour period)
IMPORTENERGYVALUE	NUMBER(15,6)		Imported Energy value (MWh)
EXPORTENERGYVALUE	NUMBER(15,6)		Exported Energy value (MWh)
LASTCHANGED	DATE		Record creation timestamp

29.47 Table: MARKETSUSPENSION

29.47.1 MARKETSUSPENSION

Name	MARKETSUSPENSION
Comment	MARKETSUSPENSION is obsolete from 2017 End of Year DM4.27 Release. MARKETSUSPENSION sets out a start and end periods of any market suspension and the reason.

29.47.2 Description

MARKETSUSPENSION is public data, so is available to all participants.

Source

MARKETSUSPENSION updates only if market is suspended.

29.47.3 Notes

Name	Comment	Value
Visibility	Data in this table is:	Public

29.47.4 Primary Key Columns

Name
SUSPENSIONID

29.47.5 Index Columns

Name
LASTCHANGED

29.47.6 Content

Name	Data Type	Mandatory	Comment
SUSPENSIONID	VARCHAR2(10)	X	Unique identifier for suspension
STARTDATE	DATE		Start date of suspension
STARTPERIOD	NUMBER(3,0)		Start trading interval of suspension
ENDDATE	DATE		End Date of suspension
ENDPERIOD	NUMBER(3,0)		End trading interval of suspension
REASON	VARCHAR2(64)		Reason for suspension
STARTAUTHORISED BY	VARCHAR2(15)		User authorising start
ENDAUTHORISED BY	VARCHAR2(15)		User authorising end
LASTCHANGED	DATE		Last date and time record changed

29.48 Table: MARKETSUSREGION

29.48.1 MARKETSUSREGION

Name	MARKETSUSREGION
Comment	MARKETSUSREGION is obsolete from 2017 End of Year DM4.27 Release. MARKETSUSREGION sets out a regions affected by a market suspension.

29.48.2 Description

MARKETSUSREGION is public data, so is available to all participants.

Source

MARKETSUSREGION updates only if market is suspended.

29.48.3 Notes

Name	Comment	Value
Visibility	Data in this table is:	Public

29.48.4 Primary Key Columns

Name
REGIONID
SUSPENSIONID

29.48.5 Index Columns

Name
LASTCHANGED

29.48.6 Content

Name	Data Type	Mandatory	Comment
SUSPENSIONID	VARCHAR2(10)	X	Unique identifier of suspension
REGIONID	VARCHAR2(10)	X	Differentiates this region from all other regions
LASTCHANGED	DATE		Last date and time record changed

29.49 Table: MAS_CP_CHANGE

29.49.1 MAS_CP_CHANGE

Name MAS_CP_CHANGE

Comment MAS_CP_CHANGE records pending changes to the current MAS configuration.

29.49.2 Description

Obsolete; Replaced by MSATS

Source

MAS_CP_CHANGE updates daily with each MAS export.

Note

Expiry date: When the Expiry date on a change record is reached, the change record is deleted.

Meter Read Date: only used in specific circumstances. For more details, refer to MAS documentation. The meter read date is not cleared if it becomes unusable (e.g. due to change of Metering Type or the passage of time).

29.49.3 Primary Key Columns

Name

NMI

29.49.4 Index Columns

Name

LASTCHANGED

29.49.5 Content

Name	Data Type	Mandatory	Comment
------	-----------	-----------	---------

NMI	VARCHAR2(10))	X	National Metering Identifier
STATUS_FLAG	VARCHAR2(1)		Active/Inactive flag
CP_OLD_SECURITY_CODE	VARCHAR2(4)		Old Security Code
CP_NEW_SECURITY_CODE	VARCHAR2(4)		New Security Code
OLD_LOCAL_NETWORK_PROVIDER	VARCHAR2(10))		Old Local Network Provider
OLD_LOCAL_RETAILER	VARCHAR2(10))		Old Local Retailer
OLD_FINANCIAL_PARTICIPANT	VARCHAR2(10))		Old FRMP
OLD_METERING_DATA_AGENT	VARCHAR2(10))		Old Metering Data Agent
OLD_RETAILER_OF_LAST_RESORT	VARCHAR2(10))		Old Retailer of Last Resort
OLD_RESPONSIBLE_PERSON	VARCHAR2(10))		Old Responsible Person
NEW_LOCAL_NETWORK_PROVIDER	VARCHAR2(10))		New Local Network Provider
NEW_LOCAL_RETAILER	VARCHAR2(10))		New Local Retailer
NEW_FINANCIAL_PARTICIPANT	VARCHAR2(10))		New FRMP
NEW_METERING_DATA_AGENT	VARCHAR2(10))		New Metering Data Agent
NEW_RETAILER_OF_LAST_RESORT	VARCHAR2(10))		New Retailer of Last Resort
NEW_RESPONSIBLE_PERSON	VARCHAR2(10)		New Responsible Person

N)		
OLD_LNSP_OK	VARCHAR2(1)		Old LNSP approval flag
OLD_LR_OK	VARCHAR2(1)		Old LR approval flag
OLD_FRMP_OK	VARCHAR2(1)		Old FRMP approval flag
OLD_MDA_OK	VARCHAR2(1)		Old MDA approval flag
OLD_ROLR_OK	VARCHAR2(1)		Old ROLR approval flag
OLD_RP_OK	VARCHAR2(1)		Old RP approval flag
NEW_LNSP_OK	VARCHAR2(1)		New LNSP approval flag
NEW_LR_OK	VARCHAR2(1)		New LR approval flag
NEW_FRMP_OK	VARCHAR2(1)		New FRMP approval flag
NEW_MDA_OK	VARCHAR2(1)		New MDA approval flag
NEW_ROLR_OK	VARCHAR2(1)		New ROLR approval flag
NEW_RP_OK	VARCHAR2(1)		New RP approval flag
PRUDENTIAL_OK	VARCHAR2(1)		Prudential check flag
INITIAL_CHANGE_DATE	DATE		Initial change date
CURRENT_CHANGE_DATE	DATE		Current change date
CP_NAME	VARCHAR2(30)		Connection point name
CP_DETAIL_1	VARCHAR2(30)		Connection point detail 1
CP_DETAIL_2	VARCHAR2(30)		Connection point detail 2
CITY_SUBURB	VARCHAR2(30)		Connection point City/Suburb

STATE	VARCHAR2(3)		State of Australia
POST_CODE	VARCHAR2(4)		Connection point postcode
TX_NODE	VARCHAR2(4)		Connection point TNI
AGGREGATE_DATA	VARCHAR2(1)		Aggregate data Flag (YIN)
AVERAGE_DAILY_LOAD_KWH	NUMBER(8,0)		Average Daily load in KWh
DISTRIBUTION_LOSS	NUMBER(5,4)		Distribution loss factors
OLD_LSNP_TEXT	VARCHAR2(30))		Old LNSP text field (LNSP misspelt in name)
OLD_LR_TEXT	VARCHAR2(30))		Old LR text field
OLD_FRMP_TEXT	VARCHAR2(30))		Old FRMP text field
OLD_MDA_TEXT	VARCHAR2(30))		Old MDA text field
OLD_ROLR_TEXT	VARCHAR2(30))		Old ROLR text field
OLD_RP_TEXT	VARCHAR2(30))		Old RP text field
NEW_LSNP_TEXT	VARCHAR2(30))		New LNSP text field (LNSP misspelt in name)
NEW_LR_TEXT	VARCHAR2(30))		New LR text field
NEW_FRMP_TEXT	VARCHAR2(30))		New FRMP text field
NEW_MDA_TEXT	VARCHAR2(30))		New MDA text field

NEW_ROLR_TEXT	VARCHAR2(30)		New ROLR text field
NEW_RP_TEXT	VARCHAR2(30)		New RP text field
LASTCHANGED	DATE		Last changed date.
NMI_CLASS	VARCHAR2(9)		Class of National Metering Identifier to allow for different business rules to apply
METERING_TYPE	VARCHAR2(9)		Type of metering installation (e.g. BASIC, MRIM, COMMS)
JURISDICTION	VARCHAR2(3)		Area; for application of rules
CREATE_DATE	DATE		Set by the system with today's date when the change record is created.
EXPIRY_DATE	DATE		Set by the system (and cannot be changed).
METER_READ_DATE	DATE		Date of meter reading

29.50 Table: MAS_CP_MASTER

29.50.1 MAS_CP_MASTER

Name MAS_CP_MASTER

Comment MAS_CP_MASTER shows the current MAS configuration.

29.50.2 Description

Obsolete; Replaced by MSATS

Source

MAS_CP_MASTER updates daily with each MAS export.

Note

In_Use Value	Meaning
Y	ACTIVE
N	CLOSED
X	EXTINCT

29.50.3 Primary Key Columns

Name

NMI

VALID_FROM_DATE

29.50.4 Primary Key Columns

Name

NMI

VALID_TO_DATE

29.50.5 Index Columns

Name

LASTCHANGED

29.50.6 Content

Name	Data Type	Mandatory	Comment
NMI	VARCHAR2(10)	X	National Metering Identifier
CP_SECURITY_CODE	VARCHAR2(4)		Security Code
IN_USE	VARCHAR2(1)		Active/Inactive Status flag (NEW/N/Y/X)
VALID_FROM_DATE	DATE	X	Record valid from date
VALID_TO_DATE	DATE	X	Record valid to date
LOCAL_NETWORK_PROVIDER	VARCHAR2(10)		LNSP
LOCAL_RETAILER	VARCHAR2(10)		Local Retailer
FINANCIAL_PARTICIPANT	VARCHAR2(10)		FRMP
METERING_DATA_AGENT	VARCHAR2(10)		MDA
RETAILER_OF_LAST_RESORT	VARCHAR2(10)		ROLR
RESPONSIBLE_PERSON	VARCHAR2(10)		Responsible Person
CP_NAME	VARCHAR2(30)		Connection point name
CP_DETAIL_1	VARCHAR2(30)		Connection point detail 1

)		
CP_DETAIL_2	VARCHAR2(30)		Connection point detail 2
CITY_SUBURB	VARCHAR2(30)		Connection point city/suburb
STATE	VARCHAR2(3)		State of Australia
POST_CODE	VARCHAR2(4)		Connection point postcode
TX_NODE	VARCHAR2(4)		Connection point TNI
AGGREGATE_DATA	VARCHAR2(1)		Aggregate data flag (YIN)
AVERAGE_DAILY_LOAD_K WH	NUMBER(8,0)		Average daily load in KWh
DISTRIBUTION_LOSS	NUMBER(5,4)		Distribution loss factor
LSNP_TEXT	VARCHAR2(30)		LNSP text field (name has misspelt LNSP)
LR_TEXT	VARCHAR2(30)		LR text field
FRMP_TEXT	VARCHAR2(30)		FRMP text field
MDA_TEXT	VARCHAR2(30)		MDA text field
ROLR_TEXT	VARCHAR2(30)		ROLR text field
RP_TEXT	VARCHAR2(30)		RP text field
LASTCHANGED	DATE		Last changed date
NMI_CLASS	VARCHAR2(9)		

METERING_TYPE	VARCHAR2(9)		
JURISDICTION	VARCHAR2(3)		

29.51 Table: METERDATA

29.51.1 METERDATA

Name	METERDATA
Comment	METERDATA sets out a meter data for each customer connection point. METERDATA covers market load. Use the field METERRUNNO to match the meter data version for each settlement run.

29.51.2 Description

METERDATA data is confidential to the relevant participant.

Source

METERDATA updates whenever meter files are processed from MSATS.

Volume

Depends on number of TNI, FRMP, LR combinations and number of data file loads (versions) from MSATS per settlement run.

29.51.3 Notes

Name	Comment	Value
Visibility	Data in this table is:	Private

29.51.4 Primary Key Columns

- Name
- CONNECTIONPOINTID
- HOSTDISTRIBUTOR
- MDA
- METERRUNNO
- PARTICIPANTID

PERIODID

SETTLEMENTDATE

29.51.5 Index Columns

Name

LASTCHANGED

29.51.6 Content

Name	Data Type	Mandatory	Comment
PARTICIPANTID	VARCHAR2(10)	X	Unique participant identifier
PERIODID	NUMBER(3,0)	X	Settlement period identifier (half hour period)
SETTLEMENTDATE	DATE	X	Settlement date
METERRUNNO	NUMBER(6,0)	X	Data version no
CONNECTIONPOINTID	VARCHAR2(10)	X	Transmission Node Identifier (TNI). Identifies a Transmission NetworkConnection Point.
IMPORTENERGYVALUE	NUMBER(9,6)		Imported energy value (MWh)
EXPORTENERGYVALUE	NUMBER(9,6)		Exported energy value (MWh)
IMPORTREACTIVEVALUE	NUMBER(9,6)		Not used
EXPORTREACTIVEVALUE	NUMBER(9,6)		Not used
HOSTDISTRIBUTOR	VARCHAR2(10)	X	Local Retailer participant identifier

LASTCHANGED	DATE		Last date and time record changed
MDA	VARCHAR2(10)	X	Defaults to MSATS

29.52 Table: METERDATA_GEN_DUID

29.52.1 METERDATA_GEN_DUID

Name METERDATA_GEN_DUID

Comment Recorded actual generation of non-scheduled units where SCADA data is available.

29.52.2 Notes

Name	Comment	Value
Visibility	Data in this table is:	Public

29.52.3 Primary Key Columns

Name

DUID

INTERVAL_DATETIME

29.52.4 Index Columns

Name

LASTCHANGED

29.52.5 Content

Name	Data Type	Mandatory	Comment
INTERVAL_DATETIME	date	X	Timestamp of the recorded interval
DUID	varchar2(10)	X	Unit ID

MWH_READING	number(18,8)		MW reading
LASTCHANGED	date		Timestamp of last record change

29.53 Table: METERDATATRK

29.53.1 METERDATATRK

Name	METERDATATRK
Comment	METERDATATRK records meter data files submitted for each connection point on a daily basis. The same data is provided in METERDATA period by period (i.e. 48 records), whereas METERDATATRK shows one record per day for each file submitted for a connection point.

29.53.2 Description

METERDATATRK data is confidential to the relevant participant.

Source

METERDATATRK updates whenever meter files are processed.

Volume

Depends on the number of TNI, FRMP and LR combinations plus the number of data file loads (versions) from MSATS per settlement run.

29.53.3 Notes

Name	Comment	Value
Visibility	Data in this table is:	Private

29.53.4 Primary Key Columns

- Name
- CONNECTIONPOINTID
- HOSTDISTRIBUTOR
- METERINGDATAAGENT
- METERRUNNO

PARTICIPANTID

SETTLEMENTDATE

29.53.5 Index Columns

Name

LASTCHANGED

29.53.6 Content

Name	Data Type	Mandatory	Comment
SETTLEMENTDATE	DATE	X	Settlement calendar date
METERRUNNO	NUMBER(6,0)	X	Meter data version number
PARTICIPANTID	VARCHAR2(10)	X	Participant identifier
FILENAME	VARCHAR2(40)		Meter file name (MSATS file name)
ACKFILENAME	VARCHAR2(40)		Not used
CONNECTIONPOINTID	VARCHAR2(10)	X	Transmission Node Identifier (TNI)
AUTHORISEDDATE	DATE		Date processed
AUTHORISED BY	VARCHAR2(15)		Not used
METERINGDATAAGENT	VARCHAR2(10)	X	Defaults to MSATS
HOSTDISTRIBUTOR	VARCHAR2(10)	X	Local retailer participant identifier

)		
LASTCHANGED	DATE		Last date and time record changed

29.54 Table: MTPASA_CASE_SET

29.54.1 MTPASA_CASE_SET

Name MTPASA_CASE_SET

Comment MTPASA_CASE_SET is obsolete from 2005 End of Year Release. The RUNTYPE added to the primary key of the detail tables for MTPASA allows for the different types of runs for each case.
MTPASA_CASE_SET allows a MT PASA scenario to be linked across runs.

29.54.2 Description

Source

Update weekly.

29.54.3 Notes

Name	Comment	Value
Visibility	Data in this table is:	Public

29.54.4 Primary Key Columns

- Name
- RUN_DATETIME
- RUN_NO

29.54.5 Index Columns

- Name
- LASTCHANGED

29.54.6 Content

Name	Data Type	Mandatory	Comment
RUN_DATETIME	DATE	X	Date processing of the run begins. Generated from the solution file CASEID.
RUN_NO	NUMBER(3,0)	X	Unique run id. Generated from the solution file CASEID.
CASESETID	NUMBER(3,0)		Unique id to link a set of cases run from the same inputs
RUNTYPEID	NUMBER(1,0)		Unique id for type of run, being either
LASTCHANGED	DATE		Date the solution was loaded

29.55 Table: MTPASA_CASESOLUTION

29.55.1 MTPASA_CASESOLUTION

Name	MTPASA_CASESOLUTION
Comment	<p>MTPASA_CASESOLUTION is obsolete from 2017 End of Year DM4.27 Release.</p> <p>MTPASA_CASESOLUTION holds one record for each entire solution.</p> <p>Change Notice 379 announced the replacement of the MT PASA data model so all MTPASAxXX tables become obsolete, replaced by MTPASA_XXX tables.</p>

29.55.2 Description

MTPASA_CASESOLUTION is public data.

Source

MTPASA_CASESOLUTION is updated each MTPASA run (i.e. weekly).

Volume

Rows per week: 1

Rows per month: 5

Monthly space increment is based on storing all the MT PASA solutions. To store only the latest solution, divide these figures by 5 (number of weeks per month rounded up).

29.55.3 Notes

Name	Comment	Value
Visibility	Data in this table is:	Public

29.55.4 Primary Key Columns

- Name
- RUN_DATETIME
- RUN_NO

29.55.5 Index Columns

Name

LASTCHANGED

29.55.6 Content

Name	Data Type	Mandatory	Comment
RUN_DATETIME	DATE	X	Date processing of the run begins. Generated from the solution file caseid
RUN_NO	NUMBER(3,0)	X	Unique run id. Generated from the solution file caseid
PASAVERSION	VARCHAR2(10)		Version of the PASA solver used to solve this case
RESERVECONDITION	NUMBER(1,0)		Low Reserve Condition (LRC) flag for the case (1 - LRC in the case, 0 - No LRCs in the case) for capacity run
LORCONDITION	NUMBER(1,0)		Lack of Reserve Condition (LOR) flag for the case indicates the most severe condition in the case (3 = LOR3, 2 = LOR2, 1 = LOR1, 0 = No LOR)
CAPACITYOBJFUNCTION	NUMBER(12,3)		Objective Function from the Capacity Adequacy run
CAPACITYOPTION	NUMBER(12,3)		Not populated as of 2005 End of Year Release; was the demand forecast used for capacity adequacy assessment: 0 = no assessment, 1 = 10%, 2 = 50%, 3 =

			90%
MAXSURPLUSRESERVEOPTION	NUMBER(12,3)		Not populated as of 2005 End of Year Release; was the demand forecast used for assessment of Maximum surplus Reserve: 0 = no assessment, 1 = 10%, 2 = 50%, 3 = 90%
MAXSPARECAPACITYOPTION	NUMBER(12,3)		Not populated as of 2005 End of Year Release; was the demand forecast used for assessment of Maximum Spare Capacity: 0 = no assessment, 1 = 10%, 2 = 50%, 3 = 90%
INTERCONNECTORFLOWPENALTY	NUMBER(12,3)		The penalty for non-zero interconnector flow
LASTCHANGED	DATE		Date and time the record was created or modified
RUNTYPE	VARCHAR2(50)		Discontinued in Dec 2005; was description of the constraints included in this run, being either System Normal and Planned Outage Constraints or System Normal Constraints Only
RELIABILITYLRCDEMANDOPTION	NUMBER(12,3)		Specifies the Probability of Exceedence (POE) demand forecast for Reliability LRC assessment (0 if no assessment, 10 for 10%, 50 for 50%, 90 for 90%)
OUTAGELRCDEMANDOPTION	NUMBER(12,3)		Specifies the Probability of Exceedence (POE) demand forecast for outage LRC assessment (0 if no assessment, 10 for 10%, 50 for 50%, 90 for 90%)

LORDEMANDOPTION	NUMBER(12,3)		Specifies the Probability of Exceedence (POE) demand forecast for LOR assessment (0 if no assessment, 10 for 10%, 50 for 50%, 90 for 90%)
RELIABILITYLRCCAPACITYOPTION	VARCHAR2(10)		Generation Availability to be used in Reliability LRC run (either PASA or MARKET)
OUTAGELRCCAPACITYOPTION	VARCHAR2(10)		Generation Availability to be used in Outage LRC run (either PASA or MARKET)
LORCAPACITYOPTION	VARCHAR2(10)		Generation Availability to be used in LOR run (either PASA or MARKET)
LORUIGFOption	NUMBER(3,0)		UIGF POE forecast availability used for this option
ReliabilityLRCUIGFOption	NUMBER(3,0)		UIGF POE forecast availability used for this option
OutageLRCUIGFOption	NUMBER(3,0)		UIGF POE forecast availability used for this option

29.56 Table: MTPASA_CONSTRAINTSOLUTION

29.56.1 MTPASA_CONSTRAINTSOLUTION

Name MTPASA_CONSTRAINTSOLUTION

Comment MTPASA_CONSTRAINTSOLUTION is obsolete from 2017 End of Year DM4.27 Release.

The MTPASA_CONSTRAINTSOLUTION table holds the binding and violated constraint results from the capacity evaluation, including the RHS value.

Change Notice 379 announced the replacement of the MT PASA data model so all MTPASAxXX tables become obsolete, replaced by MTPASA_XXX tables.

29.56.2 Description

MTPASA_CONSTRAINTSOLUTION is public data.

Source

MTPASA_CONSTRAINTSOLUTION is updated each MTPASA run (i.e. weekly).

Volume

Rows per week: 230

To store only the latest solution, divide these figures by 5.

29.56.3 Notes

Name	Comment	Value
Visibility	Data in this table is:	Public

29.56.4 Primary Key Columns

- Name
- CONSTRAINTID
- DAY

ENERGYBLOCK

LDCBLOCK

RUN_DATETIME

RUN_NO

RUNTYPE

29.56.5 Index Columns

Name

LASTCHANGED

29.56.6 Content

Name	Data Type	Mandatory	Comment
RUN_DATETIME	DATE	X	Date processing of the run begins
RUN_NO	NUMBER(3,0)	X	Unique run id. Generated from the solution file caseid
ENERGYBLOCK	DATE	X	Sunday at start of the week for this solutions energy block. Generated from the solution file energy block
DAY	DATE	X	Day this solution is for. Generated from the solution file periodid
LDCBLOCK	NUMBER(3,0)	X	LDC block this solution is for. Generated from the solution file periodid
CONSTRAINTID	VARCHAR2(20)	X	The unique identifier for the constraint

CAPACITYRHS	NUMBER(12,2)		The RHS value in the capacity evaluation
CAPACITYMARGINALVALUE	NUMBER(12,2)		Capacity adequacy assessment marginal value; 0 if not binding
CAPACITYVIOLATIONDEGREE	NUMBER(12,2)		Capacity adequacy assessment violation degree; 0 if not violating
LASTCHANGED	DATE		Date the solution was loaded
RUNTYPE	VARCHAR2(20)	X	Type of run. Values are RELIABILITY_LRC and OUTAGE_LRC

29.57 Table: MTPASA_INTERCONNECTORSOLUTION

29.57.1 MTPASA_INTERCONNECTORSOLUTION

Name MTPASA_INTERCONNECTORSOLUTION

Comment MTPASA_INTERCONNECTORSOLUTION is obsolete from 2017 End of Year DM4.27 Release.

The MTPASA_INTERCONNECTORSOLUTION table shows the results of the capacity evaluation for Interconnectors, including the calculated limits for the Idcblock within the day.

Change Notice 379 announced the replacement of the MT PASA data model so all MTPASAxXX tables become obsolete, replaced by MTPASA_XXX tables (see Change Notices 400, 400a and 400b).

29.57.2 Description

MTPASA_INTERCONNECTORSOLUTION is public so is available to all participants.

Source

MTPASA_INTERCONNECTORSOLUTION is updated each MTPASA run (i.e. weekly).

Volume

Rows per week: 35280

To store only the latest solution, divide these figures by 5 (number of weeks per month rounded up).

29.57.3 Notes

Name	Comment	Value
Visibility	Data in this table is:	Public

29.57.4 Primary Key Columns

- Name
- DAY
- ENERGYBLOCK

INTERCONNECTORID

LDCBLOCK

RUN_DATETIME

RUN_NO

RUNTYPE

29.57.5 Index Columns

Name

LASTCHANGED

29.57.6 Content

Name	Data Type	Mandatory	Comment
RUN_DATETIME	DATE	X	Date processing of the run begins
RUN_NO	NUMBER(3,0)	X	Unique run id. Generated from the solution file caseid
ENERGYBLOCK	DATE	X	Sunday at start of the week for this solutions energy block. Generated from the solution file energy block
DAY	DATE	X	Day this solution is for. Generated from the solution file periodid
LDCBLOCK	NUMBER(3,0)	X	LDC block this solution is for. Generated from the solution file periodid
INTERCONNECTORID	VARCHAR2(10)	X	The unique identifier for the interconnector

CAPACITYMWFLOW	NUMBER(12,2)		Interconnector loading level (MW) that can be reached in case of capacity scarcity in neighbouring regions subject to network and energy constraints
CAPACITYMARGINALVALUE	NUMBER(12,2)		Capacity adequacy assessment marginal value; 0 if not binding
CAPACITYVIOLATIONDEGREE	NUMBER(12,2)		Capacity adequacy assessment violation degree, 0 if not violating; where CapacityMWFlow <= export + violation Degree (Deficit)CapacityMWFlow >= import + CapacityViolationDegree (Deficit)
CALCULATEDEXPORTLIMIT	NUMBER(12,2)		Calculated Interconnector limit of exporting energy on the basis of invoked constraints and static interconnector export limit
CALCULATEDIMPORTLIMIT	NUMBER(12,2)		Calculated Interconnector limit of importing energy on the basis of invoked constraints and static interconnector import limit. Note unlike the input interconnector import limit this is a directional quantity and should be defined with respect to the interconnector flow
LASTCHANGED	DATE		Date the solution was loaded
RUNTYPE	VARCHAR2(20)	X	Type of run. Values are RELIABILITY_LRC and OUTAGE_LRC
EXPORTLIMITCONSTRAINTID	VARCHAR2(20)		ID of the constraint that sets the Interconnector Export Limit
IMPORTLIMITCONSTRAINT	VARCHAR2(20)		ID of the constraint that sets the

ID)		Interconnector Import Limit
----	---	--	-----------------------------

29.58 Table: MTPASA_REGIONSOLUTION

29.58.1 MTPASA_REGIONSOLUTION

Name	MTPASA_REGIONSOLUTION
Comment	MTPASA_CASESOLUTION is obsolete from 2017 End of Year DM4.27 Release. The MTPASA_REGIONSOLUTION table shows the results of the regional capacity, maximum surplus reserve and maximum spare capacity evaluations for each day and ldcblock of the study.

29.58.2 Description

MTPASA_REGIONSOLUTION is public so is available to all participants.

Source

MTPASA_REGIONSOLUTION is updated each MTPASA run (i.e. weekly).

Volume

Rows per week: 29400

To store only the latest solution, divide these figures by 5 (number of weeks per month rounded up).

29.58.3 Notes

Name	Comment	Value
Visibility	Data in this table is:	Public

29.58.4 Primary Key Columns

- Name
- DAY
- ENERGYBLOCK
- LDCBLOCK
- REGIONID

RUN_DATETIME

RUN_NO

RUNTYPE

29.58.5 Index Columns

Name

LASTCHANGED

29.58.6 Content

Name	Data Type	Mandatory	Comment
RUN_DATETIME	DATE	X	Date processing of the run begins
RUN_NO	NUMBER(3,0)	X	Unique run id. Generated from the solution file caseid
ENERGYBLOCK	DATE	X	Sunday at start of the week for this solutions energy block. Generated from the solution file energy block
DAY	DATE	X	Day this solution is for. Generated from the solution file periodid
LDCBLOCK	NUMBER(3,0)	X	LDC block this solution is for. Generated from the solution file periodid
REGIONID	VARCHAR2(10)	X	The unique region identifier
DEMAND10	NUMBER(12,2)		Input value for 10% probability demand
RESERVEREQ	NUMBER(12,2)		Not used from 21/05/2010. Prior to

			21/05/2010: Input reserve requirement
CAPACITYREQ	NUMBER(12,2)		Not used from 21/05/2010. Prior to 21/05/2010: CA Demand + Reserve Requirement
ENERGYREQDEMAND10	NUMBER(12,2)		Sum of: (Region Period Demand - given Demand10)/PeriodLength(sum by Energy Block, entered in first period of energy block, GWh)
UNCONSTRAINEDCAPACITY	NUMBER(12,0)		Region energy unconstrained MW capacity subject to network security constraints
CONSTRAINEDCAPACITY	NUMBER(12,0)		Region energy constrained MW capacity subject to energy and network security constraints
NETINTERCHANGEUNDER SCARCITY	NUMBER(12,2)		Calculated in capacity adequacy evaluation: Export if > 0, Import if < 0.
SURPLUSCAPACITY	NUMBER(12,2)		Regional surplus capacity MW, +/- values indicate surplus/deficit capacity
SURPLUSRESERVE	NUMBER(12,2)		Not used from 21/05/2010. Prior to 21/05/2010: Regional reserve surplus. +/- values indicate surplus/deficit reserve
RESERVECONDITION	NUMBER(1,0)		The regional reserve condition: 0 = Adequate, 1 = LRC
MAXSURPLUSRESERVE	NUMBER(12,2)		The Maximum generation (MW) that could be withdrawn from this region without incurring a Low Reserve Condition.

MAXSPARECAPACITY	NUMBER(12,2)		The Maximum Spare Capacity evaluated for this region in this period. Calculated for each region in turn
LORCONDITION	NUMBER(1,0)		The LOR Condition determined from the Maximum Spare Capacity value: 0 = no condition, 1 = LOR1 condition, 2 = LOR2 condition, 3 = LOR3 condition
AGGREGATECAPACITYAVAILABLE	NUMBER(12,2)		Sum of MAXAVAIL quantities offered by all Scheduled Generators in a given Region for a given PERIODID.
AGGREGATESCHEDULEDLOAD	NUMBER(12,2)		Sum of MAXAVAIL quantities bid by of all Scheduled Loads in a given Region for a given PERIODID.
LASTCHANGED	DATE		Date the solution was loaded
AGGREGATEPASAAVAILABLE	NUMBER(12,0)		Sum of PASAAVAILABILITY quantities offered by all Scheduled Generators in a given Region for a given PERIODID.
RUNTYPE	VARCHAR2(20)	X	Type of run. Values are RELIABILITY_LRC and OUTAGE_LRC
CALCULATEDLOR1LEVEL	NUMBER(16,6)		Region Reserve Level for LOR1 used. Can be static value or calculated value if an interconnector is a credible contingency
CALCULATEDLOR2LEVEL	NUMBER(16,6)		Region Reserve Level for LOR2 used. Can be static value or calculated value if an interconnector is a credible

			contingency
MSRNETINTERCHANGEUN DERSCARCITY	NUMBER(12,2)		Net interconnector flow from the region for this interval from the MSR assessment
LORNETINTERCHANGEUN DERSCARCITY	NUMBER(12,2)		Net interconnector flow from the region for this interval from the LOR assessment
TOTALINTERMITTENTGENE RATION	NUMBER(15,5)		Allowance made for non-scheduled generation in the demand forecast (MW).
DEMAND50	NUMBER(12,2)		Input value for 50% probability demand
DEMAND_AND_NONSCHE DGEN	NUMBER(15,5)		Sum of Cleared Scheduled generation, imported generation (at the region boundary) and allowances made for non-scheduled generation (MW).
UIGF	NUMBER(12,2)		Regional aggregated Unconstrained Intermittent Generation Forecast of Semi-scheduled generation (MW).
SEMISCHEDULEDCAPACIT Y	NUMBER(12,2)		Aggregate Regional UIGF availability
LOR_SEMISCHEDULEDCAP ACITY	NUMBER(12,2)		Aggregate Regional UIGF availability for LOR
DEFICITRESERVE	NUMBER(16,6)		Regional reserve deficit (MW)
MAXUSEFULRESPONSE	NUMBER(12,2)		The Maximum market response (MW) needed for the region to eliminate a Low Reserve Condition (LRC)
MURNETINTERCHANGEUN	NUMBER(12,2)		Net interconnector flow from the

DERSCARCITY			region for this interval from the MRR assessment
LORTOTALINTERMITTENT GENERATION	NUMBER(15,5)		Allowance made for non-scheduled generation in the LOR assessment
ENERGYREQDEMAND50	number(12,2)		Sum of: (Region Period Demand - given Demand50)/PeriodLength (sum by Energy Block, entered in first period of energy block, GWh)

29.59 Table: MTPASA_RESERVELIMITSOLUTION

29.59.1 MTPASA_RESERVELIMITSOLUTION

Name	MTPASA_RESERVELIMITSOLUTION
Comment	MTPASA_RESERVELIMITSOLUTION is obsolete from 2017 End of Year DM4.27 Release. MT PASA Solution table reporting whether a MT PASA Reserve requirement is binding for each day and LDC block of the run.

29.59.2 Description

Source

MTPASA_RESERVELIMITSOLUTION is updated each MTPASA run (i.e. weekly).

Volume

400,000 rows per year

29.59.3 Notes

Name	Comment	Value
Visibility	Data in this table is:	Public

29.59.4 Primary Key Columns

- Name
- DAY
- ENERGYBLOCK
- LDCBLOCK
- RESERVELIMITID
- RUN_DATETIME
- RUN_NO

RUNTYPE

29.59.5 Content

Name	Data Type	Mandatory	Comment
RUN_DATETIME	DATE	X	Date processing of the run begins
RUN_NO	NUMBER(3,0)	X	Unique run ID. Generated from the solution file Case ID.
RUNTYPE	VARCHAR2(20)	X	Type of run. Values are RELIABILITY_LRC and OUTAGE_LRC
ENERGYBLOCK	DATE	X	Sunday at start of the week for this solutions energy block. Generated from the solution file energy block.
DAY	DATE	X	Day this solution is for. Generated from the solution file period id.
LDCBLOCK	NUMBER(3,0)	X	Load Duration Curve block this solution is for. Generated from the solution file period id.
RESERVELIMITID	VARCHAR2(20)	X	The unique identifier of the MT PASA LRC Reserve Requirement.
MARGINALVALUE	NUMBER(16,6)		Marginal Value of the Reserve Requirement Constraint. A non-zero value indicates that the reserve requirement is binding.
LASTCHANGED	DATE		Timestamp the record was last modified.

29.60 Table: MTPASACONSTRAINTSOLUTION_D

29.60.1 MTPASACONSTRAINTSOLUTION_D

Name MTPASACONSTRAINTSOLUTION_D

Comment MTPASACONSTRAINTSOLUTION_D sets out MT PASA constraint solution results, where constraints are binding.

29.60.2 Description

MTPASACONSTRAINTSOLUTION_D is public data.

Source

MTPASACONSTRAINTSOLUTION_D updates weekly.

Volume

Each run overwrites data from previous runs for all future dates. Growth is one record per newly effective constraint.

29.60.3 Primary Key Columns

Name

CONSTRAINT_ID

DATETIME

29.60.4 Index Columns

Name

LASTCHANGED

29.60.5 Content

Name	Data Type	Mandatory	Comment
DATETIME	DATE	X	Date constraint is binding

CONSTRAINT_ID	VARCHAR2(20)	X	Constraint Identifier
DEGREE_OF_VIOLATION	NUMBER(16,6)		The degree in MW by which the constraint would be violated if the solution could not solve. This could be due to incorrect penalties etc. This figure should always be 0.
LASTCHANGED	DATE		Last changed data and time.
RUN_DATETIME	DATE		The run date and time

29.61 Table: MTPASAINTERCONNECTORSOLUTION_D

29.61.1 MTPASAINTERCONNECTORSOLUTION_D

Name MTPASAINTERCONNECTORSOLUTION_D

Comment MTPASAINTERCONNECTORSOLUTION_D shows interconnector results for MT PASA, shown region by region.

29.61.2 Description

MTPASAINTERCONNECTORSOLUTION_D is public data.

Source

MTPASAINTERCONNECTORSOLUTION_D updates weekly.

Volume

Each run overwrites data from previous runs for all future dates. Growth is one record per day per interconnector.

29.61.3 Primary Key Columns

Name

DATETIME

INTERCONNECTOR_ID

29.61.4 Index Columns

Name

LASTCHANGED

29.61.5 Content

Name	Data Type	Mandatory	Comment
DATETIME	DATE	X	Date of results. One record for

			each day for next two years.
INTERCONNECTOR_ID	VARCHAR2(12)	X	Interconnector Identifier
POSITIVE_INTERCONNECTOR_FLOW	NUMBER(16,6)		The MW flow out
POSITIVE_TRANSFER_LIMITS	NUMBER(16,6)		The MW transfer limits out
POSITIVE_BINDING	VARCHAR2(10)		Indication of a binding limit in the out direction
NEGATIVE_INTERCONNECTOR_FLOW	NUMBER(16,6)		The MW flow in
NEGATIVE_TRANSFER_LIMITS	NUMBER(16,6)		the MW transfer limits in
NEGATIVE_BINDING	VARCHAR2(10)		Indication of a binding limit in the in direction
LASTCHANGED	DATE		Last change date and time
RUN_DATETIME	DATE		The run date and time

29.62 Table: MTPASAREGIONSOLUTION_D

29.62.1 MTPASAREGIONSOLUTION_D

Name MTPASAREGIONSOLUTION_D

Comment MTPASAREGIONSOLUTION_D shows region results for MT PASA, showing predicted demand and any capacity limits.

29.62.2 Description

MTPASAREGIONSOLUTION_D is public data.

Source

MTPASAREGIONSOLUTION_D updates weekly.

Volume

Each run overwrites data from previous runs for all future dates. Growth is one record per day per region.

29.62.3 Primary Key Columns

Name

DATETIME

REGION_ID

29.62.4 Index Columns

Name

LASTCHANGED

29.62.5 Content

Name	Data Type	Mandatory	Comment
DATETIME	DATE	X	Date of results. One record for

			each day for next two years.
REGION_ID	VARCHAR2(12)	X	Region Identifier
RUN_DATETIME	DATE		The run date and time
RESERVE_CONDITION	VARCHAR2(50)		The regional reserve condition
RESERVE_SURPLUS	NUMBER(16,6)		Regional reserve surplus value
CAPACITY_REQUIREMENT	NUMBER(16,6)		Capacity in MW required to meet demand
MINIMUM_RESERVE_REQUIREMENT	NUMBER(16,6)		Minimum required regional reserve value
REGION_DEMAND_10POE	NUMBER(16,6)		Regional 10% Probability of Exceedance demand forecast value
DEMAND_MINUS_SCHEDULED_LOAD	NUMBER(16,6)		Regional demand minus the scheduled load value
CONSTRAINED_CAPACITY	NUMBER(16,6)		The total regional capacity due to energy and network constraints
UNCONSTRAINED_CAPACITY	NUMBER(16,6)		The total regional capacity, subject to network constraints.
NET_INTERCHANGE	NUMBER(16,6)		Regional net MW import via interconnectors
ENERGY_REQUIREMENT_10POE	NUMBER(16,6)		Regional energy required to meet demand
REPORTED_BLOCK_ID	NUMBER(16,6)		The load duration curve block that is recorded in the report.
LASTCHANGED	DATE		Last change date and time.

29.63 Table: OARTRACK

29.63.1 OARTRACK

Name	OARTRACK
Comment	OARTRACK shows an audit trail of bids for a particular settlement day. Corrupt bids do not update OARTRACK, but are just in OFFERFILETRK.

29.63.2 Description

Not in Use - discontinued 16/11/2003

Status

The OARTRACK table is obsolete. Please refer to BIDOFFERFILETRK. As a transition assist, the OARTRACK views expose data based on BIDOFFERFILETRK.

Source

Own (confidential) data updates as bids are processed. All bids are available as part of next day market data.

29.63.3 Primary Key Columns

Name
OFFERDATE
PARTICIPANTID
SETTLEMENTDATE
VERSIONNO

29.63.4 Index Columns

Name
LASTCHANGED

29.63.5 Index Columns

Name

PARTICIPANTID

29.63.6 Content

Name	Data Type	Mandatory	Comment
SETTLEMENTDATE	DATE	X	Settlement date
OFFERDATE	DATE	X	Date file offered
VERSIONNO	NUMBER(3,0)	X	Version no for this offer date
PARTICIPANTID	VARCHAR2(10)	X	Unique participant identifier
FILENAME	VARCHAR2(40)		Load file name
AUTHORISEDDATE	DATE		Date record authorised
AUTHORISEDBY	VARCHAR2(10)		User authorising record
LASTCHANGED	DATE		Last date and time record changed

29.64 Table: OFFERFILETRK

29.64.1 OFFERFILETRK

Name	OFFERFILETRK
Comment	OFFERFILETRK shows an audit trail of all bid files submitted containing energy bids, including corrupt bids/rebids.

29.64.2 Description

Status

OFFERFILETRK is obsolete. Please see BIDOFFERFILETRK.

Source

OFFERFILETRK is obsolete.

29.64.3 Primary Key Columns

Name
FILENAME
OFFERDATE
PARTICIPANTID

29.64.4 Index Columns

Name
LASTCHANGED

29.64.5 Index Columns

Name
PARTICIPANTID

29.64.6 Content

Name	Data Type	Mandatory	Comment
OFFERDATE	DATE	X	Date file offered
PARTICIPANTID	VARCHAR2(10))	X	Unique participant identifier
STATUS	VARCHAR2(10))		Load status [SUCCESSFUL/CORRUPT]
ACKFILENAME	VARCHAR2(40))		Acknowledge file name
ENDDATE	DATE		Not used
FILENAME	VARCHAR2(40))	X	Load file name
LASTCHANGED	DATE		Last date and time record changed

29.65 Table: OFFERGOVDATA

29.65.1 OFFERGOVDATA

Name	OFFERGOVDATA
Comment	OFFERGOVDATA sets out reoffers of governor (6 and 60 second FCAS) availability.

29.65.2 Description

Not in Use - discontinued 30/09/2001

Confidential to participant

Source

Updated as reoffers process.

29.65.3 Primary Key Columns

Name

CONTRACTID

EFFECTIVEDATE

PERIODID

VERSIONNO

29.65.4 Index Columns

Name

LASTCHANGED

29.65.5 Index Columns

Name

CONTRACTID

29.65.6 Content

Name	Data Type	Mandatory	Comment
CONTRACTID	VARCHAR2(10)	X	Contract Version No.
EFFECTIVEDATE	DATE	X	Effective Date of Re-Offer
VERSIONNO	NUMBER(3,0)	X	Version No. of Re-Offer
PERIODID	NUMBER(3,0)	X	Market day trading interval number
SEC6AVAILUP	NUMBER(6,0)		Availability for 6 Second Raise (0 or 1. '0'= unavailable, '1' = available)
SEC6AVAILDOWN	NUMBER(6,0)		Availability for 6 Second Lower (0 or 1)
SEC60AVAILUP	NUMBER(6,0)		Availability for 60 Second Raise (0 or 1)
SEC60AVAILDOWN	NUMBER(6,0)		Availability for 60 Second Lower (0 or 1)
AUTHORISEDDATE	DATE		Date Contract was Authorised
AUTHORISEDBY	VARCHAR2(15)		User Name
FILENAME	VARCHAR2(40)		File name of Re-Offer file
LASTCHANGED	DATE		Last date and time record changed

29.66 Table: OFFERULODINGDATA

29.66.1 OFFERULODINGDATA

Name	OFFERULODINGDATA
Comment	OFFERULODINGDATA shows reoffers of rapid unit loading capability.

29.66.2 Description

Not in Use - discontinued 30/09/2001

OFFERULODINGDATA data is confidential to each participant.

Source

OFFERULODINGDATA updated as reoffers processed.

29.66.3 Primary Key Columns

Name

CONTRACTID

EFFECTIVEDATE

PERIODID

VERSIONNO

29.66.4 Index Columns

Name

LASTCHANGED

29.66.5 Index Columns

Name

CONTRACTID

29.66.6 Content

Name	Data Type	Mandatory	Comment
CONTRACTID	VARCHAR2(10)	X	Contract identifier
EFFECTIVEDATE	DATE	X	Effective date of contract
VERSIONNO	NUMBER(3,0)	X	Version No of contract
AVAILABLELOAD	NUMBER(4,0)		Available load
AUTHORISEDDATE	DATE		Authorised date
AUTHORISEDBY	VARCHAR2(15)		Authorised by
FILENAME	VARCHAR2(40)		Name of reoffer file
LASTCHANGED	DATE		Last date and time record changed
PERIODID	NUMBER(3,0)	X	Market day trading interval number

29.67 Table: OFFERUNLOADINGDATA

29.67.1 OFFERUNLOADINGDATA

Name	OFFERUNLOADINGDATA
Comment	OFFERUNLOADINGDATA shows reoffers of rapid unit unloading capability.

29.67.2 Description

Not in Use - discontinued 30/09/2001

OFFERUNLOADINGDATA data is confidential to the relevant participant.

Source

OFFERUNLOADINGDATA updates as reoffers processed.

29.67.3 Primary Key Columns

- Name
- CONTRACTID
- EFFECTIVEDATE
- PERIODID
- VERSIONNO

29.67.4 Index Columns

- Name
- LASTCHANGED

29.67.5 Index Columns

- Name

CONTRACTID

29.67.6 Content

Name	Data Type	Mandatory	Comment
CONTRACTID	VARCHAR2(10)	X	Contract identifier
EFFECTIVEDATE	DATE	X	Market date of reoffer
VERSIONNO	NUMBER(3,0)	X	Version No of reoffer
AVAILABLELOAD	NUMBER(4,0)		Available load
AUTHORISEDDATE	DATE		Authorised date
AUTHORISEDBY	VARCHAR2(15)		Authorised by
FILENAME	VARCHAR2(40)		Name of reoffer file
LASTCHANGED	DATE		Last date and time record changed
PERIODID	NUMBER(3,0)	X	Market day trading interval number

29.68 Table: PASACASESOLUTION

29.68.1 PASACASESOLUTION

Name PASACASESOLUTION

Comment PASACASESOLUTION sets out ST PASA case listing providing details of each STPASA case run.

29.68.2 Description

PASACASESOLUTION is obsolete on 27 March 2002

PASACASESOLUTION is public data, so is available to all participants.

Source

PASACASESOLUTION is not used; was updated every 2 hours.

29.68.3 Primary Key Columns

Name

CASEID

29.68.4 Index Columns

Name

LASTCHANGED

29.68.5 Content

Name	Data Type	Mandatory	Comment
CASEID	VARCHAR2(20)	X	PASA Case Identifier
SOLUTIONCOMPLETE	NUMBER(16,6)		Not used

PASAVERSION	NUMBER(27,10)		Software version identifier
EXCESSGENERATION	NUMBER(16,6)		Excess generation detected flag
DEFICITCAPACITY	NUMBER(16,6)		Deficit capacity detected flag
LASTCHANGED	DATE		Last date and time record changed
DATETIME	DATE		Scheduled date and time of the run

29.69 Table: PASACONSTRAINTSOLUTION

29.69.1 PASACONSTRAINTSOLUTION

Name	PASACONSTRAINTSOLUTION
Comment	PASACONSTRAINTSOLUTION records the latest binding STPASA constraint details for each period. For each solution, the latest recalculation for each period overwrites the previous entry.

29.69.2 Description

PASACONSTRAINTSOLUTION is obsolete on 27 March 2002

PASACONSTRAINTSOLUTION is public data, so is available to all participants.

Source

PASACONSTRAINTSOLUTION is not used; was updated every 2 hours.

29.69.3 Primary Key Columns

Name
CONSTRAINTID
PERIODID

29.69.4 Index Columns

Name
LASTCHANGED

29.69.5 Content

Name	Data Type	Mandatory	Comment
CASEID	VARCHAR2(20)	X	PASA Case Identifier

CONSTRAINTID	VARCHAR2(20)	X	Generic Constraint Id
PERIODID	VARCHAR2(20)	X	PASA Interval (48 half hours)
CAPACITYMARGINALVALUE	NUMBER(16,6)		Binding value of capacity and adequacy (if insufficient to measure)
CAPACITYVIOLATIONDEGREE	NUMBER(16,6)		Deficit MW of surplus capacity
EXCESSGENMARGINALVALUE	NUMBER(16,6)		Binding value of dispatch generator above aggregate self dispatch
EXCESSGENVIOLATIONDEGREE	NUMBER(16,6)		Deficit of generator above aggregate self dispatch level
LASTCHANGED	DATE		Last date and time record changed
DATETIME	DATE		Date and time of the end of the period

29.70 Table: PASAINTERCONNECTORSOLUTION

29.70.1 PASAINTERCONNECTORSOLUTION

Name	PASAINTERCONNECTORSOLUTION
Comment	PASAINTERCONNECTORSOLUTION records ST PASA interconnector solutions for the latest period.

29.70.2 Description

PASAINTERCONNECTORSOLUTION is obsolete on 27 March 2002

PASAINTERCONNECTORSOLUTION is public data, so is available to all participants.

Source

PASAINTERCONNECTORSOLUTION is unused; was updated every 2 hours.

29.70.3 Primary Key Columns

Name
INTERCONNECTORID
PERIODID

29.70.4 Index Columns

Name
LASTCHANGED

29.70.5 Content

Name	Data Type	Mandatory	Comment
CASEID	VARCHAR2(20)	X	PASA Case Identifier

INTERCONNECTORID	VARCHAR2(10)	X	Interconnector Id
PERIODID	VARCHAR2(20)	X	PASA Interval (48 half hours)
CAPACITYMWFLOW	NUMBER(16,6)		Capacity MW flow
CAPACITYMARGINALVALUE	NUMBER(16,6)		Marginal value in capacity
CAPACITYVIOLATIONDEGREE	NUMBER(16,6)		Violation value in capacity
EXCESSGENMWFLOW	NUMBER(16,6)		Excess generation MW flow
EXCESSGENMARGINALVALUE	NUMBER(16,6)		Marginal value in excess generation
EXCESSGENVIOLATIONDEGREE	NUMBER(16,6)		Violation value in excess generation
LASTCHANGED	DATE		Last date and time record changed
IMPORTLIMIT	NUMBER(15,5)		Calculated import limit
EXPORTLIMIT	NUMBER(15,5)		Calculated export limit
DATETIME	DATE		Date and time of the end of the period

29.71 Table: PASAREGIONSOLUTION

29.71.1 PASAREGIONSOLUTION

Name	PASAREGIONSOLUTION
Comment	PASAREGIONSOLUTION shows the Regional solution for ST PASA showing reserves for each half-hour period. This table (PASAREGIONSOLUTION_D) shows the latest calculated result for each period.

29.71.2 Description

PASAREGIONSOLUTION is obsolete on 27 March 2002.

PASAREGIONSOLUTION is public data, so is available to all participants.

Source

PASAREGIONSOLUTION is not used; was updated every 2 hours.

29.71.3 Primary Key Columns

Name
 PERIODID
 REGIONID

29.71.4 Index Columns

Name
 LASTCHANGED

29.71.5 Content

Name	Data Type	Mandatory	Comment
CASEID	VARCHAR2(20)	X	PASA Case Identifier

)		
REGIONID	VARCHAR2(10))	X	Region Identifier
PERIODID	VARCHAR2(20))	X	PASA Interval (48 half hours)
DEMAND10	NUMBER(16,6)		10% exceedence forecast
DEMAND50	NUMBER(16,6)		50% exceedence forecast
DEMAND90	NUMBER(16,6)		90% exceedence forecast
UNCONSTRAINEDCAPACITY	NUMBER(16,6)		Unconstrained capacity
CONSTRAINEDCAPACITY	NUMBER(16,6)		Constrained capacity
CAPACITYSURPLUS	NUMBER(16,6)		Surplus capacity
RESERVEREQ	NUMBER(16,6)		Reserve requirement
RESERVECONDITION	NUMBER(16,6)		Reserve condition
RESERVESURPLUS	NUMBER(16,6)		Reserve surplus
LOADREJECTIONRESERVE REQ	NUMBER(16,6)		Load rejection reserve requirement
LOADREJECTIONRESERVE SURPLUS	NUMBER(16,6)		Load rejection reserve surplus
NETINTERCHANGEUNDER EXCESS	NUMBER(16,6)		Net interchange excess
NETINTERCHANGEUNDER SCARCITY	NUMBER(16,6)		Net interchange scarcity
LASTCHANGED	DATE		Last date and time record changed
EXCESSGENERATION	NUMBER(22,0)		Excess generation in period OR Deficit generation if VoLL

ENERGYREQUIRED	NUMBER(15,5)		Total amount of energy required for the reported day
CAPACITYREQUIRED	NUMBER(15,5)		Trading interval demand for the region that has a 10% probability of being exceeded, plus the medium term capacity reserve standard.
DATETIME	DATE		Date and time of the end of the period

29.72 Table: PEROFFER

29.72.1 PEROFFER

Name	PEROFFER
Comment	<p>PEROFFER contains the half-hourly period details of daily bids and rebids, to be used in conjunction with DAYOFFER. These views provide period varying details such as rate of change up (ROCUP), rate of change down (ROCDOWN) and band quantities (BANDAVAIL from 1 to 10).</p> <p>PEROFFER is a child table of DAYOFFER.</p>

29.72.2 Description

Status

PEROFFER is obsolete. please see BIDPEROFFER. For a transition period, PEROFFER data continued to exist, being based on BIDPEROFFER.

Source

PEROFFER is obsolete; confidential data was updated for each bid and rebid, with full visibility of rest of market were updated daily as part of next day data.

29.72.3 Primary Key Columns

Name

DUID

OFFERDATE

PERIODID

SETTLEMENTDATE

VERSIONNO

29.72.4 Index Columns

Name

LASTCHANGED

29.72.5 Index Columns

Name

DUID

LASTCHANGED

29.72.6 Content

Name	Data Type	Mandatory	Comment
SETTLEMENTDATE	DATE	X	Market date starting at 04:00am
DUID	VARCHAR2(10)	X	Dispatchable Unit identifier
OFFERDATE	DATE	X	Offer date made
PERIODID	NUMBER(3,0)	X	Period identifier
VERSIONNO	NUMBER(3,0)	X	Version number of offer
SELFDISPATCH	NUMBER(12,6)		Not used
MAXAVAIL	NUMBER(12,6)		Maximum plant availability
FIXEDLOAD	NUMBER(12,6)		Fixed unit output MW. A value of zero means no fixed load so the unit is dispatched according to bid and market (rather than zero fixed load)
ROCU	NUMBER(6,0)		MW/min for raise

ROCDOWN	NUMBER(6,0)		MW/Min for lower
BANDAVAIL1	NUMBER(6,0)		Availability at price band 1
BANDAVAIL2	NUMBER(6,0)		Availability at price band 2
BANDAVAIL3	NUMBER(6,0)		Availability at price band 3
BANDAVAIL4	NUMBER(6,0)		Availability at price band 4
BANDAVAIL5	NUMBER(6,0)		Availability at price band 5
BANDAVAIL6	NUMBER(6,0)		Availability at price band 6
BANDAVAIL7	NUMBER(6,0)		Availability at price band 7
BANDAVAIL8	NUMBER(6,0)		Availability at price band 8
BANDAVAIL9	NUMBER(6,0)		Availability at price band 9
BANDAVAIL10	NUMBER(6,0)		Availability at price band 10
LASTCHANGED	DATE		Last date and time record changed
PASAAVAILABILITY	NUMBER(12,0)		The physical plant capability including any capability potentially available within 24 hours.
MR_CAPACITY	NUMBER(6,0)		Mandatory Restriction Offer amount

29.73 Table: PEROFFER_D

29.73.1 PEROFFER_D

Name PEROFFER_D

Comment PEROFFER_D contains the half-hourly period details of daily bids and rebids, to be used in conjunction with DAYOFFER_D. These views provide period varying details such as rate of change up (ROCUP), rate of change down (ROCDOWN) and band quantities (BANDAVAIL from 1 to 10).

PEROFFER_D is a child table of DAYOFFER_D.

29.73.2 Description

Not in Use - discontinued 16/11/2003

Status

PEROFFER and its related views are obsolete. please see BIDPEROFFER views. For a transition period, the PEROFFER views exist, being based on the BIDPEROFFER table.

Source

PEROFFER is obsolete; confidential data was updated for each bid and rebid, with full visibility of rest of market were updated daily as part of next day data.

29.73.3 Primary Key Columns

Name

DUID

OFFERDATE

PERIODID

SETTLEMENTDATE

VERSIONNO

29.73.4 Index Columns

Name

LASTCHANGED

29.73.5 Index Columns

Name

DUID

LASTCHANGED

29.73.6 Content

Name	Data Type	Mandatory	Comment
SETTLEMENTDATE	DATE	X	Market date starting at 04:00am
DUID	VARCHAR2(10)	X	Dispatchable Unit identifier
OFFERDATE	DATE	X	Offer date made
PERIODID	NUMBER(3,0)	X	Period identifier
VERSIONNO	NUMBER(3,0)	X	Version number of offer
SELFDISPATCH	NUMBER(12,6)		Not used
MAXAVAIL	NUMBER(12,6)		Maximum plant availability
FIXEDLOAD	NUMBER(12,6)		Fixed unit output MW. A value of zero means no fixed load so the unit is dispatched according to bid and market (rather than zero fixed load)
ROCUF	NUMBER(6,0)		MW/min for raise

ROCDOWN	NUMBER(6,0)		MW/Min for lower
BANDAVAIL1	NUMBER(6,0)		Availability at price band 1
BANDAVAIL2	NUMBER(6,0)		Availability at price band 2
BANDAVAIL3	NUMBER(6,0)		Availability at price band 3
BANDAVAIL4	NUMBER(6,0)		Availability at price band 4
BANDAVAIL5	NUMBER(6,0)		Availability at price band 5
BANDAVAIL6	NUMBER(6,0)		Availability at price band 6
BANDAVAIL7	NUMBER(6,0)		Availability at price band 7
BANDAVAIL8	NUMBER(6,0)		Availability at price band 8
BANDAVAIL9	NUMBER(6,0)		Availability at price band 9
BANDAVAIL10	NUMBER(6,0)		Availability at price band 10
LASTCHANGED	DATE		Last date and time record changed
PASAAVAILABILITY	NUMBER(12,0)		The physical plant capability including any capability potentially available within 24 hours.
MR_CAPACITY	NUMBER(6,0)		Mandatory Restriction Offer amount

29.74 Table: PREDISPATCHBIDTRK

29.74.1 PREDISPATCHBIDTRK

Name	PREDISPATCHBIDTRK
Comment	PREDISPATCHBIDTRK contains an audit trail of bids used in each predispatch run. Where predispatch is over 2 days, two bids are listed.

29.74.2 Description

Status

PREDISPATCHOFFERTRK and related views are obsolete. Please see tables and views related to BIDPEROFFER.

Source

Own (confidential) data shows via inserts with every thirty-minute predispatch. Daily update after close of day shows all market bids for the closed day.

Period date and time

29.74.3 Primary Key Columns

Name

DUID

PERIODID

PREDISPATCHSEQNO

29.74.4 Index Columns

Name

LASTCHANGED

29.74.5 Index Columns

Name

DUID

LASTCHANGED

29.74.6 Index Columns

Name

DUID

SETTLEMENTDATE

29.74.7 Content

Name	Data Type	Mandatory	Comment
PREDISPATCHSEQNO	VARCHAR2(20)	X	Unique identifier of predispatch run in the form YYYYMMDDPP with 01 at 04:30
DUID	VARCHAR2(10)	X	Dispatchable Unit identifier
PERIODID	VARCHAR2(20)	X	PERIODID is just a period count, starting from 1 for each predispatch run. Use DATETIME to determine half hour period.
BIDTYPE	VARCHAR2(10)		Bid type (daily, default or rebid)
OFFERDATE	DATE		Offer date for bid
VERSIONNO	NUMBER(3,0)		Version no of offer for the offer date
LASTCHANGED	DATE		Last date and time record changed
SETTLEMENTDATE	DATE		Market Settlement Date

DATETIME	DATE		Period date and time
----------	------	--	----------------------

29.75 Table: REALLOCATIONDETAILS

29.75.1 REALLOCATIONDETAILS

Name REALLOCATIONDETAILS

Comment REALLOCATIONDETAILS sets out specific reallocation agreements.

29.75.2 Description

Not in Use - discontinued 10/06/2004

Source

As changes occur.

29.75.3 Primary Key Columns

Name

EFFECTIVEDATE

REALLOCATIONID

VERSIONNO

29.75.4 Index Columns

Name

LASTCHANGED

29.75.5 Content

Name	Data Type	Mandatory	Comment
REALLOCATIONID	VARCHAR2(20)	X	Identification of the reallocation agreement

EFFECTIVEDATE	DATE	X	Calendar settlement date the agreement starts from
VERSIONNO	NUMBER(3,0)	X	Version number on the effective date, highest is the reallocation used on that date
AUTHORISEDDATE	DATE		Date the entry was authorised
AUTHORISEDBY	VARCHAR2(10))		User who authorised the record
LASTCHANGED	DATE		Last date and time record changed

29.76 Table: REALLOCATIONINTERVALS

29.76.1 REALLOCATIONINTERVALS

Name	REALLOCATIONINTERVALS
Comment	REALLOCATIONINTERVALS identifies the the reallocation agreement and provides the corresponding reallocation profiles submitted by the participant and accepted by AEMO

29.76.2 Description

Not in Use - discontinued 10/06/2004

Source

Only populated if a reallocation contract has been submitted and accepted by AEMO.

Volume

Generally 144 rows are inserted by week.

29.76.3 Primary Key Columns

Name
EFFECTIVEDATE
PERIODID
REALLOCATIONID
VERSIONNO

29.76.4 Index Columns

Name
LASTCHANGED

29.76.5 Content

Name	Data Type	Mandatory	Comment
REALLOCATIONID	VARCHAR2(20)	X	Identification of the reallocation agreement
EFFECTIVEDATE	DATE	X	Date the agreement starts from
VERSIONNO	NUMBER(3,0)	X	Version number on the effective date, highest is the reallocation used on that date
PERIODID	NUMBER(3,0)	X	Period number where period 1 use the half hour ended 00:30 EST
REALLOCATIONVALUE	NUMBER(6,2)		Either \$ or MWh depending on agreement type
LASTCHANGED	DATE		Last date and time record changed

29.77 Table: REALLOCATIONS

29.77.1 REALLOCATIONS

Name	REALLOCATIONS
Comment	REALLOCATIONS shows reallocation agreement identifiers with corresponding start and end dates of submitted reallocations as accepted by AEMO.

29.77.2 Description

Not in Use - discontinued 10/06/2004

Source

This view is populated upon submission of a reallocation contract and accepted by AEMO.

Volume

Generally 3 rows are inserted by week.

29.77.3 Primary Key Columns

Name	REALLOCATIONID
------	----------------

29.77.4 Index Columns

Name	LASTCHANGED
------	-------------

29.77.5 Content

Name	Data Type	Mandatory	Comment
REALLOCATIONID	VARCHAR2(20)	X	Identification of the reallocation agreement

STARTDATE	DATE		Starting data for the agreement
STARTPERIOD	NUMBER(3,0)		Starting period number
ENDDATE	DATE		Ending date for the agreement
ENDPERIOD	NUMBER(3,0)		Ending period number
PARTICIPANTTOID	VARCHAR2(10)		Participant who receives the money
PARTICIPANTFROMID	VARCHAR2(10)		Participant who provides the money
AGREEMENTTYPE	VARCHAR2(10)		Either \$ or MWh
DEREGISTRATIONDATE	DATE		Not used
DEREGISTRATIONPERIOD	NUMBER(3,0)		Not used
REGIONID	VARCHAR2(10)		Place where the RRP is taken for the agreement
LASTCHANGED	DATE		Last date and time record changed

29.78 Table: REGIONFCASRELAXATION_OCD

29.78.1 REGIONFCASRELAXATION_OCD

Name	REGIONFCASRELAXATION_OCD
Comment	<p>REGIONFCASRELAXATION_OCD contains details of regional FCAS requirements relaxed in the over-constrained dispatch (OCD) re-run (if there was one).</p> <p>Note: INTERVENTION is not included in REGIONFCASRELAXATION_OCD since the relaxation of the FCAS requirement is the same amount in both intervened and non-intervened cases.</p>

29.78.2 Description

REGIONFCASRELAXATION_OCD data is public, so is available to all participants.

Source

The occurrences of Over-constrained dispatch (OCD) re-runs are ad hoc, with significant dependencies on the configuration or events in the physical power system.

Volume

Rows per day: ~2

Mb per month: <1

The estimates on the number of rows are based on a 1% occurrence rate for OCD runs.

Note

The DISPATCHCASESOLUTION results report with the existing CASESUBTYPE field as “OCD” when detecting over-constrained dispatch.

29.78.3 Primary Key Columns

Name
GLOBAL
REGIONID
RUNNO

SERVICETYPE

SETTLEMENTDATE

29.78.4 Index Columns

Name

LASTCHANGED

29.78.5 Content

Name	Data Type	Mandatory	Comment
SETTLEMENTDATE	DATE	X	End date and time of the dispatch interval
RUNNO	NUMBER(3,0)	X	Dispatch run no
REGIONID	VARCHAR2(10)	X	Region Identifier
SERVICETYPE	VARCHAR2(10)	X	Ancillary service type identifier (e.g. LOWER60SEC)
GLOBAL	NUMBER(1,0)	X	FCAS Requirement: 1 = global, 0 = local
REQUIREMENT	NUMBER(15,5)		Relaxed Requirement used in attempt to avoid violation
LASTCHANGED	DATE		Last date and time record changed

29.79 Table: SET_CSP_DEROGATION_AMOUNT

29.79.1 SET_CSP_DEROGATION_AMOUNT

Name	SET_CSP_DEROGATION_AMOUNT
Comment	A settlement table for the publication of Snowy CSP derogation amounts.

29.79.2 Description

Source

Settlements data process is populated at the posting of a billing run in which it is included.

Volume

Estimated number of rows is 13440 for a based on the 35 settlement days posted per week. Note this data would only be delivered to the participant receiving payments from the derogation.

29.79.3 Notes

Name	Comment	Value
Visibility	Data in this table is:	Public

29.79.4 Primary Key Columns

- Name
- AMOUNT_ID
- PARTICIPANTID
- PERIODID
- SETTLEMENTDATE
- VERSIONNO

29.79.5 Index Columns

Name

LASTCHANGED

29.79.6 Content

Name	Data Type	Mandatory	Comment
SETTLEMENTDATE	DATE	X	Settlement Date
VERSIONNO	NUMBER(3)	X	Settlement run number
PERIODID	NUMBER(3)	X	Period identifier
PARTICIPANTID	VARCHAR2(10)	X	The participant allocated the payment amount for the derogation.
AMOUNT_ID	VARCHAR2(20)	X	Amount identifier represented as a string, from "TA1" through to "TA6" (or "TA8" for a LYMMCO derogation result)
DEROGATION_AMOUNT	NUMBER(18,8)		Derogation amount associated with the amount identifier
LASTCHANGED	DATE		Last changed date for the record

29.80 Table: SET_CSP_SUPPORTDATA_CONSTRAINT

29.80.1 SET_CSP_SUPPORTDATA_CONSTRAINT

Name	SET_CSP_SUPPORTDATA_CONSTRAINT
Comment	A settlements table for the publication of support data for the Snowy CSP derogation amounts. This table publishes the constraint-level information for each five minute interval in the settlement run

29.80.2 Description

Source

Settlements data process is populated at the posting of a billing run in which it is included.

Volume

Estimated number of rows is an average of 1000 per week based on the 35 settlement days posted per week.

29.80.3 Notes

Name	Comment	Value
Visibility	Data in this table is:	Public

29.80.4 Primary Key Columns

Name

CONSTRAINTID

INTERVAL_DATETIME

PERIODID

SETTLEMENTDATE

VERSIONNO

29.80.5 Index Columns

Name

LASTCHANGED

29.80.6 Content

Name	Data Type	Mandatory	Comment
SETTLEMENTDATE	DATE	X	Settlement Date
VERSIONNO	NUMBER(3)	X	Settlement run number
INTERVAL_DATETIME	DATE	X	Dispatch interval identifier
CONSTRAINTID	VARCHAR2(20)	X	Constraint identifier
PERIODID	NUMBER(3)	X	Settlements trading interval identifier
MARGINALVALUE	NUMBER(18,8)		Marginal value of the constraint
RHS	NUMBER(18,8)		RHS value of the constraint
LOWERTUMUT_FACTOR	NUMBER(18,8)		Value of the Lower Tumut left-hand term of the constraint
UPPERTUMUT_FACTOR	NUMBER(18,8)		Value of the Upper Tumut left hand term of the constraint
LOWERTUMUT_CSPA_COEFF	NUMBER(18,8)		LOWERTUMUT_FACTOR x MARGINALVALUE
UPPERTUMUT_CSPA_COEFF	NUMBER(18,8)		UPPERTUMUT_FACTOR x MARGINALVALUE
ABS_X	NUMBER(18,8)		Equal to RHS if the constraint direction is SOUTH, otherwise zero

ABS_Y	NUMBER(18,8)		Equal to RHS if the constraint direction is NORTH, otherwise zero
LASTCHANGED	DATE		Last changed date of the record

29.81 Table: SET_CSP_SUPPORTDATA_ENERGYDIFF

29.81.1 SET_CSP_SUPPORTDATA_ENERGYDIFF

Name	SET_CSP_SUPPORTDATA_ENERGYDIFF
Comment	A settlements table for the publication of support data for the Snowy CSP derogation amounts. This table publishes energy differential information for each half-hour interval in the settlement run

29.81.2 Description

THIS TABLE WILL BE DISCONTINUED AS PART OF THE END OF YEAR 2009 MMS RELEASESource

Settlements data process is populated at the posting of a billing run in which it is included.

Volume

Estimated number of rows is an average of 1000 per week based on the 35 settlement days posted per week.

29.81.3 Notes

Name	Comment	Value
Visibility	Data in this table is:	Public

29.81.4 Primary Key Columns

- Name
- PERIODID
- SETTLEMENTDATE
- VERSIONNO

29.81.5 Index Columns

Name

LASTCHANGED

29.81.6 Content

Name	Data Type	Mandatory	Comment
SETTLEMENTDATE	DATE	X	Settlement Date
VERSIONNO	NUMBER(3)	X	Settlement run number
PERIODID	NUMBER(3)	X	Period identifier
LOWERTUMUT_SPDP	NUMBER(18,8)		Lower Tumut Substitute Price for the half hour interval
UPPERTUMUT_SPDP	NUMBER(18,8)		Upper Tumut Substitute Price for the half hour interval
LOWERTUMUT_EVDP	NUMBER(18,8)		Lower Tumut Energy Value Differential for the half hour interval
UPPERTUMUT_EVDP	NUMBER(18,8)		Upper Tumut Energy Value Differential for the half hour interval
FLOW_DIRECTION	VARCHAR2(20)		Indicates the determined direction of flow in the half hour. Will be either "NORTH" or "SOUTH"
TOTAL_X	NUMBER(18,8)		Sum of all "ABS_X" values in the half hour
TOTAL_Y	NUMBER(18,8)		Sum of all "ABS_Y" values in the half hour
LOWERTUMUT_AGE	NUMBER(18,8)		Energy output of the Lower Tumut

			unit in the half hour interval
UPPERTUMUT_AGE	NUMBER(18,8)		Energy output of the Upper Tumut unit in the half hour interval
EVA	NUMBER(18,8)		Energy value adjustment for northward flows in the half-hour interval
LASTCHANGED	DATE		Last changed date for the record

29.82 Table: SET_CSP_SUPPORTDATA_SUBPRICE

29.82.1 SET_CSP_SUPPORTDATA_SUBPRICE

Name	SET_CSP_SUPPORTDATA_SUBPRICE
Comment	A settlements table for the publication of support data for the Snowy CSP derogation amounts. This table publishes substitution price information for each five minute interval in the settlement run

29.82.2 Description

Source

Settlements data process is populated at the posting of a billing run in which it is included.

Volume

Estimated number of rows is an average of 1000 per week based on the 35 settlement days posted per week.

29.82.3 Notes

Name	Comment	Value
Visibility	Data in this table is:	Public

29.82.4 Primary Key Columns

Name

INTERVAL_DATETIME

SETTLEMENTDATE

VERSIONNO

29.82.5 Index Columns

Name

LASTCHANGED

29.82.6 Content

Name	Data Type	Mandatory	Comment
SETTLEMENTDATE	DATE	X	Settlement Date
VERSIONNO	NUMBER(3)	X	Settlement run number
INTERVAL_DATETIME	DATE	X	Dispatch interval identifier
PERIODID	NUMBER(3)		Period identifier
RRP	NUMBER(18,8)		SNOWY1 RRP for the dispatch interval
IS_CSP_INTERVAL	NUMBER(1)		A flag to indicate whether a binding CSP constraint was present in the dispatch interval. A value of 1 indicates that CSP processing occurred due to a binding CSP constraint, while a value of 0 indicates that no binding CSP constraints were present in this interval
LOWERTUMUT_TLF	NUMBER(18,8)		Transmission loss factor of the Lower Tumut unit
UPPERTUMUT_TLF	NUMBER(18,8)		Transmission Loss factor of the Upper Tumut unit
LOWERTUMUT_PRICE	NUMBER(18,8)		The dispatch price at the Lower Tumut node
UPPERTUMUT_PRICE	NUMBER(18,8)		The dispatch price at the Upper Tumut node
LOWERTUMUT_CSPA_COE	NUMBER(18,8)		Sum of CSPAxCOEFF for all

FF			constraints and Lower Tumut left-hand terms
UPPERTUMUT_CSPA_COEFF	NUMBER(18,8)		Sum of CSPAxCOEFF for all constraints and Upper Tumut left-hand terms
LOWERTUMUT_SPDP_UNCAPPED	NUMBER(18,8)		LOWERTUMUT_SPDP before VOLL or MPF capping is applied
UPPERTUMUT_SPDP_UNCAPPED	NUMBER(18,8)		UPPERTUMUT_SPDP before VOLL or MPF capping is applied
LOWERTUMUT_SPDP	NUMBER(18,8)		Substitute Price for Lower Tumut
UPPERTUMUT_SPDP	NUMBER(18,8)		Substitute Price for Upper Tumut
INTERVAL_ABS_X	NUMBER(18,8)		Sum of all ABS_X values for binding CSP constraints in the dispatch interval
INTERVAL_ABS_Y	NUMBER(18,8)		Sum of all ABS_Y values for binding CSP constraints in the dispatch interval
LASTCHANGED	DATE		Last changed date for the record

29.83 Table: SETAPCCOMPENSATION

29.83.1 SETAPCCOMPENSATION

Name	SETAPCCOMPENSATION
Comment	SETAPCCOMPENSATION shows Administered Price Cap (APC) compensation payments for each period.

29.83.2 Description

SETAPCCOMPENSATION data is confidential to the relevant participant.

Source

SETAPCCOMPENSATION updates in settlement runs, as needed.

29.83.3 Notes

Name	Comment	Value
Visibility	Data in this table is:	Private

29.83.4 Primary Key Columns

- Name
- PARTICIPANTID
- PERIODID
- REGIONID
- SETTLEMENTDATE
- VERSIONNO

29.83.5 Index Columns

- Name

LASTCHANGED

29.83.6 Content

Name	Data Type	Mandatory	Comment
SETTLEMENTDATE	DATE	X	Calendar Settlement Date
VERSIONNO	NUMBER(3,0)	X	Settlement run number
PARTICIPANTID	VARCHAR2(10)	X	Participant identifier
REGIONID	VARCHAR2(10)	X	Region Identifier
PERIODID	NUMBER(3,0)	X	Settlement period (based on calendar day)
APCCOMPENSATION	NUMBER(15,5)		APC amount
LASTCHANGED	DATE		Last date and time record changed

29.84 Table: SETAPCRECOVERY

29.84.1 SETAPCRECOVERY

Name	SETAPCRECOVERY
Comment	SETAPCRECOVERY shows reimbursements for Administered Price Cap (APC) to be recovered from participants.

29.84.2 Description

SETAPCRECOVERY data is confidential to the relevant participant.

Source

SETAPCRECOVERY updates with each settlement run.

29.84.3 Notes

Name	Comment	Value
Visibility	Data in this table is:	Private

29.84.4 Primary Key Columns

Name

PARTICIPANTID

PERIODID

REGIONID

SETTLEMENTDATE

VERSIONNO

29.84.5 Index Columns

Name

LASTCHANGED

29.84.6 Content

Name	Data Type	Mandatory	Comment
SETTLEMENTDATE	DATE	X	Calendar Settlement Date
VERSIONNO	NUMBER(3,0)	X	Settlement run number
PARTICIPANTID	VARCHAR2(10)	X	Participant identifier
REGIONID	VARCHAR2(10)	X	Region Identifier
PERIODID	NUMBER(3,0)	X	Settlement period (based on calendar day)
TOTALCOMPENSATION	NUMBER(15,5)		Total compensation
PARTICIPANTDEMAND	NUMBER(15,5)		Participant MW Demand
REGIONDEMAND	NUMBER(15,5)		Total region demand
APCRECOVERY	NUMBER(15,5)		APC Recovery amount
LASTCHANGED	DATE		Last date and time record changed

29.85 Table: SETFCASRECOVERY

29.85.1 SETFCASRECOVERY

Name	SETFCASRECOVERY
Comment	SETFCASRECOVERY shows reimbursements for the Frequency Control Ancillary Services compensation.

29.85.2 Description

Status

SETFCASRECOVERY is obsolete since the implementation of Ancillary Services Review. For more details, see Change Notice 126.

Confidential to the participant

Source

This view is updated with each Settlement run.

29.85.3 Notes

Name	Comment	Value
Visibility	Data in this table is:	Private

29.85.4 Primary Key Columns

- Name
- PARTICIPANTID
- PERIODID
- REGIONID
- SETTLEMENTDATE
- VERSIONNO

29.85.5 Index Columns

Name

LASTCHANGED

29.85.6 Content

Name	Data Type	Mandatory	Comment
SETTLEMENTDATE	DATE	X	Calendar Settlement Date
VERSIONNO	NUMBER(3,0)	X	Settlement run no
DUID	VARCHAR2(10)		Dispatchable Unit identifier
PARTICIPANTID	VARCHAR2(10)	X	Participant to pay recovery
REGIONID	VARCHAR2(10)	X	Region Identifier
PERIODID	NUMBER(3,0)	X	Settlement Period identifier
FCASCOMP	NUMBER(15,5)		Frequency Control Ancillary Service Compensation Payment
PARTICIPANTDEMAND	NUMBER(15,5)		Participant Demand in Region
REGIONDEMAND	NUMBER(15,5)		Total Regional demand
FCASRECOVERY	NUMBER(15,5)		Frequency Control Ancillary Service recovery amount.
LASTCHANGED	DATE		Date and Time last changed
FCASRECOVERY_GEN	NUMBER(15,5)		Frequency Control Ancillary Service recovery amount for Generator

PARTICIPANTDEMAND_GEN	NUMBER(15,5)		Participant Demand in Region for Generator
REGIONDEMAND_GEN	NUMBER(15,5)		Total Regional Demand for Generator

29.86 Table: SETGOVPAYMENT

29.86.1 SETGOVPAYMENT

Name	SETGOVPAYMENT
Comment	SETGOVPAYMENT shows specific payment details for Governor services by period.

29.86.2 Description

SETGOVPAYMENT is planned to become unused when Ancillary Services Review is implemented. For more details, see Change Notice 126 (1 Sep 2000), Change Notice 126a (18 Sep 2000) and any subsequent Change Notices with the same number.

SETGOVPAYMENT data is confidential to each participant.

Frequency and source

SETGOVPAYMENT updates with each settlement run.

29.86.3 Notes

Name	Comment	Value
Visibility	Data in this table is:	Private

29.86.4 Primary Key Columns

- Name
- CONTRACTID
- PARTICIPANTID
- PERIODID
- SETTLEMENTDATE
- VERSIONNO

29.86.5 Index Columns

Name

LASTCHANGED

29.86.6 Index Columns

Name

PARTICIPANTID

29.86.7 Content

Name	Data Type	Mandatory	Comment
SETTLEMENTDATE	DATE	X	Settlement Date
VERSIONNO	NUMBER(3,0)	X	Settlement Run No.
PARTICIPANTID	VARCHAR2(10)	X	Unique participant identifier
CONTRACTID	VARCHAR2(10)	X	Contract Identifier
PERIODID	NUMBER(3,0)	X	Period Identifier
DUID	VARCHAR2(10)		Dispatchable Unit ID
REGIONID	VARCHAR2(10)		Region Identifier
TLF	NUMBER(7,5)		Transmission Loss Factor of Unit
RL6SECRAISE	NUMBER(15,5)		contract enabling price - 6 sec raise
RL60SECRAISE	NUMBER(15,5)		contract enabling price - 60 sec

			raise
RL6SECLOWER	NUMBER(15,5)		contract enabling price - 6 sec lower
RL60SECLOWER	NUMBER(15,5)		contract enabling price - 60 sec lower
DEADBANDUP	NUMBER(7,5)		contracted dead band up
DEADBANDDOWN	NUMBER(7,5)		contracted dead band down
R6	NUMBER(15,5)		6 sec raise response for 1% deviation in frequency (droop equation)
R60	NUMBER(15,5)		60 sec raise response for 1% deviation in frequency (droop equation)
L6	NUMBER(15,5)		6 sec lower response for 1% deviation in frequency (droop equation)
L60	NUMBER(15,5)		60 sec lower response for 1% deviation in frequency (droop equation)
RL6	NUMBER(15,5)		6 sec raise response limit equation
RL60	NUMBER(15,5)		60 sec raise response limit equation
LL6	NUMBER(15,5)		6 sec lower response limit equation
LL60	NUMBER(15,5)		6 sec lower response limit equation
ENABLING6RPAYMENT	NUMBER(15,5)		6 sec raise enabling payment
ENABLING60RPAYMENT	NUMBER(15,5)		60 sec raise enabling payment
ENABLING6LPAYMENT	NUMBER(15,5)		6 sec lower enabling payment

ENABLING60LPAYMENT	NUMBER(15,5)		60 sec lower enabling payment
CONTRACTVERSIONNO	NUMBER(3,0)		AS contract version no
OFFERDATE	DATE		re-offer offer date
OFFERVERSIONNO	NUMBER(3,0)		re-offer offer version
LASTCHANGED	DATE		Last date and time record changed

29.87 Table: SETGOVRECOVERY

29.87.1 SETGOVRECOVERY

Name	SETGOVRECOVERY
Comment	SETGOVRECOVERY shows reimbursements for the Governor Ancillary Services to be recovered from participants.

29.87.2 Description

SETGOVRECOVERY became unused when Ancillary Services Review was implemented. For more details, see Change Notice 126.

SETGOVRECOVERY data is confidential to each participant.

Source

SETGOVRECOVERY updates with each settlement run.

29.87.3 Notes

Name	Comment	Value
Visibility	Data in this table is:	Private

29.87.4 Primary Key Columns

- Name
- PARTICIPANTID
- PERIODID
- REGIONID
- SETTLEMENTDATE
- VERSIONNO

29.87.5 Index Columns

Name

LASTCHANGED

29.87.6 Content

Name	Data Type	Mandatory	Comment
SETTLEMENTDATE	DATE	X	Settlement Date
VERSIONNO	NUMBER(3,0)	X	Settlement Run No.
PARTICIPANTID	VARCHAR2(10)	X	Participant to pay recovery
CONTRACTID	VARCHAR2(10)		
PERIODID	NUMBER(3,0)	X	Trading Interval
REGIONID	VARCHAR2(10)	X	Region Identifier
ENABLING6RPAYMENT	NUMBER(15,5)		Enabling Payment 6 Second Raise
ENABLING60RPAYMENT	NUMBER(15,5)		Enabling Payment 60 Second Raise
ENABLING6LPAYMENT	NUMBER(15,5)		Enabling Payment 6 Second Lower
ENABLING60LPAYMENT	NUMBER(15,5)		Enabling Payment 60 Second Lower
PARTICIPANTDEMAND	NUMBER(15,5)		Participant Demand in Region
REGIONDEMAND	NUMBER(15,5)		Total Regional Demand
ENABLING6RRECOVERY	NUMBER(15,5)		Enabling Recovery 6 Second Raise
ENABLING60RRECOVERY	NUMBER(15,5)		Enabling Recovery 60 Second Raise

ENABLING6LRECOVERY	NUMBER(15,5)		Enabling Recovery 6 Second Lower
ENABLING60LRECOVERY	NUMBER(15,5)		Enabling Recovery 60 Second Lower
LASTCHANGED	DATE		Last date and time record changed
ENABLING6LRECOVERY_GEN	NUMBER(15,5)		Enabling Recovery 6 Second Lower for Generator
ENABLING6RRECOVERY_GEN	NUMBER(15,5)		Enabling Recovery 6 Second Raise for Generator
ENABLING60LRECOVERY_GEN	NUMBER(15,5)		Enabling Recovery 60 Second Lower for Generator
ENABLING60RRECOVERY_GEN	NUMBER(15,5)		Enabling Recovery 60 Second Raise for Generator
PARTICIPANTDEMAND_GEN	NUMBER(15,5)		Participant Demand in Region for Generator
REGIONDEMAND_GEN	NUMBER(15,5)		Total Regional Demand for Generator

29.88 Table: SETLULOADPAYMENT

29.88.1 SETLULOADPAYMENT

Name	SETLULOADPAYMENT
Comment	SETLULOADPAYMENT shows specific payment details for rapid unit load services by period.

29.88.2 Description

SETLULOADPAYMENT became unused when Ancillary Services Review was implemented. For more details, see Change Notice 126.

SETLULOADPAYMENT data is confidential to each participant.

Source

SETLULOADPAYMENT is unused; was updated with each settlement run.

29.88.3 Notes

Name	Comment	Value
Visibility	Data in this table is:	Private

29.88.4 Primary Key Columns

- Name
- CONTRACTID
- PARTICIPANTID
- PERIODID
- SETTLEMENTDATE
- VERSIONNO

29.88.5 Index Columns

Name

LASTCHANGED

29.88.6 Index Columns

Name

PARTICIPANTID

29.88.7 Content

Name	Data Type	Mandatory	Comment
SETTLEMENTDATE	DATE	X	Settlement Date
VERSIONNO	NUMBER(3,0)	X	Settlement Run No.
PARTICIPANTID	VARCHAR2(10)	X	Participant Identifier
CONTRACTID	VARCHAR2(10)	X	AS Contract Identifier
PERIODID	NUMBER(3,0)	X	Trading Interval
DUID	VARCHAR2(10)		Dispatchable Unit Identifier
REGIONID	VARCHAR2(10)		Region Identifier
TLF	NUMBER(7,5)		Transmission Loss Factor
EBP	NUMBER(15,5)		Eligible Bid Price
RRP	NUMBER(15,5)		Regional Reference Price

ENABLINGPRICE	NUMBER(15,5)		Enabling Price
USAGEPRICE	NUMBER(15,5)		Usage Price
CCPRICE	NUMBER(15,5)		Compensation Cap
BLOCKSIZE	NUMBER(4,0)		Indicates how much of the unit at one given time is available for the ancillary service.
ACR	NUMBER(6,2)		Dispatch target
UNITOUTPUT	NUMBER(15,5)		Unit output.
UNITEXCESSGEN	NUMBER(15,5)		Excess Generation
ENABLINGPAYMENT	NUMBER(15,5)		Enabling Payment
USAGEPAYMENT	NUMBER(15,5)		Usage Payment
COMPENSATIONPAYMENT	NUMBER(15,5)		Compensation Payment
CONTRACTVERSIONNO	NUMBER(3,0)		Contract Version No.
OFFERDATE	DATE		Re-offer offer date
OFFERVERSIONNO	NUMBER(3,0)		Re-Offer Version No.
LASTCHANGED	DATE		Last date and time record changed

29.89 Table: SETRESERVETRADER

29.89.1 SETRESERVETRADER

Name	SETRESERVETRADER
Comment	SETRESERVETRADER shows reserve trader details.

29.89.2 Description

SETRESERVETRADER data is confidential to the relevant participant.

Source

SETRESERVETRADER updates when reserve trading occurs in a billing run, such as during an Administered Price Cap event. SETRESERVETRADER is empty until such an event occurs.

29.89.3 Notes

Name	Comment	Value
Visibility	Data in this table is:	Private

29.89.4 Primary Key Columns

- Name
- DUID
- PERIODID
- SETTLEMENTDATE
- VERSIONNO

29.89.5 Index Columns

- Name
- LASTCHANGED

29.89.6 Content

Name	Data Type	Mandatory	Comment
SETTLEMENTDATE	DATE	X	Settlement Date
VERSIONNO	NUMBER(3,0)	X	Settlement Run No.
PERIODID	NUMBER(3,0)	X	Period Identifier
CONTRACTID	VARCHAR2(10)		Reserve Trader Contract Identifier
CONTRACTVERSION	NUMBER(3,0)		Reserve Trader Contract Version
PARTICIPANTID	VARCHAR2(10)		Unique participant identifier
REGIONID	VARCHAR2(10)		Region Identifier
DUID	VARCHAR2(10)	X	Dispatchable Unit ID
RCF	CHAR(1)		Reserve Recovery Flag
UNITAVAIL	NUMBER(6,2)		Offered Availability of Unit
CPA	NUMBER(12,5)		Contract Availability Payment
CPE	NUMBER(12,5)		Contract Enabling Payment
CPU	NUMBER(12,5)		Contract Usage Payment
CPTOTAL	NUMBER(12,5)		Total Payment for Contract
CAPDIFFERENCE	NUMBER(12,5)		Spot payment applicable to the capacity above the enabling threshold
LASTCHANGED	DATE		Last date and time record changed

29.90 Table: STPASA_SYSTEMSOLUTION

29.90.1 STPASA_SYSTEMSOLUTION

Name	STPASA_SYSTEMSOLUTION
Comment	STPASA_SYSTEMSOLUTION is obsolete from 2005 End of Year Release. For solution information, see Region solution tables. STPASA_SYSTEMSOLUTION showed the results of the system capacity evaluations for each interval of the study.

29.90.2 Description

STPASA_SYSTEMSOLUTION is public data.

Source

STPASA_SYSTEMSOLUTION is updated each STPASA run (half-hourly).

Volume

Rows per day: 48

Mb per month: <1

29.90.3 Notes

Name	Comment	Value
Visibility	Data in this table is:	Public

29.90.4 Primary Key Columns

Name
INTERVAL_DATETIME

29.90.5 Index Columns

Name
LASTCHANGED

29.90.6 Index Columns

Name

RUN_DATETIME

29.90.7 Content

Name	Data Type	Mandatory	Comment
RUN_DATETIME	DATE	X	Unique Timestamp Identifier for this study
INTERVAL_DATETIME	DATE	X	The unique identifier for the interval within this study
SYSTEMDEMAND50	NUMBER(12,2)		Sum of Demand 50% PoE
RESERVEREQ	NUMBER(12,2)		System total reserve requirement
UNCONSTRAINEDCAPACITY	NUMBER(12,2)		System energy unconstrained capacity MW subject to energy and network constraints
CONSTRAINEDCAPACITY	NUMBER(12,2)		System energy constrained capacity MW subject to energy and network constraints
SURPLUSCAPACITY	NUMBER(12,2)		System capacity surplus MW, +/- values indicate surplus/deficit capacity
SURPLUSRESERVE	NUMBER(12,2)		System reserve surplus MW, +/- values indicate surplus/deficit reserve
RESERVECONDITION	NUMBER(1,0)		The system reserve condition: 0 Adequate, 1 LRC

LASTCHANGED	DATE		Last changed date of this record
-------------	------	--	----------------------------------

29.91 Table: STPASA_UNITSOLUTION

29.91.1 STPASA_UNITSOLUTION

Name	STPASA_UNITSOLUTION
Comment	STPASA_UNITSOLUTION shows the unit results from the capacity evaluations for each period of the study.

29.91.2 Description

STPASA_UNITSOLUTION was discontinued in the End Year 2005 MMS Release. See Change Notice 512c for further details.

STPASA_UNITSOLUTION is confidential data.

Source

STPASA_UNITSOLUTION is updated each STPASA run (i.e. every 2 hours).

29.91.3 Notes

Name	Comment	Value
Visibility	Data in this table is:	Private

29.91.4 Primary Key Columns

- Name
- DUID
- INTERVAL_DATETIME
- RUN_DATETIME
- RUNTYPE

29.91.5 Index Columns

Name

LASTCHANGED

29.91.6 Content

Name	Data Type	Mandatory	Comment
RUN_DATETIME	DATE	X	Unique Timestamp Identifier for this study
INTERVAL_DATETIME	DATE	X	The unique identifier for the interval within this study
DUID	VARCHAR2(10)	X	Dispatchable unit Identifier
CONNECTIONPOINTID	VARCHAR2(10)		Connection point identifier
EXPECTEDMAXCAPACITY	NUMBER(12,2)		Max MW capacity that can be obtained in case of capacity scarcity from units subject to network and energy constraints.
CAPACITYMARGINALVALUE	NUMBER(12,2)		Capacity adequacy assessment marginal value, 0 if not binding
CAPACITYVIOLATIONDEGREE	NUMBER(12,2)		Capacity adequacy assessment violation degree for unit capacity; 0 if not violating
CAPACITYAVAILABLE	NUMBER(12,2)		The available MW capacity for the period
ENERGYCONSTRAINED	NUMBER(1,0)		0 if not energy constrained, 1 if energy constrained for this energy block

ENERGYAVAILABLE	NUMBER(10,0)		The energy limit (MWH) over this energy block for the energy constrained unit
LASTCHANGED	DATE		Last changed date of this record
PASAAVAILABILITY	NUMBER(12,0)		The physical plant capability including any capability that can be made available within 24 hrs
RUNTYPE	VARCHAR2(20)	X	Type of run. Values are RELIABILITY_LRC and OUTAGE_LRC

30 Package: PDPASA

Name PDPASA

Comment The PDPASA package provides a 30-minute solving process to the Market systems

The current methodology for calculating reserves in the PreDispatch timeframe is determined in a post processing step using a heuristic calculation based the results and Interconnector limits from the PreDispatch run.

The calculation is a reserve assessment based on the PASA solver similar to existing ST and MT PASA business processes

The process reflects all intra-regional and inter-regional network constraints as an input to the process

30.1 List of tables

Name	Comment
PDPASA_CASESOLUTION	The top-level table identifying a PDPASA case, reporting options applied in the case and summary results
PDPASA_REGIONSOLUTION	The PDPASA region solution data

30.2 Diagram: Entities: PD PASA

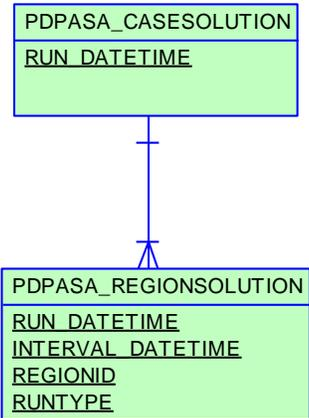

30.3 Table: PDPASA_CASESOLUTION

30.3.1 PDPASA_CASESOLUTION

Name	PDPASA_CASESOLUTION
Comment	The top-level table identifying a PDPASA case, reporting options applied in the case and summary results

30.3.2 Description

PDPASA_CASESOLUTION is public data.

Source

PDPASA_CASESOLUTION is updated each PDPASA run (i.e. half-hourly).

Volume

Rows per day: 48

Mb per month: <1

30.3.3 Notes

Name	Comment	Value
Visibility	Data in this table is:	Public

30.3.4 Primary Key Columns

Name
RUN_DATETIME

30.3.5 Index Columns

Name
LASTCHANGED

30.3.6 Content

Name	Data Type	Mandatory	Comment
RUN_DATETIME	DATE	X	Case identifier by the time the case was run
PASAVERSION	VARCHAR2(10)		Version of the PASA solver used to solve this case
RESERVECONDITION	NUMBER(1,0)		Low Reserve Condition (LRC) flag for the case (1 - LRC in the case, 0 - No LRCs in the case) for capacity run
LORCONDITION	NUMBER(1,0)		Lack of Reserve Condition (LOR) flag for the case indicates the most severe condition in the case (3 = LOR3, 2 = LOR2, 1 = LOR1, 0 = No LOR)
CAPACITYOBJFUNCTION	NUMBER(12,3)		Objective Function from the Capacity Adequacy run
CAPACITYOPTION	NUMBER(12,3)		Not populated as of 2005 End of Year Release; was the Probability of Exceedance (POE) demand forecast used for capacity adequacy (LRC) assessment. 0 if no assessment, 1 for 10% POE, 2 for 50% POE, 3 for 90% POE.
MAXSURPLUSRESERVEOPTION	NUMBER(12,3)		Not populated as of 2005 End of Year Release; was the Probability of Exceedance (POE) demand forecast used for assessment of Maximum surplus Reserve. 0 if no assessment, 1 for 10% POE, 2 for 50% POE, 3 for 90% POE
MAXSPARECAPACITYOPTI	NUMBER(12,3)		Not populated as of 2005 End of

ON			Year Release; was the Probability of Exceedance (POE) demand forecast used for assessment of Maximum Spare Capacity. 0 if no assessment, 1 for 10% POE, 2 for 50% POE, 3 for 90% POE
INTERCONNECTORFLOWPENALTY	NUMBER(12,3)		The penalty for non-zero interconnector flow
LASTCHANGED	DATE		Date and time the record was created or modified
RELIABILITYLRCDEMANDOPTION	NUMBER(12,3)		Specifies the Probability of Exceedance (POE) demand forecast for Reliability LRC assessment (0 if no assessment, 10 for 10%, 50 for 50%, 90 for 90%)
OUTAGELRCDEMANDOPTION	NUMBER(12,3)		Specifies the Probability of Exceedance (POE) demand forecast for outage LRC assessment (0 if no assessment, 10 for 10%, 50 for 50%, 90 for 90%)
LORDEMANDOPTION	NUMBER(12,3)		Specifies the Probability of Exceedance (POE) demand forecast for LOR assessment (0 if no assessment, 10 for 10%, 50 for 50%, 90 for 90%)
RELIABILITYLRCCAPACITYOPTION	VARCHAR2(10)		Generation Availability to be used in Reliability LRC run (either PASA or MARKET)
OUTAGELRCCAPACITYOPTION	VARCHAR2(10)		Generation Availability to be used in Outage LRC run (either PASA or MARKET)
LORCAPACITYOPTION	VARCHAR2(10)		Generation Availability to be used in LOR run (either PASA or

			MARKET)
LORUIGFOption	NUMBER(3,0)		UIGF POE forecast availability used for this option
ReliabilityLRCUIGFOption	NUMBER(3,0)		UIGF POE forecast availability used for this option
OutageLRCUIGFOption	NUMBER(3,0)		UIGF POE forecast availability used for this option

30.4 Table: PDPASA_REGIONSOLUTION

30.4.1 PDPASA_REGIONSOLUTION

Name	PDPASA_REGIONSOLUTION
Comment	The PDPASA region solution data

30.4.2 Description

PDPASA_REGIONSOLUTION is public so is available to all participants.

Source

PDPASA_REGIONSOLUTION is updated each PDPASA run (i.e. half-hourly).

Volume

Rows per day: 32000

Notes

LRC Determination

SURPLUSRESERVE is the surplus reserve in a region based on meeting the demand plus the reserve requirement in all regions simultaneously. Note that any surplus above the network restrictions and system reserve requirements is reported in the region it is generated, thus a surplus of zero can mean that a region is importing to meet a requirement or that it has exported all surplus to meet an adjacent region's requirement.

The PASA processes also calculate a regionally optimised surplus called the Maximum LRC Surplus (MAXSURPLUSRESERVE) being a figure on how much generation could be brought to this region subject to meeting requirements in other regions.

LOR Determination

MAXSPARECAPACITY is a regionally optimised figure representing the surplus generation able to be brought to a region subject to meeting the demand in all other regions.

Participants are directed to the first half hour of the Predispatch PASA (PDPASA) reports as NEMMCO's latest reserve determination for a given half hour.

30.4.3 Notes

Name	Comment	Value
Visibility	Data in this table is:	Public

30.4.4 Primary Key Columns

Name

INTERVAL_DATETIME

REGIONID

RUN_DATETIME

RUNTYPE

30.4.5 Index Columns

Name

LASTCHANGED

30.4.6 Content

Name	Data Type	Mandatory	Comment
RUN_DATETIME	DATE	X	Case identifier by the time the case was run
INTERVAL_DATETIME	DATE	X	End date time of the interval
REGIONID	VARCHAR2(10)	X	Region identifier
DEMAND10	NUMBER(12,2)		10% Probability of Exceedance demand forecast
DEMAND50	NUMBER(12,2)		50% Probability of Exceedance demand forecast
DEMAND90	NUMBER(12,2)		90% Probability of Exceedance demand forecast
RESERVEREQ	NUMBER(12,2)		Region reserve requirement (MW)

CAPACITYREQ	NUMBER(12,2)		Capacity required to meet the demand and reserve levels in the capacity adequacy assessment.
ENERGYREQDEMAND50	NUMBER(12,2)		Energy (GWh) required for this energy block based on the 50% probability of exceedance demand. Listed in the first interval of the energy block.
UNCONSTRAINEDCAPACITY	NUMBER(12,0)		Aggregate generator capability from Non Energy Constrained plant including restrictions due to network constraints from the capacity adequacy (LRC) assessment.
CONSTRAINEDCAPACITY	NUMBER(12,0)		Aggregate generator capability from Energy Constrained plant including restrictions due to network constraints
NETINTERCHANGEUNDER SCARCITY	NUMBER(12,2)		Net interconnector flow from the region for this interval from the capacity adequacy (LRC) assessment.
SURPLUSCAPACITY	NUMBER(12,2)		Surplus capacity (MW) above the demand, scheduled load and net interchange in this region from the capacity adequacy (LRC) assessment.
SURPLUSRESERVE	NUMBER(12,2)		Surplus reserve (MW) above the demand, scheduled load, net interchange and reserve requirement in this region from the capacity adequacy (LRC) assessment.
RESERVECONDITION	NUMBER(1,0)		Low Reserve Condition (LRC) flag

			for this region in this interval (1 - LRC, 0 - No LRC)
MAXSURPLUSRESERVE	NUMBER(12,2)		Maximum surplus reserve (MW) above the demand + reserve requirement able to be sourced to this region while meeting demand + reserve requirements in other regions.
MAXSPARECAPACITY	NUMBER(12,2)		Maximum spare capacity (MW) above the demand able to be sourced to this region while meeting demands in other regions.
LORCONDITION	NUMBER(1,0)		Lack of Reserve Condition (LOR) flag for this region and interval (3 = LOR3, 2 = LOR2, 1 = LOR1, 0 = No LOR)
AGGREGATECAPACITYAVAILABLE	NUMBER(12,2)		Sum of MAXAVAIL quantities offered by all Scheduled Generators in a given Region for a given PERIODID.
AGGREGATESCHEDULEDLOAD	NUMBER(12,2)		Sum of MAXAVAIL quantities bid by of all Scheduled Loads in a given Region for a given PERIODID.
LASTCHANGED	DATE		Date time the record was created or modified changed
AGGREGATEPASAAVAILABLE	NUMBER(12,0)		Sum of PASAAVAILABILITY quantities offered by all Scheduled Generators in a given Region for a given PERIODID.
RUNTYPE	VARCHAR2(20)	X	Type of run. Values are RELIABILITY_LRC and OUTAGE_LRC
ENERGYREQDEMAND10	NUMBER(12,2)		Energy (GWh) required for this

			energy block based on the 10% probability of exceedance demand. Listed in the first interval of the energy block
CALCULATEDLOR1LEVEL	NUMBER(16,6)		Region Reserve Level for LOR1 used. Can be static value or calculated value if an interconnector is a credible contingency
CALCULATEDLOR2LEVEL	NUMBER(16,6)		Region Reserve Level for LOR2 used. Can be static value or calculated value if an interconnector is a credible contingency
MSRNETINTERCHANGEUN DERSCARCITY	NUMBER(12,2)		Net interconnector flow from the region for this interval from the MSR assessment
LORNETINTERCHANGEUN DERSCARCITY	NUMBER(12,2)		Net interconnector flow from the region for this interval from the LOR assessment
TOTALINTERMITTENTGENE RATION	NUMBER(15,5)		Allowance made for non-scheduled generation in the demand forecast (MW).
DEMAND_AND_NONSCHE DGEN	NUMBER(15,5)		Sum of Cleared Scheduled generation, imported generation (at the region boundary) and allowances made for non-scheduled generation (MW).
UIGF	NUMBER(12,2)		Regional aggregated Unconstrained Intermittent Generation Forecast of Semi-scheduled generation (MW).
SemiScheduledCapacity	NUMBER(12,2)		Aggregate Regional UIGF

			availability
LOR_SemiScheduledCapacity	NUMBER(12,2)		Aggregate Regional UIGF availability for LOR
LCR	NUMBER(16,6)		Largest Credible Risk. MW value for highest credible contingency
LCR2	NUMBER(16,6)		Two Largest Creditable Risks. MW value for highest two credible contingencies.
FUM	NUMBER(16,6)		Forecasting Uncertainty Measure. MW value of reserve calculated as defined in the Reserve Level Declaration Guidelines
SS_SOLAR_UIGF	Number(12,2)		Regional aggregated Unconstrained Intermittent Generation Forecast of Semi-scheduled generation (MW) where the primary fuel source is solar
SS_WIND_UIGF	Number (12,2)		Regional aggregated Unconstrained Intermittent Generation Forecast of Semi-scheduled generation (MW) where the primary fuel source is wind
SS_SOLAR_CAPACITY	Number (12,2)		Regional aggregated Semi-scheduled UIGF availability where the primary fuel source is solar
SS_WIND_CAPACITY	Number (12,2)		Regional aggregated Semi-scheduled UIGF availability where the primary fuel source is wind
SS_SOLAR_CLEARED	Number (12,2)		Regional aggregated Semi-scheduled cleared MW where the primary fuel source is solar and StudyRegion = Region

SS_WIND_CLEARED	Number (12,2)		Regional aggregated Semi-scheduled cleared MW where the primary fuel source is wind and StudyRegion = Region
-----------------	---------------	--	--

31 Package: PRUDENTIALS

Name PRUDENTIALS
Comment Prudential Management

31.1 List of tables

Name	Comment
PRUDENTIALCOMPANYPOSITION	The prudential position of each company as at the datetime of a specific prudential run
PRUDENTIALRUNTRK	Records the prudential run accepted by Settlements staff for each prudential date

31.2 Diagram: Entities:Prudentials

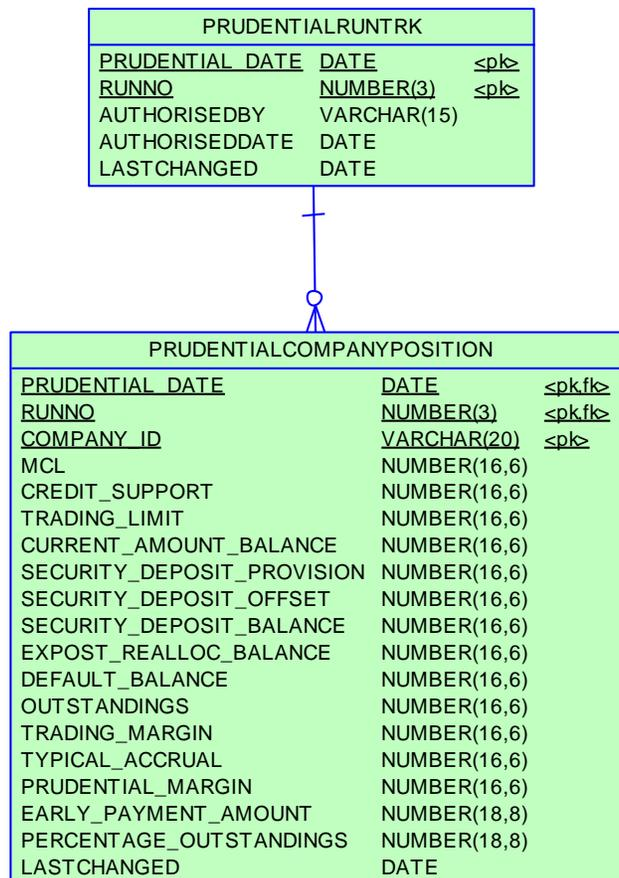

31.3 Table: PRUDENTIALCOMPANYPOSITION

31.3.1 PRUDENTIALCOMPANYPOSITION

Name	PRUDENTIALCOMPANYPOSITION
Comment	The prudential position of each company as at the datetime of a specific prudential run

31.3.2 Notes

Name	Comment	Value
Visibility	Data in this table is:	Private

31.3.3 Primary Key Columns

Name
 COMPANY_ID
 PRUDENTIAL_DATE
 RUNNO

31.3.4 Index Columns

Name
 LASTCHANGED

31.3.5 Content

Name	Data Type	Mandatory	Comment
PRUDENTIAL_DATE	DATE	X	The prudential date

RUNNO	NUMBER(3)	X	The run number for the prudential date
COMPANY_ID	VARCHAR(20)	X	The company identifier
MCL	NUMBER(16,6)		The Maximum Credit Limit of the company at the time of the prudential run
CREDIT_SUPPORT	NUMBER(16,6)		The Credit Support of the company at the time of the prudential run
TRADING_LIMIT	NUMBER(16,6)		The Trading Limit of the company at the time of the prudential run
CURRENT_AMOUNT_BALANCE	NUMBER(16,6)		The balance of the company for all unpaid billing weeks at the time of the prudential run
SECURITY_DEPOSIT_PROVISION	NUMBER(16,6)		The sum of all active security deposit provision amounts at the time of the prudential run
SECURITY_DEPOSIT_OFFSET	NUMBER(16,6)		The sum of all active security deposit application amounts at the time of the prudential run
SECURITY_DEPOSIT_BALANCE	NUMBER(16,6)		The balance of all active security deposits at the time of the prudential run
EXPOST_REALLOC_BALANCE	NUMBER(16,6)		The balance of all ex-post reallocations for the company that were calculated outside of billing runs at the time of the prudential run
DEFAULT_BALANCE	NUMBER(16,6)		The balance of all defaults for the company at the time of the prudential run
OUTSTANDINGS	NUMBER(16,6)		The total outstandings for the

			company at the time of the prudential run
TRADING_MARGIN	NUMBER(16,6)		The trading margin for the company at the time of the prudential run
TYPICAL_ACCRUAL	NUMBER(16,6)		The typical accrual for the company at the time of the prudential run
PRUDENTIAL_MARGIN	NUMBER(16,6)		The prudential margin is the current value determined by AEMO for the registered participant. It represents the buffer below the value of credit support which is used to set the trading limit
EARLY_PAYMENT_AMOUNT	NUMBER(18,8)		The early payment amount deducted from Outstandings in the prudential run
PERCENTAGE_OUTSTANDINGS	NUMBER(18,8)		The percentage of outstandings calculated against the trading margin and prudential margin
LASTCHANGED	DATE		The datetime that the record was last changed

31.4 Table: PRUDENTIALRUNTRK

31.4.1 PRUDENTIALRUNTRK

Name	PRUDENTIALRUNTRK
Comment	Records the prudential run accepted by Settlements staff for each prudential date

31.4.2 Notes

Name	Comment	Value
Visibility	Data in this table is:	Public

31.4.3 Primary Key Columns

Name

PRUDENTIAL_DATE

RUNNO

31.4.4 Index Columns

Name

LASTCHANGED

31.4.5 Content

Name	Data Type	Mandatory	Comment
PRUDENTIAL_DATE	DATE	X	The prudential date
RUNNO	NUMBER(3)	X	The run number for the prudential date

AUTHORISEDBY	VARCHAR(15)		The user that authorised the prudential run
AUTHORISEDDATE	DATE		The datetime that the prudential run was authorised
LASTCHANGED	DATE		The datetime that the record was last changed

32 Package: MCC_DISPATCH

<i>Name</i>	MCC_DISPATCH
<i>Comment</i>	Results from the Marginal Constraint Cost (MCC) re-run of the dispatch process. The MCC forms part of the part of the AER"s "Electricity transmission network service providers Service target performance incentive Scheme"

32.1 List of tables

Name	Comment
MCC_CASESOLUTION	Top level table for each MCC dispatch rerun process. Note there will be one record for each dispatch interval
MCC_CONSTRAINTSOLUTION	Constraint solution data from the MCC dispatch rerun process. Note only constraints with a non-zero marginal value are published.

32.2 Diagram: Entities: MCC_Dispatch

MCC_CASESOLUTION
<u>RUN_DATETIME</u> DATE <pk>

MCC_CONSTRAINTSOLUTION
<u>RUN_DATETIME</u> DATE <pk>
<u>CONSTRAINTID</u> VARCHAR2(20) <pk>
RHS NUMBER(15,5)
MARGINALVALUE NUMBER(15,5)

32.3 Table: MCC_CASESOLUTION

32.3.1 MCC_CASESOLUTION

Name	MCC_CASESOLUTION
Comment	Top level table for each MCC dispatch rerun process. Note there will be one record for each dispatch interval

32.3.2 Notes

Name	Comment	Value
Visibility	Data in this table is:	Private; Public Next-Day

32.3.3 Primary Key Columns

Name
RUN_DATETIME

32.3.4 Content

Name	Data Type	Mandatory	Comment
RUN_DATETIME	DATE	X	5-minute Dispatch Run identifier

32.4 Table: MCC_CONSTRAINTSOLUTION

32.4.1 MCC_CONSTRAINTSOLUTION

Name MCC_CONSTRAINTSOLUTION

Comment Constraint solution data from the MCC dispatch rerun process. Note only constraints with a non-zero marginal value are published.

32.4.2 Notes

Name	Comment	Value
Visibility	Data in this table is:	Private; Public Next-Day

32.4.3 Primary Key Columns

Name

CONSTRAINTID

RUN_DATETIME

32.4.4 Content

Name	Data Type	Mandatory	Comment
RUN_DATETIME	DATE	X	5-minute Dispatch Run identifier
CONSTRAINTID	VARCHAR2(20)	X	Generic Constraint identifier (synonymous with GenConID)
RHS	NUMBER(15,5)		Generic Constraint RHS Value for this MCC run
MARGINALVALUE	NUMBER(15,5)		Generic Constraint Marginal Value for this MCC run

33 Package: NETWORK

<i>Name</i>	NETWORK
<i>Comment</i>	Configuration data for the physical network

33.1 List of tables

Name	Comment
NETWORK_EQUIPMENTDETAIL	<p>NETWORK_EQUIPMENTDETAIL Provides details on equipment that may have outages or ratings. A single piece of equipment may have multiple records if its details change.</p> <p>A line will typically have at least two valid records at a time, once for each end of the line.</p>
NETWORK_OUTAGECONSTRAINTSET	<p>NETWORK_OUTAGECONSTRAINTSET lists the Constraint Set or Sets that are expected to be invoked for the outage once it is confirmed to proceed.</p>
NETWORK_OUTAGEDetail	<p>Lists asset owners planned outages for transmission equipment. This also includes details for transmission equipment that will not have an outage, but associated secondary equipment has an outage and a related constraint set may be invoked. This scenario is indicated by the ISSECONDARY field in the table</p>
NETWORK_OUTAGESTATUSCODE	<p>NETWORK_OUTAGESTATUSCODE describes the different outage status codes</p>
NETWORK_RATING	<p>NETWORK_RATING defines a list of the equipment ratings that may be used as inputs to market constraints.</p> <p>If the rating is flagged as dynamic then in real-time the rating will be dynamically determined and the static value will be used as a fallback value should the dynamic value fail.</p>

	<p>Note:</p> <p>In some rare cases equipment has ratings provided from more than one TNSP. This is identified by a different SPD Id. The value used in the NEM is normally the more restrictive of the two values.</p>
<p>NETWORK_REALTIMERATING</p>	<p>The NETWORK_REALTIMERATING table shows the equipment rating values in MVA used as inputs to constraints in the dispatch solution. This includes values for both static and dynamic ratings. The NETWORK_RATING table can be used to determine the physical equipment the rating is for based on the SPD_ID value.</p>
<p>NETWORK_STATICRATING</p>	<p>NETWORK_STATICRATING lists the static rating values that will apply for a Rating Application ID.</p> <p>This data does not provide information for when the rating actually applies in the NEM. This is dependent on the Rating Application definition.</p> <p>For information on the Rating Applications please refer to the information published on the AEMO website under the topic "Transmission Equipment Ratings". The Rating Applications are referred to as Alternate Value Application Ratings.</p> <p>Ratings that normally use dynamic values will also have static rating values defined. These are used as a fallback if the dynamic rating fails.</p>
<p>NETWORK_SUBSTATIONDETAIL</p>	<p>NETWORK_SUBSTATIONDETAIL sets out the attributes of sub-stations across time</p>

33.2 Diagram: Entities: NETWORK

NETWORK_SUBSTATIONDETAIL
<u>SUBSTATIONID</u>
VALIDFROM

NETWORK_EQUIPMENTDETAIL
<u>SUBSTATIONID</u>
<u>EQUIPMENTTYPE</u>
<u>EQUIPMENTID</u>
VALIDFROM

NETWORK_OUTAGEDDETAIL
<u>OUTAGEID</u>
<u>SUBSTATIONID</u>
<u>EQUIPMENTTYPE</u>
<u>EQUIPMENTID</u>
<u>STARTTIME</u>

NETWORK_OUTAGESTATUSCODE
<u>OUTAGESTATUSCODE</u>

NETWORK_OUTAGECONSTRAINTSET
<u>OUTAGEID</u>
<u>GENCONSETID</u>

NETWORK_RATING
<u>SPD_ID</u>
VALIDFROM

NETWORK_STATICRATING
<u>SUBSTATIONID</u>
<u>EQUIPMENTTYPE</u>
<u>EQUIPMENTID</u>
<u>RATINGLEVEL</u>
<u>APPLICATIONID</u>
VALIDFROM

NETWORK_REALTIMERATING
<u>SETTLEMENTDATE</u>
<u>SPD_ID</u>

33.3 Table: NETWORK_EQUIPMENTDETAIL

33.3.1 NETWORK_EQUIPMENTDETAIL

Name NETWORK_EQUIPMENTDETAIL

Comment NETWORK_EQUIPMENTDETAIL Provides details on equipment that may have outages or ratings. A single piece of equipment may have multiple records if its details change.

A line will typically have at least two valid records at a time, once for each end of the line.

33.3.2 Notes

Name	Comment	Value
Visibility	Data in this table is:	Public

33.3.3 Primary Key Columns

Name

EQUIPMENTID

EQUIPMENTTYPE

SUBSTATIONID

VALIDFROM

33.3.4 Index Columns

Name

LASTCHANGED

33.3.5 Content

Name	Data Type	Mandatory	Comment
SUBSTATIONID	VARCHAR(30)	X	ID uniquely identifying the substation this equipment is located at
EQUIPMENTTYPE	VARCHAR(10)	X	The type of equipment. Valid values are: LINE = Line TRANS = Transformer CB = Circuit breaker ISOL = Isolator CAP = Capacitor REAC = Reactor UNIT = Unit
EQUIPMENTID	VARCHAR(30)	X	A unique identifier for this type of equipment at this substation
VALIDFROM	DATE	X	The date that this record is applies from (inclusive)
VALIDTO	DATE		The date that this record applies until (exclusive)
VOLTAGE	VARCHAR(20)		The voltage in KV for this equipment. Transformers may have multiple voltages defined. E.g. 132_110_33
DESCRIPTION	VARCHAR(100)		A short description for this

)		equipment.
LASTCHANGED	DATE		The time that this record was last changed.

33.4 Table: NETWORK_OUTAGECONSTRAINTSET

33.4.1 NETWORK_OUTAGECONSTRAINTSET

Name	NETWORK_OUTAGECONSTRAINTSET
Comment	NETWORK_OUTAGECONSTRAINTSET lists the Constraint Set or Sets that are expected to be invoked for the outage once it is confirmed to proceed.

33.4.2 Notes

Name	Comment	Value
Visibility	Data in this table is:	Public

33.4.3 Primary Key Columns

Name

GENCONSETID

OUTAGEID

33.4.4 Content

Name	Data Type	Mandatory	Comment
OUTAGEID	NUMBER(15,0)	X	ID uniquely identifying the outage
GENCONSETID	VARCHAR(50)	X	ID for the constraint set
STARTINTERVAL	DATE		The dispatch interval that this constraint applies from
ENDINTERVAL	DATE		The dispatch interval the this constraint applies until

33.5 Table: NETWORK_OUTAGEDDETAIL

33.5.1 NETWORK_OUTAGEDDETAIL

Name	NETWORK_OUTAGEDDETAIL
Comment	Lists asset owners planned outages for transmission equipment. This also includes details for transmission equipment that will not have an outage, but associated secondary equipment has an outage and a related constraint set may be invoked. This scenario is indicated by the ISSECONDARY field in the table

33.5.2 Notes

Name	Comment	Value
Visibility	Data in this table is:	Public

33.5.3 Primary Key Columns

- Name
- EQUIPMENTID
- EQUIPMENTTYPE
- OUTAGEID
- STARTTIME
- SUBSTATIONID

33.5.4 Index Columns

- Name
- LASTCHANGED

33.5.5 Content

Name	Data Type	Mandatory	Comment
OUTAGEID	NUMBER(15,0)	X	ID uniquely identifying the outage
SUBSTATIONID	VARCHAR(30)	X	The substation this equipment is located at
EQUIPMENTTYPE	VARCHAR(10)	X	The type of equipment. Valid values are: LINE = Line TRANS = Transformer CB = Circuit breaker ISOL = Isolator CAP = Capacitor REAC = Reactor UNIT = Unit
EQUIPMENTID	VARCHAR(30)	X	A unique identifier for this equipment at this substation, and based on its type
STARTTIME	DATE	X	The planned starting date and time of the outage
ENDTIME	DATE		The planned ending date and time of the outage
SUBMITTEDDATE	DATE		The date and time this outage was first submitted
OUTAGESTATUSCODE	VARCHAR(10)		A code representing the status of the outage. The OUTAGESTATUSCODE table will store a detailed description of

			each code.
RESUBMITREASON	VARCHAR(50)		<p>Changes to an outage key details may require the outage to be resubmitted.</p> <p>A new outage id will then be allocated and the outage will be reassessed.</p> <p>This field will detail the reason for the change.</p>
RESUBMITOUTAGEID	NUMBER(15,0)		The new outage id created from a resubmit.
RECALLTIMEDAY	NUMBER(10,0)		The recall time in minutes during the day
RECALLTIMENIGHT	NUMBER(10,0)		The recall time in minutes during the night
LASTCHANGED	DATE		The time that this record was last changed
REASON	VARCHAR2(100)		The reason provided by the asset owner for this outage
ISSECONDARY	NUMBER(1,0)		1 = The outage is for a secondary piece of equipment that has an associated constraint set. The transmission equipment is still in service. 0 = The outage is for the transmission equipment
ACTUAL_STARTTIME	DATE		The actual starting date/time of the outage
ACTUAL_ENDTIME	DATE		The actual ending date/time of the outage

COMPANYREFCODE	VARCHAR2(20)		The asset owners reference code for this outage
----------------	------------------	--	--

33.6 Table: NETWORK_OUTAGESTATUSCODE

33.6.1 NETWORK_OUTAGESTATUSCODE

Name NETWORK_OUTAGESTATUSCODE
Comment NETWORK_OUTAGESTATUSCODE describes the different outage status codes

33.6.2 Notes

Name Comment Value
Visibility Data in this table is: Public

33.6.3 Primary Key Columns

Name
OUTAGESTATUSCODE

33.6.4 Content

Name	Data Type	Mandatory	Comment
OUTAGESTATUSCODE	VARCHAR(10)	X	A code representing the status of an outage
DESCRIPTION	VARCHAR(100)		A description of the status code
LASTCHANGED	DATE		The time that this record was last changed

33.7 Table: NETWORK_RATING

33.7.1 NETWORK_RATING

Name NETWORK_RATING

Comment NETWORK_RATING defines a list of the equipment ratings that may be used as inputs to market constraints.

If the rating is flagged as dynamic then in real-time the rating will be dynamically determined and the static value will be used as a fallback value should the dynamic value fail.

Note:

In some rare cases equipment has ratings provided from more than one TNSP. This is identified by a different SPD Id. The value used in the NEM is normally the more restrictive of the two values.

33.7.2 Notes

Name	Comment	Value
Visibility	Data in this table is:	Public

33.7.3 Primary Key Columns

Name

SPD_ID

VALIDFROM

33.7.4 Index Columns

Name

LASTCHANGED

33.7.5 Content

Name	Data Type	Mandatory	Comment
SPD_ID	VARCHAR(21)	X	ID defining this data source for use in constraints
VALIDFROM	DATE	X	The date that this record is applies from (inclusive)
VALIDTO	DATE		The date that this record applies until (exclusive)
REGIONID	VARCHAR(10)		The region that this rating is for
SUBSTATIONID	VARCHAR(30)		The substation the equipment is located at
EQUIPMENTTYPE	VARCHAR(10)		The type of equipment. Valid values are: LINE = Line TRANS = Transformer CB = Circuit breaker ISOL = Isolator CAP = Capacitor REAC = Reactor UNIT = Unit
EQUIPMENTID	VARCHAR(30)		A unique identifier for this equipment at this substation, and based on its type
RATINGLEVEL	VARCHAR(10)		The rating level of the value used, one of: NORM = Continuous rating value. Applied under pre-contingent

			<p>conditions.</p> <p>EMER = Continuous rating value. Applied under pre-contingent conditions</p> <p>LDSH = Load Shedding</p>
ISDYNAMIC	NUMBER(1,0)		<p>One of:</p> <p>1 = Normally uses dynamic ratings</p> <p>0 = No dynamic ratings, static ratings are used</p>
LASTCHANGED	DATE		<p>The time that this record was last changed</p>

33.8 Table: NETWORK_REALTIMERATING

33.8.1 NETWORK_REALTIMERATING

Name	NETWORK_REALTIMERATING
Comment	The NETWORK_REALTIMERATING table shows the equipment rating values in MVA used as inputs to constraints in the dispatch solution. This includes values for both static and dynamic ratings. The NETWORK_RATING table can be used to determine the physical equipment the rating is for based on the SPD_ID value.

33.8.2 Notes

Name	Comment	Value
Visibility	Data in this table is:	Public

33.8.3 Primary Key Columns

Name
SETTLEMENTDATE
SPD_ID

33.8.4 Content

Name	Data Type	Mandatory	Comment
SETTLEMENTDATE	DATE	X	The dispatch interval the rating applies to
SPD_ID	VARCHAR(21)	X	ID defining this data source for use in constraints
RATINGVALUE	NUMBER(16,6)	X	The defined equipment rating value in MVA

33.9 Table: NETWORK_STATICRATING

33.9.1 NETWORK_STATICRATING

Name	NETWORK_STATICRATING
Comment	<p>NETWORK_STATICRATING lists the static rating values that will apply for a Rating Application ID.</p> <p>This data does not provide information for when the rating actually applies in the NEM. This is dependent on the Rating Application definition.</p> <p>For information on the Rating Applications please refer to the information published on the AEMO website under the topic "Transmission Equipment Ratings". The Rating Applications are referred to as Alternate Value Application Ratings.</p> <p>Ratings that normally use dynamic values will also have static rating values defined. These are used as a fallback if the dynamic rating fails.</p>

33.9.2 Notes

Name	Comment	Value
Visibility	Data in this table is:	Public

33.9.3 Primary Key Columns

- Name
- APPLICATIONID
- EQUIPMENTID
- EQUIPMENTTYPE
- RATINGLEVEL

SUBSTATIONID

VALIDFROM

33.9.4 Index Columns

Name

LASTCHANGED

33.9.5 Content

Name	Data Type	Mandatory	Comment
SUBSTATIONID	VARCHAR(30)	X	The substation the equipment is located at
EQUIPMENTTYPE	VARCHAR(10)	X	The type of equipment. Valid values are: LINE = Line TRANS = Transformer CB = Circuit breaker ISOL = Isolator CAP = Capacitor REAC = Reactor UNIT = Unit
EQUIPMENTID	VARCHAR(30)	X	A unique identifier for this type of equipment at this substation
RATINGLEVEL	VARCHAR(10)	X	The rating level of the value used, one of: NORM = Continuous rating value. Applied under pre-contingent

			<p>conditions.</p> <p>EMER = Continuous rating value. Applied under pre-contingent conditions</p> <p>LDSH = Load Shedding</p>
APPLICATIONID	VARCHAR(20)	X	The applicationid which defines the application timeframes of this rating.
VALIDFROM	DATE	X	The date that this record is applies from (inclusive)
VALIDTO	DATE		The date that this record applies until (exclusive)
RATINGVALUE	NUMBER(16,6)		<p>The rating value in MVA that applies. This may be positive or negative depending on which side of the nominal MW flow direction the rating value applies.</p> <p>Flow into a transmission device is positive, flow out of the device is negative.</p>
LASTCHANGED	DATE		The time that this record was last changed.

33.10 Table: NETWORK_SUBSTATIONDETAIL

33.10.1 NETWORK_SUBSTATIONDETAIL

Name	NETWORK_SUBSTATIONDETAIL
Comment	NETWORK_SUBSTATIONDETAIL sets out the attributes of substations across time

33.10.2 Notes

Name	Comment	Value
Visibility	Data in this table is:	Public

33.10.3 Primary Key Columns

Name

SUBSTATIONID

VALIDFROM

33.10.4 Index Columns

Name

LASTCHANGED

33.10.5 Content

Name	Data Type	Mandatory	Comment
SUBSTATIONID	VARCHAR(30)	X	ID uniquely identifying this substation
VALIDFROM	DATE	X	The record is valid from this date

			(inclusive)
VALIDTO	DATE		The record is valid up until this date (exclusive)
DESCRIPTION	VARCHAR(100)		Description of the substation
REGIONID	VARCHAR(10)		The NEM region the substation is in
OWNERID	VARCHAR(30)		The TNSP who is responsible for this substation
LASTCHANGED	DATE		The time that this record was last changed.

34 Package: VOLTAGE_INSTRUCTIONS

Name VOLTAGE_INSTRUCTIONS
Comment Instructions for MVAr Dispatch

34.1 List of tables

Name	Comment
VOLTAGE_INSTRUCTION	Child record for Voltage Instructions (MVAr Dispatch)
VOLTAGE_INSTRUCTION_TRK	Parent record for Voltage Instructions (MVAr Dispatch). 'SIGNAL' records will have no children; 'INSTRUCTION' records will have children

34.2 Diagram: Entities: Voltage Instructions

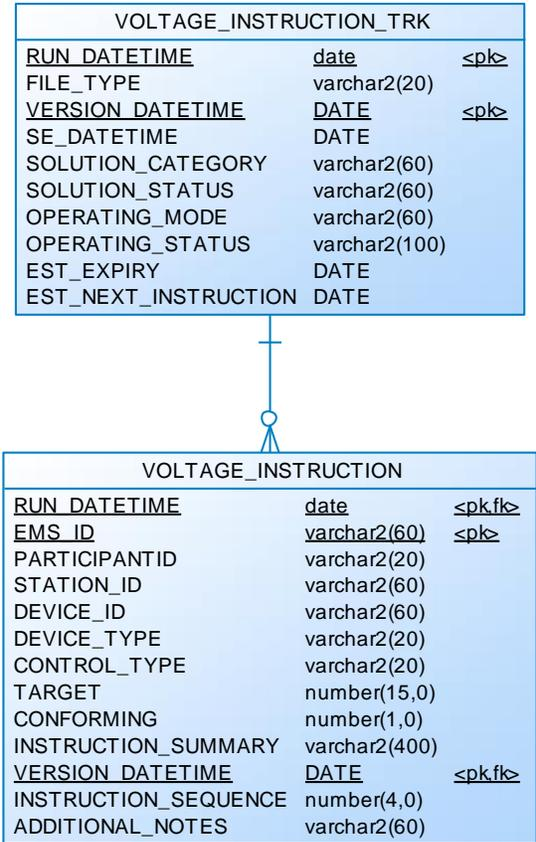

34.3 Table: VOLTAGE_INSTRUCTION

34.3.1 VOLTAGE_INSTRUCTION

Name VOLTAGE_INSTRUCTION
 Comment Child record for Voltage Instructions (MVAr Dispatch)

34.3.2 Notes

Name Comment Value
 Visibility Data in this table is: Public

34.3.3 Primary Key Columns

Name
 EMS_ID
 RUN_DATETIME
 VERSION_DATETIME

34.3.4 Index Columns

Name
 RUN_DATETIME
 VERSION_DATETIME
 EMS_ID

34.3.5 Content

Name	Data Type	Mandatory	Comment
------	-----------	-----------	---------

RUN_DATETIME	date	X	MVAr Interval – a timestamp of when instructions issued
EMS_ID	varchar2(60)	X	The unique identifier for reference within AEMO –matches equipment names between NOS and EMS
PARTICIPANTID	varchar2(20)		The NEM id of the participant who owns the equipment
STATION_ID	varchar2(60)		The id of the station where the control equipment resides
DEVICE_ID	varchar2(60)		The company/participant preferred name of an equipment
DEVICE_TYPE	varchar2(20)		One of REACTOR, CAPACITOR, GEN, SVC, TRANS or GRPGEN but may be extended to other types
CONTROL_TYPE	varchar2(20)		One of VOLTAGE, TAP, MVAR, SWITCH or COMMIT but may be extended to other types
TARGET	number(15,0)		Instruction for the device, for this interval – null denotes no instruction
CONFORMING	number(1,0)		[0,1] Denotes if the Device is currently conforming
INSTRUCTION_SUMMARY	varchar2(400)		Verbose summary of instruction
VERSION_DATETIME	DATE	X	Datetime the file was published by VDS - Versions differ from Run_DateTime only for Supplemental runs
INSTRUCTION_SEQUENCE	number(4,0)		Order for execution of Instruction
ADDITIONAL_NOTES	varchar2(60)		Additional information pertaining to a particular instruction, e.g.

			Previously issued instruction revoked
--	--	--	--

34.4 Table: VOLTAGE_INSTRUCTION_TRK

34.4.1 VOLTAGE_INSTRUCTION_TRK

Name	VOLTAGE_INSTRUCTION_TRK
Comment	Parent record for Voltage Instructions (MVAR Dispatch). 'SIGNAL' records will have no children; 'INSTRUCTION' records will have children

34.4.2 Notes

Name	Comment	Value
Visibility	Data in this table is:	Public

34.4.3 Primary Key Columns

Name
RUN_DATETIME
VERSION_DATETIME

34.4.4 Index Columns

Name
RUN_DATETIME
VERSION_DATETIME

34.4.5 Content

Name	Data Type	Mandatory	Comment
RUN_DATETIME	date	X	MVAR Interval - a timestamp of

			when instructions issued
FILE_TYPE	varchar2(20)		Either 'SIGNAL' (childless) or 'INSTRUCTION'
VERSION_DATETIME	DATE	X	Datetime the file was published by VDS - Versions differ from Run_DateTime only for Supplemental runs
SE_DATETIME	DATE		State Estimator start time, when a snapshot is taken of SCADA values
SOLUTION_CATEGORY	varchar2(60)		VDS solver solution category. Valid values: SUCCESS, WARNING, FAILURE
SOLUTION_STATUS	varchar2(60)		VDS solver solution status. Valid values: NOACTCNV [Solved with no instructions], NOVIOACT, CONVERGE, UNMANAGE, UNMANCTG, CTGDIV, SENHDIV [Failed with too many violations], BCDIV
OPERATING_MODE	varchar2(60)		The current VDS operating mode. Valid values: AUTO, AUTO-VERIFIED, MANUAL
OPERATING_STATUS	varchar2(100)		Unstructured code and message from AEMO
EST_EXPIRY	DATE		Estimated expiry time of current Instruction set
EST_NEXT_INSTRUCTION	DATE		Estimated issue time of next Instruction set

35 List of tables

Name	Parent
ANCILLARY_RECOVERY_SPLIT	Package 'SETTLEMENT_CONFIG'
APCCOMP	Package 'HISTORICAL TABLES'
APCCOMPAMOUNT	Package 'HISTORICAL TABLES'
APCCOMPAMOUNTTRK	Package 'HISTORICAL TABLES'
APEVENT	Package 'FORCE_MAJEURE'
APEVENTREGION	Package 'FORCE_MAJEURE'
AUCTION	Package 'IRAUCTION'
AUCTION_CALENDAR	Package 'IRAUCTION'
AUCTION_IC_ALLOCATIONS	Package 'IRAUCTION'
AUCTION_REVENUE_ESTIMATE	Package 'IRAUCTION'
AUCTION_REVENUE_TRACK	Package 'IRAUCTION'
AUCTION_RP_ESTIMATE	Package 'IRAUCTION'
AUCTION_TRANCHE	Package 'IRAUCTION'
BIDDAYOFFER	Package 'BIDS'
BIDDAYOFFER_D	Package 'BIDS'
BIDDUIDDETAILS	Package 'PARTICIPANT_REGISTRATION'
BIDDUIDDETAILSTRK	Package 'PARTICIPANT_REGISTRATION'
BIDOFFERFILETRK	Package 'BIDS'
BIDPEROFFER	Package 'BIDS'

BIDPEROFFER_D	Package 'BIDS'
BIDTYPES	Package 'MARKET_CONFIG'
BIDYPESTRK	Package 'MARKET_CONFIG'
BILLADJUSTMENTS	Package 'HISTORICAL TABLES'
BILLING_APC_COMPENSATION	Package 'BILLING_RUN'
BILLING_APC_RECOVERY	Package 'BILLING_RUN'
BILLING_CO2E_PUBLICATION	Package 'BILLING_RUN'
BILLING_CO2E_PUBLICATION_TRK	Package 'BILLING_RUN'
BILLING_CSP_DEROGATION_AMOUNT	Package 'HISTORICAL TABLES'
BILLING_DAILY_ENERGY_SUMMARY	Package 'BILLING_RUN'
BILLING_DIRECTION_RECON_OTHER	Package 'BILLING_RUN'
BILLING_DIRECTION_RECONCILIATN	Package 'BILLING_RUN'
BILLING_EFTSHORTFALL_AMOUNT	Package 'BILLING_RUN'
BILLING_EFTSHORTFALL_DETAIL	Package 'BILLING_RUN'
BILLING_GST_DETAIL	Package 'BILLING_RUN'
BILLING_GST_SUMMARY	Package 'BILLING_RUN'
BILLING_MR_PAYMENT	Package 'BILLING_RUN'
BILLING_MR_RECOVERY	Package 'BILLING_RUN'
BILLING_MR_SHORTFALL	Package 'BILLING_RUN'
BILLING_MR_SUMMARY	Package 'BILLING_RUN'
BILLING_NMAS_TST_PAYMENTS	Package 'BILLING_RUN'
BILLING_NMAS_TST_RECOVERY	Package 'BILLING_RUN'
BILLING_NMAS_TST_RECVRY_RBF	Package 'BILLING_RUN'

BILLING_NMAS_TST_RECVRVY_TRK	Package 'BILLING_RUN'
BILLING_RES_TRADER_PAYMENT	Package 'BILLING_RUN'
BILLING_RES_TRADER_RECOVERY	Package 'BILLING_RUN'
BILLING_SECDEP_INTEREST_PAY	Package 'BILLING_RUN'
BILLING_SECDEP_INTEREST_RATE	Package 'BILLING_RUN'
BILLING_SECDEPOSIT_APPLICATION	Package 'BILLING_RUN'
BILLINGAPCCOMPENSATION	Package 'BILLING_RUN'
BILLINGAPCRECOVERY	Package 'BILLING_RUN'
BILLINGASPAYMENTS	Package 'BILLING_RUN'
BILLINGASRECOVERY	Package 'BILLING_RUN'
BILLINGCALENDAR	Package 'BILLING_CONFIG'
BILLINGCPDATA	Package 'BILLING_RUN'
BILLINGCPSUM	Package 'HISTORICAL TABLES'
BILLINGCUSTEXCESSGEN	Package 'HISTORICAL TABLES'
BILLINGDAYTRK	Package 'BILLING_RUN'
BILLINGEXCESSGEN	Package 'HISTORICAL TABLES'
BILLINGFEES	Package 'BILLING_RUN'
BILLINGFINANCIALADJUSTMENTS	Package 'BILLING_RUN'
BILLINGGENDATA	Package 'BILLING_RUN'
BILLINGINTERRESIDUES	Package 'BILLING_RUN'
BILLINGINTERVENTION	Package 'HISTORICAL TABLES'
BILLINGINTERVENTIONREGION	Package 'HISTORICAL TABLES'
BILLINGINTRARESIDUES	Package 'BILLING_RUN'

BILLINGIRAUCSURPLUS	Package 'BILLING_RUN'
BILLINGIRAUCSURPLUSSUM	Package 'BILLING_RUN'
BILLINGIRFM	Package 'BILLING_RUN'
BILLINGIRNSPSURPLUS	Package 'BILLING_RUN'
BILLINGIRNSPSURPLUSSUM	Package 'BILLING_RUN'
BILLINGIRPARTSURPLUS	Package 'BILLING_RUN'
BILLINGIRPARTSURPLUSSUM	Package 'BILLING_RUN'
BILLINGPRIORADJUSTMENTS	Package 'BILLING_RUN'
BILLINGREALLOC	Package 'BILLING_RUN'
BILLINGREALLOC_DETAIL	Package 'BILLING_RUN'
BILLINGREGIONEXPORTS	Package 'BILLING_RUN'
BILLINGREGIONFIGURES	Package 'BILLING_RUN'
BILLINGREGIONIMPORTS	Package 'BILLING_RUN'
BILLINGRESERVERECOVERY	Package 'HISTORICAL TABLES'
BILLINGRESERVEREGIONRECOVERY	Package 'HISTORICAL TABLES'
BILLINGRESERVETRADER	Package 'HISTORICAL TABLES'
BILLINGRESERVETRADERREGION	Package 'HISTORICAL TABLES'
BILLINGRUNTRK	Package 'BILLING_RUN'
BILLINGSMELTERREDUCTION	Package 'BILLING_RUN'
BILLINTERVENTIONRECOVERY	Package 'HISTORICAL TABLES'
BILLINTERVENTIONREGIONRECOVERY	Package 'HISTORICAL TABLES'
BILLSMELTERRATE	Package 'HISTORICAL TABLES'
BILLWHITEHOLE	Package 'BILLING_RUN'

CONNECTIONPOINT	Package 'HISTORICAL TABLES'
CONNECTIONPOINTDETAILS	Package 'HISTORICAL TABLES'
CONNECTIONPOINTOPERATINGSTA	Package 'HISTORICAL TABLES'
CONSTRAINTRELAXATION_OCD	Package 'DISPATCH'
CONTRACTAGC	Package 'ANCILLARY_SERVICES'
CONTRACTGOVERNOR	Package 'HISTORICAL TABLES'
CONTRACTLOADSHED	Package 'ANCILLARY_SERVICES'
CONTRACTREACTIVEPOWER	Package 'ANCILLARY_SERVICES'
CONTRACTRESERVEFLAG	Package 'HISTORICAL TABLES'
CONTRACTRESERVETHRESHOLD	Package 'HISTORICAL TABLES'
CONTRACTRESERVETRADER	Package 'HISTORICAL TABLES'
CONTRACTRESTARTSERVICES	Package 'ANCILLARY_SERVICES'
CONTRACTRESTARTUNITS	Package 'ANCILLARY_SERVICES'
CONTRACTUNITLOADING	Package 'HISTORICAL TABLES'
CONTRACTUNITUNLOADING	Package 'HISTORICAL TABLES'
DAYOFFER	Package 'HISTORICAL TABLES'
DAYOFFER_D	Package 'HISTORICAL TABLES'
DAYTRACK	Package 'SETTLEMENT_DATA'
DEFAULTDAYOFFER	Package 'HISTORICAL TABLES'
DEFAULTOFFERTRK	Package 'HISTORICAL TABLES'
DEFAULTPEROFFER	Package 'HISTORICAL TABLES'
DELTAMW	Package 'HISTORICAL TABLES'
DEMANDOPERATIONALACTUAL	Package 'DEMAND_FORECASTS'

DEMANDOPERATIONALFORECAST	Package 'DEMAND_FORECASTS'
DISPATCH_CONSTRAINT_FCAS_OCD	Package 'DISPATCH'
DISPATCH_FCAS_REQ	Package 'DISPATCH'
DISPATCH_INTERCONNECTION	Package 'DISPATCH'
DISPATCH_LOCAL_PRICE	Package 'DISPATCH'
DISPATCH_MNSPBIDTRK	Package 'DISPATCH'
DISPATCH_MR_SCHEDULE_TRK	Package 'DISPATCH'
DISPATCH_PRICE_REVISION	Package 'DISPATCH'
DISPATCH_UNIT_CONFORMANCE	Package 'DISPATCH'
DISPATCH_UNIT_SCADA	Package 'DISPATCH'
DISPATCHABLEUNIT	Package 'PARTICIPANT_REGISTRATION'
DISPATCHBIDTRK	Package 'HISTORICAL TABLES'
DISPATCHBLOCKEDCONSTRAINT	Package 'DISPATCH'
DISPATCHCASE_OCD	Package 'HISTORICAL TABLES'
DISPATCHCASESOLUTION	Package 'DISPATCH'
DISPATCHCASESOLUTION_BNC	Package 'HISTORICAL TABLES'
DISPATCHCONSTRAINT	Package 'DISPATCH'
DISPATCHINTERCONNECTORRES	Package 'DISPATCH'
DISPATCHLOAD	Package 'DISPATCH'
DISPATCHLOAD_BNC	Package 'HISTORICAL TABLES'
DISPATCHOFFERTRK	Package 'DISPATCH'
DISPATCHPRICE	Package 'DISPATCH'

DISPATCHREGIONSUM	Package 'DISPATCH'
DISPATCHTRK	Package 'HISTORICAL TABLES'
DUALLOC	Package 'PARTICIPANT_REGISTRATION'
DUDETAIL	Package 'PARTICIPANT_REGISTRATION'
DUDETAILSUMMARY	Package 'PARTICIPANT_REGISTRATION'
EMSMASTER	Package 'GENERIC_CONSTRAINT'
FORCEMAJEURE	Package 'HISTORICAL TABLES'
FORCEMAJEUREREGION	Package 'HISTORICAL TABLES'
GDINSTRUCT	Package 'GD_INSTRUCT'
GENCONDATA	Package 'GENERIC_CONSTRAINT'
GENCONSET	Package 'GENERIC_CONSTRAINT'
GENCONSETINVOKE	Package 'GENERIC_CONSTRAINT'
GENCONSETTRK	Package 'GENERIC_CONSTRAINT'
GENERICCONSTRAINTRHS	Package 'GENERIC_CONSTRAINT'
GENERICEQUATIONDESC	Package 'GENERIC_CONSTRAINT'
GENERICEQUATIONRHS	Package 'GENERIC_CONSTRAINT'
GENMETER	Package 'PARTICIPANT_REGISTRATION'
GENUNITMTRINPERIOD	Package 'HISTORICAL TABLES'
GENUNITS	Package 'PARTICIPANT_REGISTRATION'
GENUNITS_UNIT	Package

	'PARTICIPANT_REGISTRATION'
GST_BAS_CLASS	Package 'BILLING_CONFIG'
GST_RATE	Package 'BILLING_CONFIG'
GST_TRANSACTION_CLASS	Package 'BILLING_CONFIG'
GST_TRANSACTION_TYPE	Package 'BILLING_CONFIG'
INSTRUCTIONSUBTYPE	Package 'GD_INSTRUCT'
INSTRUCTIONTYPE	Package 'GD_INSTRUCT'
INTCONTRACT	Package 'HISTORICAL TABLES'
INTCONTRACTAMOUNT	Package 'HISTORICAL TABLES'
INTCONTRACTAMOUNTTRK	Package 'HISTORICAL TABLES'
INTERCONNECTOR	Package 'MARKET_CONFIG'
INTERCONNECTORALLOC	Package 'MARKET_CONFIG'
INTERCONNECTORCONSTRAINT	Package 'MARKET_CONFIG'
INTERCONNMWFLOW	Package 'HISTORICAL TABLES'
INTERMITTENT_CLUSTER_AVAIL	Package 'DEMAND_FORECASTS'
INTERMITTENT_CLUSTER_AVAIL_DAY	Package 'DEMAND_FORECASTS'
INTERMITTENT_DS_PRED	Package 'DEMAND_FORECASTS'
INTERMITTENT_DS_RUN	Package 'DEMAND_FORECASTS'
INTERMITTENT_FORECAST_TRK	Package 'DISPATCH'
INTERMITTENT_GEN_FCST	Package 'DEMAND_FORECASTS'
INTERMITTENT_GEN_FCST_DATA	Package 'DEMAND_FORECASTS'
INTERMITTENT_GEN_LIMIT	Package 'DEMAND_FORECASTS'
INTERMITTENT_GEN_LIMIT_DAY	Package 'DEMAND_FORECASTS'

INTERMITTENT_P5_PRED	Package 'DEMAND_FORECASTS'
INTERMITTENT_P5_RUN	Package 'DEMAND_FORECASTS'
INTRAREGIONALLOC	Package 'MARKET_CONFIG'
IRFMAMOUNT	Package 'FORCE_MAJEURE'
IRFMEVENTS	Package 'FORCE_MAJEURE'
LOSSFACTORMODEL	Package 'MARKET_CONFIG'
LOSSMODEL	Package 'MARKET_CONFIG'
MARKET_FEE_CAT_EXCL	Package 'SETTLEMENT_CONFIG'
MARKET_FEE_CAT_EXCL_TRK	Package 'SETTLEMENT_CONFIG'
MARKET_FEE_EXCLUSION	Package 'SETTLEMENT_CONFIG'
MARKET_FEE_EXCLUSIONTRK	Package 'SETTLEMENT_CONFIG'
MARKET_PRICE_THRESHOLDS	Package 'MARKET_CONFIG'
MARKET_SUSPEND_REGIME_SUM	Package 'FORCE_MAJEURE'
MARKET_SUSPEND_REGION_SUM	Package 'FORCE_MAJEURE'
MARKET_SUSPEND_SCHEDULE	Package 'FORCE_MAJEURE'
MARKET_SUSPEND_SCHEDULE_TRK	Package 'FORCE_MAJEURE'
MARKETFEE	Package 'SETTLEMENT_CONFIG'
MARKETFEEDATA	Package 'SETTLEMENT_CONFIG'
MARKETFEETRK	Package 'SETTLEMENT_CONFIG'
MARKETNOTICEDATA	Package 'MARKET_NOTICE'
MARKETNOTICETYPE	Package 'MARKET_NOTICE'
MARKETSUSPENSION	Package 'HISTORICAL TABLES'
MARKETSUSREGION	Package 'HISTORICAL TABLES'

MAS_CP_CHANGE	Package 'HISTORICAL TABLES'
MAS_CP_MASTER	Package 'HISTORICAL TABLES'
MCC_CASESOLUTION	Package 'MCC_DISPATCH'
MCC_CONSTRAINTSOLUTION	Package 'MCC_DISPATCH'
METERDATA	Package 'HISTORICAL TABLES'
METERDATA_AGGREGATE_READS	Package 'METER_DATA'
METERDATA_GEN_DUID	Package 'HISTORICAL TABLES'
METERDATA_INDIVIDUAL_READS	Package 'METER_DATA'
METERDATA_INTERCONNECTOR	Package 'METER_DATA'
METERDATA_TRK	Package 'METER_DATA'
METERDATATRK	Package 'HISTORICAL TABLES'
MMS_DATA_MODEL_AUDIT	Package 'CONFIGURATION'
MNSP_DAYOFFER	Package 'BIDS'
MNSP_FILETRK	Package 'BIDS'
MNSP_INTERCONNECTOR	Package 'PARTICIPANT_REGISTRATION'
MNSP_OFFERTRK	Package 'BIDS'
MNSP_PARTICIPANT	Package 'PARTICIPANT_REGISTRATION'
MNSP_PEROFFER	Package 'BIDS'
MR_DAYOFFER_STACK	Package 'MREVENT'
MR_EVENT	Package 'MREVENT'
MR_EVENT_SCHEDULE	Package 'MREVENT'
MR_PEROFFER_STACK	Package 'MREVENT'

MTPASA_CASE_SET	Package 'HISTORICAL TABLES'
MTPASA_CASERESULT	Package 'MTPASA'
MTPASA_CASESOLUTION	Package 'HISTORICAL TABLES'
MTPASA_CONSTRAINTRESULT	Package 'MTPASA'
MTPASA_CONSTRAINTSOLUTION	Package 'HISTORICAL TABLES'
MTPASA_CONSTRAINTSUMMARY	Package 'MTPASA'
MTPASA_INTERCONNECTORRESULT	Package 'MTPASA'
MTPASA_INTERCONNECTORSOLUTION	Package 'HISTORICAL TABLES'
MTPASA_INTERMITTENT_AVAIL	Package 'DEMAND_FORECASTS'
MTPASA_INTERMITTENT_LIMIT	Package 'DEMAND_FORECASTS'
MTPASA_LOLRESULT	Package 'MTPASA'
MTPASA_OFFERDATA	Package 'BIDS'
MTPASA_OFFERFILETRK	Package 'BIDS'
MTPASA_REGIONAVAIL_TRK	Package 'MTPASA'
MTPASA_REGIONAVAILABILITY	Package 'MTPASA'
MTPASA_REGIONITERATION	Package 'MTPASA'
MTPASA_REGIONRESULT	Package 'MTPASA'
MTPASA_REGIONSOLUTION	Package 'HISTORICAL TABLES'
MTPASA_REGIONSUMMARY	Package 'MTPASA'
MTPASA_RESERVELIMIT	Package 'RESERVE_DATA'
MTPASA_RESERVELIMIT_REGION	Package 'RESERVE_DATA'
MTPASA_RESERVELIMIT_SET	Package 'RESERVE_DATA'
MTPASA_RESERVELIMITSOLUTION	Package 'HISTORICAL TABLES'

MTPASACONSTRAINTSOLUTION_D	Package 'HISTORICAL TABLES'
MTPASAINTERCONNECTORSOLUTION_D	Package 'HISTORICAL TABLES'
MTPASAREGIONSOLUTION_D	Package 'HISTORICAL TABLES'
NEGATIVE_RESIDUE	Package 'DISPATCH'
NETWORK_EQUIPMENTDETAIL	Package 'NETWORK'
NETWORK_OUTAGECONSTRAINTSET	Package 'NETWORK'
NETWORK_OUTAGEDetail	Package 'NETWORK'
NETWORK_OUTAGESTATUSCODE	Package 'NETWORK'
NETWORK_RATING	Package 'NETWORK'
NETWORK_REALTIMERATING	Package 'NETWORK'
NETWORK_STATICRATING	Package 'NETWORK'
NETWORK_SUBSTATIONDETAIL	Package 'NETWORK'
OARTRACK	Package 'HISTORICAL TABLES'
OFFERAGCDATA	Package 'ASOFFER'
OFFERASTRK	Package 'ASOFFER'
OFFERFILETRK	Package 'HISTORICAL TABLES'
OFFERGOVDATA	Package 'HISTORICAL TABLES'
OFFERLSHEDDATA	Package 'ASOFFER'
OFFERRESTARTDATA	Package 'ASOFFER'
OFFERRPOWERDATA	Package 'ASOFFER'
OFFERULOADINGDATA	Package 'HISTORICAL TABLES'
OFFERUNLOADINGDATA	Package 'HISTORICAL TABLES'
OVERRIDEERP	Package 'FORCE_MAJEURE'

P5MIN_BLOCKEDCONSTRAINT	Package 'P5MIN'
P5MIN_CASESOLUTION	Package 'P5MIN'
P5MIN_CONSTRAINTSOLUTION	Package 'P5MIN'
P5MIN_INTERCONNECTORSOLN	Package 'P5MIN'
P5MIN_LOCAL_PRICE	Package 'P5MIN'
P5MIN_REGIONSOLUTION	Package 'P5MIN'
P5MIN_UNITSOLUTION	Package 'P5MIN'
PARTICIPANT	Package 'PARTICIPANT_REGISTRATION'
PARTICIPANT_BANDFEE_ALLOC	Package 'SETTLEMENT_CONFIG'
PARTICIPANTACCOUNT	Package 'PARTICIPANT_REGISTRATION'
PARTICIPANTCATEGORY	Package 'PARTICIPANT_REGISTRATION'
PARTICIPANTCATEGORYALLOC	Package 'PARTICIPANT_REGISTRATION'
PARTICIPANTCLASS	Package 'PARTICIPANT_REGISTRATION'
PARTICIPANTCREDITDETAIL	Package 'PARTICIPANT_REGISTRATION'
PARTICIPANTNOTICETRK	Package 'MARKET_NOTICE'
PASACASESOLUTION	Package 'HISTORICAL TABLES'
PASACONSTRAINTSOLUTION	Package 'HISTORICAL TABLES'
PASAINTERCONNECTORSOLUTION	Package 'HISTORICAL TABLES'
PASAREGIONSOLUTION	Package 'HISTORICAL TABLES'

PDPASA_CASESOLUTION	Package 'PDPASA'
PDPASA_REGIONSOLUTION	Package 'PDPASA'
PERDEMAND	Package 'DEMAND_FORECASTS'
PEROFFER	Package 'HISTORICAL TABLES'
PEROFFER_D	Package 'HISTORICAL TABLES'
PREDISPATCH_FCAS_REQ	Package 'PRE_DISPATCH'
PREDISPATCH_LOCAL_PRICE	Package 'PRE_DISPATCH'
PREDISPATCH_MNSPBIDTRK	Package 'PRE_DISPATCH'
PREDISPATCHBIDTRK	Package 'HISTORICAL TABLES'
PREDISPATCHBLOCKEDCONSTRAINT	Package 'PRE_DISPATCH'
PREDISPATCHCASESOLUTION	Package 'PRE_DISPATCH'
PREDISPATCHCONSTRAINT	Package 'PRE_DISPATCH'
PREDISPATCHINTERCONNECTORRES	Package 'PRE_DISPATCH'
PREDISPATCHINTERSENSITIVITIES	Package 'PRE_DISPATCH'
PREDISPATCHLOAD	Package 'PRE_DISPATCH'
PREDISPATCHOFFERTRK	Package 'PRE_DISPATCH'
PREDISPATCHPRICE	Package 'PRE_DISPATCH'
PREDISPATCHPRICESENSITIVITIES	Package 'PRE_DISPATCH'
PREDISPATCHREGIONSUM	Package 'PRE_DISPATCH'
PREDISPATCHSCENARIODEMAND	Package 'PRE_DISPATCH'
PREDISPATCHSCENARIODEMANDTRK	Package 'PRE_DISPATCH'
PRUDENTIALCOMPANYPOSITION	Package 'PRUDENTIALS'
PRUDENTIALRUNTRK	Package 'PRUDENTIALS'

REALLOCATION	Package 'SETTLEMENT_CONFIG'
REALLOCATIONDETAILS	Package 'HISTORICAL TABLES'
REALLOCATIONINTERVAL	Package 'SETTLEMENT_CONFIG'
REALLOCATIONINTERVALS	Package 'HISTORICAL TABLES'
REALLOCATIONS	Package 'HISTORICAL TABLES'
REGION	Package 'MARKET_CONFIG'
REGIONAPC	Package 'FORCE_MAJEURE'
REGIONAPCINTERVALS	Package 'FORCE_MAJEURE'
REGIONFCASRELAXATION_OCD	Package 'HISTORICAL TABLES'
REGIONSTANDINGDATA	Package 'MARKET_CONFIG'
RESEMANDTRK	Package 'DEMAND_FORECASTS'
RESERVE	Package 'RESERVE_DATA'
RESIDUE_BID_TRK	Package 'IRAUCTION'
RESIDUE_CON_DATA	Package 'IRAUCTION'
RESIDUE_CON_ESTIMATES_TRK	Package 'IRAUCTION'
RESIDUE_CON_FUNDS	Package 'IRAUCTION'
RESIDUE_CONTRACTS	Package 'IRAUCTION'
RESIDUE_FUNDS_BID	Package 'IRAUCTION'
RESIDUE_PRICE_BID	Package 'IRAUCTION'
RESIDUE_PRICE_FUNDS_BID	Package 'IRAUCTION'
RESIDUE_PUBLIC_DATA	Package 'IRAUCTION'
RESIDUE_TRK	Package 'IRAUCTION'
RESIDUECONTRACTPAYMENTS	Package 'IRAUCTION'

RESIDUEFILETRK	Package 'IRAUCTION'
ROOFTOP_PV_ACTUAL	Package 'DEMAND_FORECASTS'
ROOFTOP_PV_FORECAST	Package 'DEMAND_FORECASTS'
SECDEPOSIT_INTEREST_RATE	Package 'BILLING_CONFIG'
SECDEPOSIT_PROVISION	Package 'BILLING_CONFIG'
SET_APC_COMPENSATION	Package 'SETTLEMENT_DATA'
SET_APC_RECOVERY	Package 'SETTLEMENT_DATA'
SET_ANCILLARY_SUMMARY	Package 'SETTLEMENT_DATA'
SET_CSP_DEROGATION_AMOUNT	Package 'HISTORICAL TABLES'
SET_CSP_SUPPORTDATA_CONSTRAINT	Package 'HISTORICAL TABLES'
SET_CSP_SUPPORTDATA_ENERGYDIFF	Package 'HISTORICAL TABLES'
SET_CSP_SUPPORTDATA_SUBPRICE	Package 'HISTORICAL TABLES'
SET_FCAS_PAYMENT	Package 'SETTLEMENT_DATA'
SET_FCAS_RECOVERY	Package 'SETTLEMENT_DATA'
SET_FCAS_REGULATION_TRK	Package 'SETTLEMENT_DATA'
SET_MR_PAYMENT	Package 'SETTLEMENT_DATA'
SET_MR_RECOVERY	Package 'SETTLEMENT_DATA'
SET_NMAS_RECOVERY	Package 'SETTLEMENT_DATA'
SET_NMAS_RECOVERY_RBF	Package 'SETTLEMENT_DATA'
SET_RUN_PARAMETER	Package 'SETTLEMENT_DATA'
SETAGCPAYMENT	Package 'SETTLEMENT_DATA'
SETAGCRECOVERY	Package 'SETTLEMENT_DATA'
SETAPCCOMPENSATION	Package 'HISTORICAL TABLES'

SETAPCRECOVERY	Package 'HISTORICAL TABLES'
SETCFG_PARTICIPANT_MPF	Package 'SETTLEMENT_CONFIG'
SETCFG_PARTICIPANT_MPFTRK	Package 'SETTLEMENT_CONFIG'
SETCPDATA	Package 'SETTLEMENT_DATA'
SETCPDATAREGION	Package 'SETTLEMENT_DATA'
SETFCASCOMP	Package 'SETTLEMENT_DATA'
SETFCASRECOVERY	Package 'HISTORICAL TABLES'
SETFCASREGIONRECOVERY	Package 'SETTLEMENT_DATA'
SETGENDATA	Package 'SETTLEMENT_DATA'
SETGENDATAREGION	Package 'SETTLEMENT_DATA'
SETGOVPAYMENT	Package 'HISTORICAL TABLES'
SETGOVRECOVERY	Package 'HISTORICAL TABLES'
SETINTERVENTION	Package 'SETTLEMENT_DATA'
SETINTERVENTIONRECOVERY	Package 'SETTLEMENT_DATA'
SETINTRAREGIONRESIDUES	Package 'SETTLEMENT_DATA'
SETIRAUCSURPLUS	Package 'SETTLEMENT_DATA'
SETIRFMRECOVERY	Package 'SETTLEMENT_DATA'
SETIRNSPSURPLUS	Package 'SETTLEMENT_DATA'
SETIRPARTSURPLUS	Package 'SETTLEMENT_DATA'
SETIRSURPLUS	Package 'SETTLEMENT_DATA'
SETLSHEDPAYMENT	Package 'SETTLEMENT_DATA'
SETLSHEDRECOVERY	Package 'SETTLEMENT_DATA'
SETLULOADPAYMENT	Package 'HISTORICAL TABLES'

SETLUNLOADRECOVERY	Package 'SETTLEMENT_DATA'
SETLUNLOADPAYMENT	Package 'SETTLEMENT_DATA'
SETLUNLOADRECOVERY	Package 'SETTLEMENT_DATA'
SETMARKETFEEES	Package 'SETTLEMENT_DATA'
SETREALLOCATIONS	Package 'SETTLEMENT_DATA'
SETRESERVERECOVERY	Package 'SETTLEMENT_DATA'
SETRESERVETRADER	Package 'HISTORICAL TABLES'
SETRESTARTPAYMENT	Package 'SETTLEMENT_DATA'
SETRESTARTRECOVERY	Package 'SETTLEMENT_DATA'
SETRPOWERPAYMENT	Package 'SETTLEMENT_DATA'
SETRPOWERRECOVERY	Package 'SETTLEMENT_DATA'
SETSMALLGENDATA	Package 'SETTLEMENT_DATA'
SETVICBOUNDARYENERGY	Package 'SETTLEMENT_DATA'
SETVICENERGYFIGURES	Package 'SETTLEMENT_DATA'
SETVICENERGYFLOW	Package 'SETTLEMENT_DATA'
SPDCONNECTIONPOINTCONSTRAINT	Package 'GENERIC_CONSTRAINT'
SPDINTERCONNECTORCONSTRAINT	Package 'GENERIC_CONSTRAINT'
SPDREGIONCONSTRAINT	Package 'GENERIC_CONSTRAINT'
SRA_CASH_SECURITY	Package 'IRAUCTION'
SRA_FINANCIAL_AUC_MARDETAIL	Package 'IRAUCTION'
SRA_FINANCIAL_AUC_MARGIN	Package 'IRAUCTION'
SRA_FINANCIAL_AUC_RECEIPTS	Package 'IRAUCTION'
SRA_FINANCIAL_AUCPAY_DETAIL	Package 'IRAUCTION'

SRA_FINANCIAL_AUCPAY_SUM	Package 'IRAUCTION'
SRA_FINANCIAL_RUNTRK	Package 'IRAUCTION'
SRA_OFFER_PRODUCT	Package 'IRAUCTION'
SRA_OFFER_PROFILE	Package 'IRAUCTION'
SRA_PRUDENTIAL_CASH_SECURITY	Package 'IRAUCTION'
SRA_PRUDENTIAL_COMP_POSITION	Package 'IRAUCTION'
SRA_PRUDENTIAL_EXPOSURE	Package 'IRAUCTION'
SRA_PRUDENTIAL_RUN	Package 'IRAUCTION'
STADUALLOC	Package 'PARTICIPANT_REGISTRATION'
STATION	Package 'PARTICIPANT_REGISTRATION'
STATIONOPERATINGSTATUS	Package 'PARTICIPANT_REGISTRATION'
STATIONOWNER	Package 'PARTICIPANT_REGISTRATION'
STATIONOWNERTRK	Package 'PARTICIPANT_REGISTRATION'
STPASA_CASESOLUTION	Package 'STPASA_SOLUTION'
STPASA_CONSTRAINTSOLUTION	Package 'STPASA_SOLUTION'
STPASA_INTERCONNECTORSOLN	Package 'STPASA_SOLUTION'
STPASA_REGIONSOLUTION	Package 'STPASA_SOLUTION'
STPASA_SYSTEMSOLUTION	Package 'HISTORICAL TABLES'
STPASA_UNITSOLUTION	Package 'HISTORICAL TABLES'
TRADINGINTERCONNECT	Package 'TRADING_DATA'

TRADINGLOAD	Package 'TRADING_DATA'
TRADINGPRICE	Package 'TRADING_DATA'
TRADINGREGIONSUM	Package 'TRADING_DATA'
TRANSMISSIONLOSSFACTOR	Package 'MARKET_CONFIG'
VALUATIONID	Package 'IRAUCTION'
VOLTAGE_INSTRUCTION	Package 'VOLTAGE_INSTRUCTIONS'
VOLTAGE_INSTRUCTION_TRK	Package 'VOLTAGE_INSTRUCTIONS'